

TIGER/Line[®] Shapefiles

2015

Technical Documentation



SUGGESTED CITATION

FILES:
2015 TIGER/Line Shapefiles (machine-readable data files) / prepared by the U.S. Census Bureau, 2015

TECHNICAL DOCUMENTATION:
2015 TIGER/Line Shapefiles Technical Documentation / prepared by the U.S. Census Bureau, 2015



U.S. Department of Commerce

Penny Pritzker, Secretary



Economic and Statistics Administration

Mark Doms,
Under Secretary for Economic Affairs

U.S. Census Bureau

John H. Thompson,
Director

Lisa Blumberman,
Associate Director for Decennial Census Programs

Nancy A. Potok
Deputy Director and Chief
Operating Officer

GEOGRAPHY DIVISION

Timothy F. Trainor, Chief

Andrea G. Johnson,
Assistant Division Chief for
Geographic Operations

Atri Kalluri,
Assistant Division Chief for Spatial Data
Systems and Database Management

Ama A. Danso,
Assistant Division Chief for
Address Software

Vacant,
Assistant Division Chief for
Production Workflow and IT Services

Vacant,
Assistant Division Chief for
Geographic Program Management

Michael R. Ratcliffe,
Assistant Division Chief for
Geocartographic Products and Criteria

Laura Waggoner,
Assistant Division Chief for
Geographic Partnerships

Gregory F. Hanks, Jr.,
Deputy Division Chief

Table of Contents

1.	Introduction.....	1-1
	1.1 What is a Shapefile?	1-1
	1.2 What are TIGER/Line Shapefiles?	1-1
	1.3 Relationship of the TIGER/Line Shapefiles to Census Statistical Data	1-1
	1.4 History and Sources of TIGER/Line Files and Shapefiles	1-1
	1.5 TIGER/Line Shapefile Legal Disclaimers	1-2
	1.6 Contact and Citation Information	1-2
2.	About the 2015 TIGER/Line Shapefiles	2-3
	2.1 What is in the 2015 TIGER/Line Shapefiles	2-3
	Table 1: 2015 Shapefile availability.....	2-5
	Table 2: 2015 Relationship file availability	2-6
	2.2 Structure and Format	2-6
	2.2.1 Structure	2-6
	2.2.2 File Naming Conventions	2-6
	2.2.3 Datum (GCS NAD 83).....	2-7
	2.2.4 Metadata	2-7
	2.2.5 Spatial Accuracy of Linear Features.....	2-8
	2.2.6 Coordinates.....	2-8
	2.2.7 Codes for Geographic Entities	2-8
	2.3 File Changes and Updates for the 2015 TIGER/Line Shapefiles	2-9
	2.3.1 List of files.....	2-9
	2.3.2 Boundary Changes.....	2-9
3.	Geographic Shapefile Concepts Overview	3-10
	3.1 American Indian / Alaska Native / Native Hawaiian (AIANNH) Areas	3-10
	3.1.1 Alaska Native Regional Corporations (ANRCs).....	3-10
	3.1.1.1 Alaska Native Regional Corporation (ANRC) Shapefile Record Layout (Current)	3-10
	3.1.2 American Indian/Alaska Native/Native Hawaiian (AIANNH) Areas.....	3-11
	Table 3: Census codes for each AIANNH area	3-14
	Table 4: Component types for AIANNH areas.....	3-15
	3.1.2.1 American Indian / Alaska Native / Native Hawaiian (AIANNH) Area National Shapefile Record Layout (Current)	3-15
	3.1.3 American Indian Tribal Subdivisions.....	3-16
	3.1.3.1 American Indian Tribal Subdivision (AITS) National Shapefile Record Layout.....	3-16
	3.1.4 Tribal Census Tract.....	3-17
	3.1.4.1 Tribal Census Tract National Shapefile (Current).....	3-18
	3.1.5 Tribal Block Group.....	3-19
	3.1.5.1 Tribal Block Group National Shapefile (Current).....	3-20

3.2 Blocks (Census Block)	3-20
Figure 1: Geographic Relationships - Small Area Statistical Entities; County-Census Tract-Block Group-Block.....	3-21
Figure 2: Geographic Relationships - Legal and Statistical Entities; County-County Subdivision-Place-Block	3-22
3.2.1 Block State-based Shapefile Record Layout (2010 Geography)	3-23
3.3 Block Groups	3-23
3.3.1 Block Group State-based Shapefile Record Layout (Current)	3-24
3.4 Census Tracts	3-25
3.4.1 Census Tract State-based Shapefile Record Layout (Current)	3-26
3.5 Congressional Districts	3-27
3.5.1 114th Congressional District National Shapefile Record Layout	3-27
3.6 Consolidated Cities	3-28
3.6.1 Consolidated City Shapefile Record Layout (Current)	3-28
3.7 Counties and Equivalent Entities	3-29
3.7.1 County and Equivalent Entity National Shapefile Record Layout (Current)	3-30
3.8 County Subdivisions	3-31
3.8.1 County Subdivision State-based Shapefile Record Layout (Current)	3-32
3.9 Estates 3-33	
3.9.1 Estate Shapefile (U.S. Virgin Islands Only) Record Layout (Current)	3-34
3.10 Hydrography (Area and Linear)	3-34
3.10.1 Area Hydrography County-based Shapefile Record Layout	3-35
3.10.2 Linear Hydrography County-based Shapefile Record Layout	3-35
3.11 Landmarks (Area and Point)	3-36
3.11.1 Area Landmark State-based Shapefile Record Layout	3-36
3.11.2 Point Landmark State-based Shapefile Record Layout	3-37
3.12 Linear Features	3-37
3.12.1 All Lines	3-38
3.12.1.1 All Lines County-based Shapefile Record Layout	3-38
3.12.2 Coastline	3-40
3.12.2.1 Coastline National Shapefile Record Layout	3-40
3.12.3 Roads 3-41	
3.12.3.1 Primary Roads National Shapefile Record Layout	3-41
3.12.3.2 Primary and Secondary Roads State-based Shapefile Record Layout	3-42
3.12.3.3 All Roads County-based Shapefile Record Layout	3-42
3.12.4 Address Ranges	3-42
3.12.4.1 Address Range Feature County-based Shapefile Record Layout	3-43
3.12.5 Railroads	3-44
3.12.5.1 Railroads National Shapefile Record Layout	3-45

3.13 Metropolitan and Micropolitan Statistical Areas and Related Statistical Areas	3-45
3.13.1 Combined New England City and Town Area (CNECTA) National Shapefile Record Layout (Current)	3-47
3.13.2 Combined Statistical Area (CSA) National Shapefile Record Layout (Current)	3-47
3.13.3 Metropolitan Division National Shapefile Record Layout (Current)	3-48
3.13.4 Metropolitan Statistical Area/Micropolitan Statistical Area (CBSA) National Shapefile Record Layout (Current)	3-49
3.13.5 New England City and Town Area (NECTA) National Shapefile Record Layout (Current)	3-50
3.13.6 New England City and Town Area (NECTA) Division National Shapefile Record Layout (Current)	3-50
3.14 Military Installations	3-51
3.14.1 Military Installation National Shapefile Record Layout	3-51
3.15 Places 3-52	
Figure 3: Geographic Corridors – Overview	3-54
Figure 4: Geographic Corridors Address Ranges.....	3-55
3.15.1 Place State-based Shapefile Record Layout (Current)	3-56
3.16 Public Use Microdata Areas (PUMAs)	3-57
3.16.1 Public Use Microdata Area (PUMA) State-based Shapefile Record Layout (2010 Census)	3-57
3.17 School Districts (Elementary, Secondary, and Unified)	3-58
3.17.1 Elementary School District State-based Shapefile Record Layout (Current)	3-59
3.17.2 Secondary School District State-based Shapefile Record Layout (Current)	3-60
3.17.3 Unified School District State-based Shapefile Record Layout (Current)	3-60
3.18 States and State Equivalent Entities	3-61
3.18.1 State and Equivalent Entity National Shapefile Record Layout (Current)	3-61
3.19 State Legislative Districts (Upper and Lower)	3-62
3.19.1 State Legislative District Lower Chambers (SLDL) State-based Shapefile Record Layout (Current)	3-63
3.19.2 State Legislative District Upper Chambers (SLDU) State-based Shapefile Record Layout (Current)	3-64
3.20 Subbarrio (Subminor Civil Division)	3-65
3.20.1 Subbarrio (Subminor Civil Division) State-based Shapefile Record Layout (Current)	3-65
3.21 Topological Faces (Polygons with All Geocodes)	3-66
3.21.1 Topological Faces (Polygons with All Geocodes) County-based Shapefile Record Layout (Current)	3-66
3.22 Urban Areas	3-69
3.22.1 Urban Area (UA) National Shapefile Record Layout (2010 Census)	3-69
3.23 ZIP Code Tabulation Areas (5-digit)	3-70
3.23.1 5-Digit ZIP Code Tabulation Area (ZCTA) National Shapefile Record Layout (2010 Census)	3-71

4.	Relationship File Concept Overview	4-72
	4.1 Address Ranges	4-72
	Figure 5: TIGER/Line Shapefiles Address Range Basics.....	4-73
	Table 6: Address range product comparison table	4-73
	Figure 6: TIGER/Line Shapefile Address Range Imputes - Before Split.....	4-76
	Figure 7: TIGER/Line Shapefile Address Range Imputes - After Split.....	4-76
	4.1.1 Address Ranges County-based Relationship File Record Layout (Current)	4-77
	4.2 Address Range-Feature Name Relationships	4-77
	4.2.1 Address Range-Feature Name County-based Relationship File Record Layout (Current)	4-77
	4.3 Feature Names	4-78
	4.3.1 Feature Names County-based Relationship File Record Layout (Current)	4-78
	4.4 Topological Faces-Area Landmark Relationships	4-79
	4.4.1 Topological Faces-Area Landmark County-based Relationship File Record Layout (Current)	4-79
	4.5 Topological Faces-Area Hydrography Relationships	4-79
	4.5.1 Topological Faces-Area Hydrography County-based Relationship File Record Layout (Current)	4-80
	4.6 Topological Faces-Military Installation Relationships	4-80
	4.6.1 Topological Faces-Military Installation National Relationship File Record Layout (Current)	4-80
5.	Instructions for Downloading the TIGER/Line Shapefiles	5-81
	5.1 Getting Started	5-81
	5.2 Website Interface	5-81
	Figure 8: Click the appropriate tab and then click on download to access the web interface.....	5-81
	Figure 9: An example of the menus available in the web interface.....	5-82
	5.3. Direct from FTP Site	5-82
	Figure 10: An example of the directory structure within the FTP site.....	5-83
	Table 7: 2015 TIGER/Line Shapefile file name definitions	5-83
	5.4 Connect via FTP Client	5-85
	5.5 Data.gov	5-85
6.	Useful Links	6-86
	6.1 User Notes	6-86
	6.2 Help Documents	6-86
	6.2.1 How to Guides	6-86
	6.2.2 Definitions	6-86
	6.3 Additional TIGER Products for use in a GIS	6-87
	6.3.1 TIGER Geodatabases	6-87

6.3.2 TIGER/Line Shapefiles and Geodatabases with Demographic Data	6-87
6.3.3 Cartographic Boundary Files	6-87
Appendix A. Pseudo-School Districts	104
Appendix B. Feature Name Directionals	108
Appendix C. Feature Name Qualifiers	109
Appendix D. Feature Name Types.....	110

1. Introduction

1.1 What is a Shapefile?

A shapefile is a geospatial data format for use in geographic information system (GIS) software. Shapefiles spatially describe vector data such as points, lines, and polygons, representing, for instance, landmarks, roads, and lakes. Esri created the format for use in their software, but the shapefile format works in additional GIS software as well.

1.2 What are TIGER/Line Shapefiles?

The TIGER/Line Shapefiles are the fully supported, core geographic product from the U.S. Census Bureau. They are extracts of selected geographic and cartographic information from the U.S. Census Bureau's Master Address File/Topologically Integrated Geographic Encoding and Referencing (MAF/TIGER) database. The shapefiles include information for the fifty states, the District of Columbia, Puerto Rico, and the Island areas (American Samoa, the Commonwealth of the Northern Mariana Islands, Guam, and the United States Virgin Islands). The shapefiles include polygon boundaries of geographic areas and features, linear features including roads and hydrography, and point features. They do not contain any sensitive data.

1.3 Relationship of the TIGER/Line Shapefiles to Census Statistical Data

The TIGER/Line Shapefiles contain a standard geographic identifier for each entity that links to the geographic identifier in the data from censuses and surveys. They do not include demographic data from surveys and censuses, such as the Decennial Census, Economic Census, American Community Survey, and the Population Estimates Program. Other, noncensus, data often has this standard geographic identifier as well. Data from many of the Census Bureau's surveys and censuses, including the geographic codes needed to join to the TIGER/Line Shapefiles, is available in American FactFinder (<http://factfinder2.census.gov>). For more information regarding the geographic entity codes, please refer to Section 2.2.7 Codes for Geographic Entities. For guides on using data from American FactFinder with the TIGER/Line Shapefiles, please see our help documents:

<http://www.census.gov/geo/education/howtos.html>.

In addition to the TIGER/Line Shapefiles, the Census Bureau creates additional shapefiles and geodatabases that include demographic data. These are as-is products and are created by Census Bureau staff as time permits. All shapefiles and geodatabases that have been pre-joined to demographic data are available at:

<http://www.census.gov/geo/maps-data/data/tiger-data.html>.

1.4 History and Sources of TIGER/Line Files and Shapefiles

The first release of the TIGER/Line Files was in 1989. These files provided the first nationwide street centerline coverage of the United States, Puerto Rico, and the Island Areas in a series of ASCII format fixed tables or record types. Initially, the Census Bureau used the U.S. Geological Survey (USGS) 1:100,000-scale Digital Line Graph (DLG), USGS 1:24,000-scale quadrangles, the Census Bureau's 1980 geographic base files (GBF/DIMEFiles), and a variety of miscellaneous maps for selected areas outside the contiguous 48 states to create the TIGER database (predecessor to the current MAF/TIGER database). Periodic versions of the TIGER/Line Files were released throughout the 1990s and 2000s in ASCII format. Beginning with the 2007 version, the format of the TIGER/Line Files changed from the ASCII file format to shapefile.

The Census Bureau continually makes additions and corrections to its database, mainly through partner supplied data, the use of aerial imagery, and fieldwork. The Census Bureau has numerous partner programs where federal, state, and local government partners' supply updates to boundaries, features, and addresses. In the 2000's, the Census Bureau underwent a major realignment of the TIGER database to improve the spatial accuracy of the road network. Since this realignment, the Census Bureau has added quality standards for data sources used to update the MAF/TIGER database.

1.5 TIGER/Line Shapefile Legal Disclaimers

No warranty, expressed or implied, is made with regard to the accuracy of the data in the TIGER/Line Shapefiles, and no liability is assumed by the United States Government in general, or the Census Bureau specifically, as to the positional or attribute accuracy of the data. The boundary information in the TIGER/Line Shapefiles is for statistical data collection and tabulation purposes only. Their depiction and designation for statistical purposes does not constitute a determination of jurisdictional authority or rights of ownership or entitlement and they are not legal land descriptions.

TIGER/Line® is a registered trademark of the Census Bureau. TIGER/Line cannot be used as or within the proprietary product names of any commercial product including or otherwise relevant to Census Bureau data and may only be used to refer to the nature of such a product. The Census Bureau requests that any repackaging of the TIGER/Line Shapefile data, documentation, and other files accompanying it for distribution include a conspicuously placed statement to this effect on the product's cover, the first page of the website, or elsewhere of comparable visibility. Further, Census Bureau trademarks, when used in reference to the nature of the product, should be accompanied by the ® (registered) symbol or ™ symbol, where convenient.

1.6 Contact and Citation Information

Questions about TIGER/Line Shapefiles obtained from the Census Bureau can be directed to the Geographic Products Branch, Geography Division, U.S. Census Bureau. The TIGER/Line Shapefiles are offered to the public free of charge through the Census Bureau's website. If you obtain the TIGER/Line Shapefiles from a third party, we recommend you contact that vendor for assistance as it is possible that they made changes to the files that we are unaware of or unable to support.

Geographic Products Branch
Geography Division, U.S. Census Bureau
4600 Silver Hill Road
Washington, DC 20233-7400
Office: (301) 763-1128
E-mail: geo.tiger@census.gov

Copyright protection is not available for any work of the United States Government (Title 17 U.S.C., Section 105). Thus, you are free to reproduce census materials as you see fit. We would ask, however, that you [cite](#) the Census Bureau as the source.

2. About the 2015 TIGER/Line Shapefiles

2.1 What is in the 2015 TIGER/Line Shapefiles

The 2015 TIGER/Line Shapefiles contain current geography for the United States, the District of Columbia, Puerto Rico, and the Island areas. Current geography in the 2015 TIGER/Line Shapefiles generally reflects the boundaries of governmental units in effect as of January 1, 2015, and other legal and statistical area boundaries that have been adjusted and/or corrected since the 2010 Census. This vintage includes boundaries of governmental units that match the data from the surveys that use 2015 geography, such as the 2015 Population Estimates and the 2015 American Community Survey.

The 2015 TIGER/Line Shapefiles contain the geographic extent and boundaries of both legal and statistical entities. A legal entity is a geographic entity whose boundaries, name, origin, and area description result from charters, laws, treaties, or other administrative or governmental action. A statistical entity is any geographic entity or combination of entities identified and defined solely for the tabulation and presentation of data. Statistical entity boundaries are not legally defined and the entities have no governmental standing.

In addition to geographic boundaries, the 2015 TIGER/Line Shapefiles also include geographic feature shapefiles and relationship files. Feature shapefiles represent the point, line and polygon features in the MAF/TIGER database, like roads and rivers. Relationship files are database files that contain additional attribute information that can be joined to the shapefiles. In this release, both the feature shapefiles and relationship files reflect updates made in the database through May 2015.

To see how the geographic entities relate to one another, please see our geographic hierarchy diagrams here:

<http://www.census.gov/geo/reference/hierarchy.html>.

The legal entities included in these shapefiles are:

- American Indian off-reservation trust lands
- American Indian reservations (both federally and state-recognized)
- American Indian tribal subdivisions (within legal American Indian areas)
- Alaska Native Regional Corporations
- Congressional districts – 114th Congress
- Consolidated cities
- Counties and equivalent entities (except census areas in Alaska)
- Estates (U.S. Virgin Islands only)
- Hawaiian home lands
- Incorporated places
- Minor civil divisions (MCDs, such as towns and townships in the Northeast and Midwest)
- School districts (elementary, secondary, and unified)
- States and equivalent entities
- State legislative districts (upper and lower chambers)
- Subbarrios (Subminor civil divisions) (Puerto Rico only)

The statistical entities included in these shapefiles are:

- Alaska Native village statistical areas
- American Indian/Alaska Native statistical areas

American Indian tribal subdivisions (within Oklahoma tribal statistical areas)
Block groups
Census areas (statistical county equivalents in Alaska)
Census blocks
Census county divisions (CCDs), census subareas (in Alaska), and unorganized territories (statistical county subdivisions)
Census designated places (CDPs)
Census tracts
Combined New England city and town areas
Combined statistical areas
Metropolitan and micropolitan statistical areas and related statistical areas
Metropolitan divisions
New England city and town areas
New England city and town area divisions
Oklahoma tribal statistical areas
Public use microdata areas (PUMAs)
State designated tribal statistical areas
Tribal designated statistical areas
Urban areas
ZIP Code tabulation areas (ZCTAs)

The feature shapefiles and relationship files are:

Address range-feature
Address range-feature name relationship file
Address ranges
All lines (called Edges)
All roads
Area hydrography
Area landmark
Coastline
Feature names relationship file
Linear hydrography
Point landmark
Primary and secondary roads
Primary roads
Topological faces (polygons with all geocodes)
Topological faces – area landmark relationship file
Topological faces – area hydrography relationship file
Topological faces – military installations relationship file

For the 2015 TIGER/Line Shapefiles, the geographic entities and features available in nation-, state-, or county-based files can be found in Table 1.

Table 1: 2015 Shapefile availability

Layer	Nation- Based File	State- Based File	County- Based File
Address Range-Feature			X
Alaska Native Regional Corporation		X	
All Lines (Edges)			X
All Roads			X
American Indian Tribal Subdivision	X		
American Indian/Alaska Native/Native Hawaiian Areas	X		
Area Hydrography			X
Area Landmark		X	
Block		X	
Block Group		X	
Census Tract		X	
Coastline	X		
Combined New England City and Town Area	X		
Combined Statistical Area	X		
Congressional District – 114th Congress	X		
Consolidated City		X	
Core Based Statistical Areas	X		
County and Equivalent	X		
County Subdivision		X	
Elementary School District		X	
Estates		X	
Linear Hydrography			X
Metropolitan Divisions	X		
Military Installation	X		
New England City and Town Area	X		
New England City and Town Division	X		
Place		X	
Point Landmark		X	
Primary and Secondary Roads		X	
Primary Roads	X		
Public Use Microdata Area		X	
Rails	X		
Secondary School District		X	
State and Equivalent	X		
State Legislative District – Lower Chamber		X	
State Legislative District – Upper Chamber		X	
Subbarrio		X	
Topological Faces (Polygons with All Geocodes)			X
Tribal Block Group	X		
Tribal Census Tract	X		
Unified School District		X	
Urban Areas	X		
ZIP Code Tabulation Area	X		

For the 2015 TIGER/Line Shapefiles, the relationship files available in nation-, state-, or county-based files can be found in Table 2.

Table 2: 2015 Relationship file availability

Layer	Nation-Based File	State-Based File	County-Based File
Address Range-Feature Name			X
Address Ranges			X
Feature Names			X
Topological Faces – Area Landmark		X	
Topological Faces – Area Hydrography			X
Topological Faces – Military Installations	X		

2.2 Structure and Format

2.2.1 Structure

The 2015 TIGER/Line Shapefiles and associated relationship files are offered in a compressed format. One zipped file is available for each layer, with a file extension of .zip. Each zipped shapefile consists of the following seven files:

- .shp – the feature geometry
- .shx – the index of the feature geometry
- .dbf – the tabular attribute information
- .prj – the coordinate system information
- .shp.xml – the Federal Geographic Data Committee (FGDC) metadata
- .shp.iso.xml - the International Organization for Standardization (ISO 191) metadata
- .shp.ea.iso.xml - the ISO 191 (entity and attribute) metadata

Each zipped relationship file consists of the following four files:

- .dbf – the tabular attribute information
- .dbf.xml – the Federal Geographic Data Committee (FGDC) metadata
- .dbf.iso.xml - the International Organization for Standardization (ISO 191) metadata
- .dbf.ea.iso.xml - the ISO 191 (entity and attribute) metadata

2.2.2 File Naming Conventions

The name of each file is:

tl_2015_<extent>_<layer>.<ext>

Where:

tl = TIGER/Line
2015 = the version of the files

<extent> = parent geography entity ID code (variable length of two to five characters)
The entity ID code identifies the geographic extent by specific entity for which the file contains data. It is of variable length depending on the type of file:

Nation-based: 2-character abbreviation – “us”
State-based: 2-character numeric state FIPS code
County-based: 5-character numeric county FIPS code

<layer> = layer tag of variable length
The layer tag specifies the type of geography or feature the file contains.

<ext> = the file extension

Examples:

Nation-based shapefile: County and Equivalent shapefile
File Name: tl_2015_us_county.shp

State-based shapefile: State and Equivalent shapefile for Maryland
File Name: tl_2015_24_state.shp

County-based shapefile: All Lines shapefile for Cayuga County, New York
File Name: tl_2015_36011_edges.shp

2.2.3 Datum (GCS NAD 83)

Each shapefile contains a .prj file that contains the GIS industry standard well-known text (WKT) format to describe the coordinate system/projection/datum information for each shapefile. All Census Bureau generated shapefiles are in Global Coordinate System North American Datum of 1983 (GCS NAD83). Each .prj file contains the following:

```
GEOGCS["GCS_North_American_1983",DATUM["D_North_American_1983",SPHEROID["GRS_1980",6378137,298.257222101]],PRIMEM["Greenwich",0],UNIT["Degree",0.017453292519943295]]
```

2.2.4 Metadata

Metadata are organized data files used to capture the basic descriptive characteristics about the data. For example, metadata will describe the quality, purpose, spatial extent, and history of a particular dataset. The metadata files are compatible with a text editor, web browser, or Esri's ArcCatalog. The TIGER/Line Shapefiles metadata provide a detailed description of the TIGER/Line Shapefiles and relationship files. This includes publication date, contact information, and all of the valid attribute values and descriptions. Users should refer to the metadata files for extensive documentation about the contents of the shapefiles and relationship files. The All Lines metadata also contains a Spatial Metadata Identifier (SMID), which identifies the source of the coordinates for each edge and the horizontal spatial accuracy information for a particular line. Please note that the horizontal spatial accuracy refers only to those edges identified as matched to the source with that accuracy. It is not the spatial accuracy of the All Lines shapefile as a whole. For more information regarding the All Lines Shapefile, please refer to Section 3.12, Linear Features.

Metadata are provided in two formats for each shapefile and relationship file in Extensible Markup Language (XML) format.

- Federal Geographic Data Committee (FGDC) Content Standard for Digital Geospatial Metadata (CSDGM)*
 - shp.xml
 - dbf.xml
- International Organization for Standardization (ISO 191) Content Standard for Digital Geospatial Metadata
 - .shp.iso.xml and .shp.ea.iso.xml
 - .dbf.iso.xml and .dbf.ea.iso.xml

* Please note that in order to see all of the metadata element values, the FGDC CSDGM stylesheet must be specified when using Esri's ArcCatalog.

2.2.5 Spatial Accuracy of Linear Features

In order to maintain a current geographic database from which to extract the TIGER/Line Shapefiles, the Census Bureau uses various internal and external processes to update the MAF/TIGER database. While it has made a reasonable and systematic attempt to gather the most recent information available about the features each file portrays, the Census Bureau cautions users that the files are no more complete than the source documents used in their compilation, the vintage of those source documents, and the translation of the information on those source documents.

2.2.6 Coordinates

Coordinates in the TIGER/Line Shapefiles have six decimal places, but the positional accuracy of these coordinates may not be as great as the six decimal places suggest. The spatial accuracy varies with the source materials used. The Census Bureau cannot specify the spatial accuracy of features changed or added by its field staff or through local updates, features derived from the GBF/DIME Files (TIGER's predecessor in 1970 and 1980), or other map or digital sources. Thus, the level of spatial accuracy in the TIGER/Line Shapefiles makes them unsuitable for high-precision measurement applications such as engineering problems, property transfers, or other uses that might require highly accurate measurements of the earth's surface. No warranty, expressed or implied, is made with regard to the accuracy of these data, and no liability is assumed by the U.S. Government in general or the Census Bureau specifically, as to the spatial or attributes accuracy of the data.

2.2.7 Codes for Geographic Entities

The 2015 TIGER/Line Shapefiles include the American National Standards Institute (ANSI) codes to identify both legal and statistical entities. The ANSI codes are a standardized set of numeric or alphabetic codes issued by the American National Standards Institute (ANSI) to ensure uniform identification of geographic entities through all federal government agencies.

The ANSI publications include both the Federal Information Processing Series (FIPS) codes and the United States Geological Survey's Geographic Names Information System (GNIS) codes. The FIPS codes appear in the 2015 TIGER/Line Shapefiles in fields such as "STATEFP", where "FP" indicates that the field contains a FIPS code. The GNIS codes are a permanent numeric identifier of up to eight digits. The GNIS codes appear in fields such as "STATENS", where "NS" (National Standard) indicates that the field contains a GNIS code. The Census Bureau stores the GNIS code as a fixed-width string; the official code is a numeric value without leading zeroes. The GNIS code is available beginning in the 2010 TIGER/Line Shapefiles. For geographic entities not covered by ANSI, the Census Bureau assigns a code and these appear in fields such as "TRACTCE", where "CE" stands for Census. Finally, state-submitted codes end in "ST", such as "SLDLST", and local education agency codes end in "LEA", as in "ELSDLLEA".

For more information about ANSI codes, please visit:
<http://www.census.gov/geo/reference/ansi.html>.

2.3 File Changes and Updates for the 2015 TIGER/Line Shapefiles

2.3.1 List of files

The 2015 TIGER/Line Shapefiles includes the following updates:

- The following shapefiles may have boundary updates:
 - County and equivalents
 - Places
 - County subdivisions

2.3.2 Boundary Changes

Most of the boundaries of federally recognized American Indian Reservations and off-reservation trust lands, tribal subdivisions, states and equivalent entities, counties and equivalent entities, minor civil divisions (MCDs), consolidated cities, and incorporated places generally are those that were legally in effect as of January 1, 2015. The Boundary and Annexation Survey (BAS) collects boundaries of legal areas.

For more information about the BAS, please visit:
<http://www.census.gov/geo/partnerships/bas.html>.

For more information about specific boundary changes, please visit:
http://www.census.gov/geo/partnerships/bas/bas_newannex.html.

For nearly all statistical areas, the boundaries shown are those in effect at the time of the 2010 Census. However, there are a few exceptions. Current geography may differ from 2010 Census geography due to feature updates that cause boundary shifts. For example, if a street feature that acts as a census tract boundary is moved, then the census tract boundary will move as well. In addition, census tract boundaries may change to maintain comparability with related geographies, such as incorporated places. If a census tract boundary is based on an incorporated place boundary, and the place boundary changes, the census tract boundary may change if the population affected in the census tract is low. Census designated places (CDPs) may also change throughout the decade. As time permits, new CDPs are added to our database. In addition, because unorganized territories and CDPs occupy the same level of geography as legal MCDs and incorporated places, updates to the legal boundaries may affect the current boundaries for some of these entities, including the elimination of some of the statistical entities.

3. Geographic Shapefile Concepts Overview

The following sections describe the geographic entity type displayed in each shapefile, as well as the record layout for each file. Each entity type is listed in alphabetical order. A listing of all available shapefiles, including vintage and geographic level (state, county, and national), precedes the description of the entity type.

3.1 American Indian / Alaska Native / Native Hawaiian (AIANNH) Areas

3.1.1 Alaska Native Regional Corporations (ANRCs)

Alaska Native Regional Corporations geography and attributes are available for Alaska in the following shapefile:

Alaska Native Regional Corporation (ANRC) State Shapefile (Current)

ANRCs are corporations created according to the Alaska Native Claims Settlement Act (Pub. L. 92–203, 85 Stat. 688 (1971); 43 U.S.C. 1602 et seq. (2000)). They are organized under the laws of the State of Alaska as “Regional Corporations,” to conduct both the for-profit and non-profit affairs of Alaska Natives within defined regions of Alaska. The Census Bureau treats ANRCs as legal geographic entities. Twelve ANRCs cover the entire State of Alaska except for the area within the Annette Island Reserve (an American Indian Reservation under the governmental authority of the Metlakatla Indian Community). There is a thirteenth ANRC that represents the eligible Alaska Natives living outside of Alaska that are not members of any of the twelve ANRCs within the State of Alaska. Because it has no defined geographic extent, this thirteenth ANRC does not appear in the TIGER/Line Shapefiles and the Census Bureau does not provide data for it. The Census Bureau offers representatives of the twelve ANRCs the opportunity to review and update the ANRC boundaries. ANRCs are represented by a 5-character FIPS code unique within Alaska and a nationally unique 8-character National Standard (GNIS) code.

3.1.1.1 Alaska Native Regional Corporation (ANRC) Shapefile Record Layout (Current)

File Name: tl_2015_02_anrc.shp

Field	Length	Type	Description
STATEFP	2	String	Current state FIPS code
ANRCFP	5	String	Current Alaska Native Regional Corporation FIPS code
ANRCNS	8	String	Current Alaska Native Regional Corporation GNIS code
GEOID	7	String	Alaska Native Regional Corporation identifier; a concatenation of Current state FIPS code and Alaska Native Regional Corporation code
NAME	100	String	Current Alaska Native Regional Corporation name
NAMELSAD	100	String	Current name and the translated legal/statistical area description for Alaska Native Regional Corporation

Field	Length	Type	Description
LSAD	2	String	Current legal/statistical area description code for Alaska Native Regional Corporation
CLASSFP	2	String	Current FIPS class code
MTFCC	5	String	MAF/TIGER feature class code (G2200)
FUNCSTAT	1	String	Current functional status
ALAND	14	Number	Current land area
AWATER	14	Number	Current water area
INTPTLAT	11	String	Current latitude of the internal point
INTPTLON	12	String	Current longitude of the internal point

3.1.2 American Indian/Alaska Native/Native Hawaiian (AIANNH) Areas

American Indian, Alaska Native, and Native Hawaiian area geography and attributes are available in the following shapefile:

American Indian/Alaska Native/Native Hawaiian (AIANNH) Area National Shapefile (Current)

This shapefile contain both legal and statistical American Indian, Alaska Native, and Native Hawaiian entities for which the Census Bureau publishes data. The legal entities consist of federally recognized American Indian reservations and off-reservation trust land areas, state-recognized American Indian reservations, and Hawaiian home lands (HHLs). American Indian tribal subdivisions and Alaska Native Regional Corporations (ANRCs) are additional types of legal entities, but are displayed in separate shapefiles discussed in this chapter. The statistical entities displayed in these shapefiles are Alaska Native village statistical areas (ANVSAs), Oklahoma tribal statistical areas (OTSAs), tribal designated statistical areas (TDSAs), and state designated tribal statistical areas (SDTSAs). Definitions of each area are provided later in this section.

The American Indian/Alaska Native/Native Hawaiian (AIANNH) Area shapefiles contain a unique polygon record for each American Indian reservation or off-reservation trust land, Hawaiian home land, Alaska Native Village statistical area, and American Indian statistical geographic entity. For example, the Fort Peck Indian Reservation will have two records: one for the reservation portion and another for the off-reservation trust land portion. Entities with only a single component will contain a single record. There is always a single record for a Hawaiian home land, Alaska Native Village statistical area, American Indian statistical geographic entity, reservations without any associated off-reservation trust land, and entities that consist only of off-reservation trust land.

American Indian, Alaska Native, and Native Hawaiian areas cannot overlap another tribal entity. An exception is made for tribal subdivisions, which subdivide some American Indian entities, and Alaska Native village statistical areas (ANVSAs), which exist within Alaska Native Regional Corporations (ANRCs). In cases where more than one tribe claims jurisdiction over an area, the Census Bureau creates a joint-use area as a separate entity to define this area of dual claims.

Legal Entity Definitions

American Indian Reservations—Federal (federal AIRs) are areas that have been set aside by the United States for the use of federally recognized tribes. The exterior boundaries of federal AIRs are defined in tribal treaties, agreements, executive orders, federal statutes, secretarial orders, and/or judicial determinations. The Census Bureau recognizes federal reservations as territory over which American

Indian tribes have governmental authority. These entities are known as colonies, communities, Indian colonies, Indian communities, Indian Rancherias, Indian Reservations, Indian villages, pueblos, rancherias, ranches, reservations, reserves, settlements, villages, or other descriptions. The Bureau of Indian Affairs within the U.S. Department of Interior maintains a list of federally recognized tribal governments that is published regularly in the Federal Register. The Census Bureau contacts representatives of these federally recognized American Indian tribal governments to identify the boundaries for federal reservations. Federal reservations may cross state, county, county subdivision, and/or place boundaries.

To obtain the list of federally recognized tribal governments and for more detailed information regarding tribal governments, please visit the Bureau of Indian Affairs website at: <http://www.bia.gov/>.

Each federal AIR and reservation equivalent joint-use area is assigned a nationally unique 4-character census code ranging from 0001 through 4999. These census codes are assigned in alphabetical order of AIR names nationwide, except that joint-use areas appear at the end of the code range (4900 to 4999). Federal AIRs and reservation equivalent joint-use areas are also assigned a nationally unique 8-character National Standard (GNIS) code.

American Indian Reservations—State (state AIRs) are established by some state governments for tribes recognized by the state. A governor-appointed state liaison provides the names and boundaries for state-recognized American Indian reservations to the Census Bureau. State reservations may cross county, county subdivision, and/or place boundaries.

Each state American Indian reservation is assigned a nationally unique 4-character census code ranging from 9000 through 9499. Each state AIR also is assigned a nationally unique 8-character National Standard (GNIS) code.

American Indian Trust Lands are areas for which the United States holds title in trust for the benefit of a tribe (tribal trust land) or for an individual American Indian tribal member (individual trust land or allotment). Trust lands may be located on (on-reservation) or off an American Indian reservation (off-reservation). The Census Bureau recognizes and tabulates data for reservations and off-reservation trust lands (ORTLs) because American Indian tribes have governmental authority over these lands. Tribal governmental authority generally is not attached to lands located off the reservation until the lands are placed in trust status. In Census Bureau data tabulations, ORTLs are always associated with a specific federally recognized reservation and/or tribal government. A tribal government appointed liaison provides the name and boundaries of their ORTLs. The Census Bureau does not identify on-reservation trust land, fee land (or land in fee simple status), or restricted fee lands as specific geographic categories and they are not identified as such in the TIGER/Line Shapefiles.

Hawaiian Home Lands (HHLs) are areas held in trust for Native Hawaiians by the State of Hawaii, according to the Hawaiian Homes Commission Act of 1920, as amended. Based on a compact between the federal government and the new State of Hawaii in 1959, the Hawaii Admission Act vested land title and responsibility for the program with the State. An HHL is not a governmental unit; rather, a home land is a tract of land with a legally defined boundary that is owned by the state, which, as authorized by the Act, may lease to one or more Native Hawaiians for residential, agricultural, commercial, industrial, pastoral, and/or any other activities authorized by state law. The Census Bureau obtains the names and boundaries for Hawaiian home lands from State officials. The names of the home lands are based on the traditional ahupua'a names of the Crown and government lands of the Kingdom of Hawaii from which the lands were designated or from the local name for an area.

Being lands held in trust, Hawaiian home lands are treated as equivalent to off-reservation trust land areas with an AIANNH area trust land indicator coded as "T". Each Hawaiian home land area is assigned a nationally unique 4-character census code ranging from 5000 through 5499 based on the alphabetical sequence of each HHL name. Each Hawaiian home land is also assigned a 5-character FIPS code in alphabetical order within the State of Hawaii and a nationally unique 8-character National Standard (GNIS) code.

Joint-Use Areas means an area that is administered jointly and/or claimed by two or more federally recognized American Indian tribes. The Census Bureau designates both legal and statistical joint-use areas as unique geographic entities for presenting statistical data. Joint-use areas only apply to overlapping federally recognized American Indian reservations and/or off-reservation trust lands.

Each is assigned a nationally unique 4-character census code ranging from 4800 through 4999 and a nationally unique 8-character National Standard (GNIS) code.

Statistical Entity Definitions

Alaska Native Village Statistical Areas (ANVSAs) are a statistical geographic entity that represents the residences, permanent and/or seasonal, for Alaska Natives who are members of or are primarily receiving governmental services from the defining Alaska Native village (ANV) and that are located within the region and vicinity of the ANV's historic and/or traditional location. ANVSAs are intended to represent the relatively densely settled portion of each ANV and ideally should include only an area where Alaska Natives, especially members of the defining ANV, represent a significant proportion of the population during at least one season of the year (at least three consecutive months). ANVSAs are delineated or reviewed by officials of the ANV or, if no ANV official chose to participate in the delineation process, officials of the non-profit Alaska Native Regional Corporation (ANRC) in which the ANV is located. In some cases, if neither the ANV nor ANRC official chose to participate in the delineation process, the Census Bureau reviewed and delineated the ANVSA. An ANVSA may not overlap the boundary of another ANVSA or an American Indian reservation.

Each ANVSA is assigned a nationally unique 4-character census code ranging from 6000 to 7999 based on the alphabetical sequence of each ANVSA's name. Each ANVSA is also assigned a nationally unique 8-character National Standard (GNIS) code.

Joint-Use Areas means an area is administered jointly and/or claimed by two or more American Indian tribes. The Census Bureau designates both legal and statistical joint-use areas as unique geographic entities for presenting statistical data. Statistical joint-use areas only apply to overlapping Oklahoma tribal statistical areas.

Oklahoma Tribal Statistical Areas (OTSAs) are statistical entities identified and delineated by the Census Bureau in consultation with federally recognized American Indian tribes that formerly had a reservation in Oklahoma. The boundary of an OTSA is generally that of the former reservation in Oklahoma, except where modified by agreements with neighboring federally recognized tribes that are eligible to delineate an OTSA. Tribal subdivisions can exist within the statistical Oklahoma tribal statistical areas. Each OTSA is assigned a nationally unique 4-character census code ranging from 5500 through 5999 based on the alphabetical sequence of each OTSA's name, except that the joint-use areas appear at the end of the code range. Each OTSA also is assigned a nationally unique 8-character National Standard (GNIS) code.

State Designated Tribal Statistical Areas (SDTSAs) are statistical entities for state-recognized American Indian tribes that do not have a state-recognized reservation. SDTSAs are identified and delineated for

the Census Bureau by a state liaison identified by the governor's office in each state. SDTSAs are generally a compact and contiguous area that contains a concentration of people who identify with a state-recognized American Indian tribe and in which there is structured or organized tribal activity. An SDTSA may not be located in more than one state unless the tribe is recognized by both states and it may not include area within any other AIANNH areas. Note that for Census 2000 these areas were termed State Designated American Indian Statistical Areas (SDAISAs); the term was changed to bring consistency to tribal statistical area terms.

Each SDTSA is assigned a nationally unique 4-character census code ranging from 9500 through 9998 in alphabetical sequence of SDTSA names nationwide. Each SDTSA also is assigned a nationally unique 8-character National Standard (GNIS) code.

Tribal Designated Statistical Areas (TDSAs) are statistical entities identified and delineated for the Census Bureau by federally recognized American Indian tribes that do not currently have a reservation or off-reservation trust land. A TDSA is intended to be comparable to the AIRs within the same state and/or region, especially those for tribes that are of similar size. A TDSA is generally a compact and contiguous area that contains a concentration of individuals who identify with the delineating federally recognized American Indian tribe and in which there is structured or organized tribal activity. A TDSA may be located in more than one state, but it may not include area within any other AIANNH areas. Each TDSA is assigned a nationally unique 4-character census code ranging from 8000 through 8999 in alphabetical sequence of TDSA names nationwide. Each TDSA is also assigned a nationally unique 8-character National Standard (GNIS) code.

AIANNH Area Codes—the American Indian, Alaska Native, and Native Hawaiian (AIANNH) areas are represented in the TIGER/Line Shapefiles by a 4-character census code field, and a single alphabetic character AIANNH area reservation/statistical area or off-reservation trust land (ORTL) indicator field, shown as COMPTYP (component type). The census codes are assigned in alphabetical order in assigned ranges by AIANNH area type nationwide, except that joint-use areas appear at the end of their applicable code range. ORTLs are assigned the same code as the reservation with which they are associated. ORTLs associated with tribes that do not have a reservation are assigned codes based on their tribal name. There is one record created for each unique combination of AIANNH code and component type. Each AIANNH area also is assigned a nationally unique 8-character National Standard (GNIS) code.

The type of AIANNH area can be identified either by its census code (AIANNHCE), its MAF/TIGER feature class code (MTFCC), or by its FIPS class code (CLASSFP). The range of census codes allocated to each AIANNH area and the valid FIPS class code(s) associated with each are in Table 3.

Table 3: Census codes for each AIANNH area

Type	Census Code Range	Valid FIPS Class Codes	MTFCCs
Federal AIR or ORTL	0001 to 4899	**D2, **D3, **D5, **D8	*G2101, *G2102
Federal AIR/ORTL joint-use area	4900 to 4999	D0	G2170
Hawaiian home land	5000 to 5499	F1	G2120
OTSA	5500 to 5899	D6	G2140
OTSA joint-use area	5900 to 5999	D0	G2170
ANVSA	6000 to 7999	E1	G2130
TDSA	8000 to 8999	D6	G2160
State AIR	9000 to 9499	D4	G2101
SDTSA	9500 to 9998	D9	G2150

Notes:

- G2101 can represent both federally and state-recognized areas; the recognition level can be determined using the federal/state recognition flag (AIANNHR) field where “F” is federally recognized and “S” is state-recognized.
- Joint-use areas are identified uniquely by MTFCC G2170. An “A” in the functional status (FUNCSTAT) field identifies federal AIR/ORTL joint-use areas, while an “S” in the field represents joint-use OTSAs.

*G2101: Reservation or AIAN statistical entity

*G2102: American Indian ORTL or Hawaiian home land

**D2: Legal federally recognized American Indian area consisting of reservation only; D3: Legal federally recognized American Indian area consisting of off-reservation trust land only; D5: The legal off-reservation trust land portion of a federally recognized American Indian area with both a reservation and trust land; D8: The legal reservation portion of a federally recognized American Indian entity with both a reservation and trust land.

Table 4: Component types for AIANNH areas

Type	Component Type (COMPTYP)
American Indian Trust Land	T
Reservation or Statistical Entity	R

3.1.2.1 American Indian / Alaska Native / Native Hawaiian (AIANNH) Area National Shapefile Record Layout (Current)

File Name: tl_2015_us_aiannh.shp

Field	Length	Type	Description
AIANNHCE	4	String	Current American Indian/Alaska Native/Native Hawaiian area census code
AIANNHNS	8	String	Current American Indian/Alaska Native/Native Hawaiian area GNIS code
GEOID	5	String	American Indian/Alaska Native/Native Hawaiian area identifier; a concatenation of Current American Indian/Alaska Native/Native Hawaiian area census code and reservation/statistical area or off-reservation trust land Hawaiian home land indicator
NAME	100	String	Current American Indian/Alaska Native/Native Hawaiian area name
NAMELSAD	100	String	Current name and the translated legal/statistical area description for American Indian/Alaska Native/Native Hawaiian area

Field	Length	Type	Description
LSAD	2	String	Current legal/statistical area description code for American Indian/Alaska Native/Native Hawaiian area
CLASSFP	2	String	Current FIPS class code
COMPTYP	1	String	Current American Indian/Alaska Native/Native Hawaiian area reservation/statistical area or off-reservation trust land Hawaiian home land indicator
AIANNHR	1	String	Current American Indian/Alaska Native/Native Hawaiian area federal/state recognition flag
MTFCC	5	String	MAF/TIGER feature class code
FUNCSTAT	1	String	Current functional status
ALAND	14	Number	Current land area
AWATER	14	Number	Current water area
INTPTLAT	11	String	Current latitude of the internal point
INTPTLON	12	String	Current longitude of the internal point

3.1.3 American Indian Tribal Subdivisions

American Indian Tribal Subdivision geography and attributes are available in the following shapefile:

American Indian Tribal Subdivision (AITS) National Shapefile (Current)

American Indian Tribal Subdivisions (AITS) are legally defined administrative subdivisions of federally recognized American Indian reservations and/or off-reservation trust lands or Oklahoma tribal statistical areas (OTSAs). Tribal subdivisions are known as additions, administrative areas, areas, chapters, county districts, districts, or segments. These entities are internal units of self-government or administration that serve social, cultural, and/or economic purposes for the American Indians on the reservations, off-reservation trust lands, or OTSAs. The Census Bureau obtains the boundary and name information for tribal subdivisions from the federally recognized tribal governments.

American Indian Tribal Subdivision Codes are represented in the TIGER/Line Shapefiles by a 3-character census code. The Census Bureau assigns the 3-character American Indian tribal subdivision code alphabetically in order and uniquely within each American Indian reservation and/or associated off-reservation trust land or Oklahoma tribal statistical area (OTSA). Each AITS is also assigned a nationally unique 8-character National Standard (GNIS) code.

3.1.3.1 American Indian Tribal Subdivision (AITS) National Shapefile Record Layout

File Name: tl_2015_us_aitsn.shp

Field	Length	Type	Description
-------	--------	------	-------------

Field	Length	Type	Description
AIANNHCE	4	String	Current American Indian/Alaska Native/Native Hawaiian area census code
TRSUBCE	3	String	Current American Indian tribal subdivision census code
TRSUBNS	8	String	Current American Indian tribal subdivision GNIS code
GEOID	7	String	American Indian tribal subdivision identifier; a concatenation of Current American Indian/Alaska Native/Native Hawaiian area census code and American Indian tribal subdivision census code
NAME	100	String	Current American Indian tribal subdivision name
NAMELSAD	100	String	Current name and the translated legal/statistical area description for American Indian tribal subdivision
LSAD	2	String	Current legal/statistical area description code for American Indian tribal subdivision
CLASSFP	2	String	Current FIPS class code
MTFCC	5	String	MAF/TIGER feature class code (G2300)
FUNCSTAT	1	String	Current functional status
ALAND	14	Number	Current land area
AWATER	14	Number	Current water area
INTPTLAT	11	String	Current latitude of the internal point
INTPTLON	12	String	Current longitude of the internal point

3.1.4 Tribal Census Tract

Tribal census tract geography and attributes are available in the following shapefile:

Tribal Census Tract National Shapefile (Current)

Tribal census tracts are relatively small statistical subdivisions of an American Indian reservation and/or off-reservation trust land (ORTL) and were defined by federally recognized tribal government officials in the Census Bureau's Tribal Statistical Areas Program (TSAP) for the 2010 Census. If a tribal government declined to participate in TSAP, the Census Bureau delineated tribal census tracts on the American Indian reservation and/or ORTL. Tribal census tracts are conceptually similar and equivalent to standard census tracts. Unlike standard census tracts, however, tribal census tracts may cross state, county, and standard census tract boundaries.

Tribal census tracts generally have at least 1,200 persons or 480 housing units, and no more than 8,000 persons or 3,200 housing units, with an optimal size of 4,000 persons or 1,600 housing units. Many American Indian reservations and/or off-reservation trust lands have less than 2,400 persons and/or 960 housing units; in those cases, one tribal census tract was delineated that covers the entire American Indian reservation and/or off-reservation trust land, since the area did not have enough population or housing units to meet the minimum population and housing requirements for more than one tribal census tract.

A tribal census tract usually covers a contiguous area but in some cases may consist of more than one discrete area. Tribal census tracts nest within individually federally recognized American Indian reservations and/or ORTLs. In some cases, an American Indian reservations and/or ORTL might be discontinuous, so the tribal census tracts will be as well.

Tribal Census Tracts Codes—Tribal census tracts have a 4-character basic name/code plus a 2-character suffix, which may be utilized if the tribal census tract is split in the future. (Because 2010 is the first Census for which this coding scheme was used, no tribal census tracts currently have suffixes, in other words they all have a suffix of “00.”) Tribal census tract codes all begin with the letter “T” and are followed by three digits and the 2-character suffix, for example T00200. Tribal census tracts codes have an implied decimal between the basic code and the suffix, and they are unique within an American Indian reservation and/or ORTL. The code can be found in the TTRACTCE field.

Tribal Census Tract Names—the tribal census tract code also acts as its name, with the suffix only appended if required. While, the TTRACTCE field contains the 6-character code format (including the suffix), the NAME field contains the tribal census tract name as displayed in Census Bureau printed reports and on mapping products. The name will consist of the first four characters (“T” followed by three digits, including any leading or trailing zeroes) and a decimal point followed by the 2-character suffix if the suffix is something other than “00.” When the suffix is only zeroes, the decimal point and suffix in the tribal tract are omitted from the name. For example, tribal census tract code “T01000” has a tribal census tract name of “T010”. The NAMELSAD field includes both the translated legal/statistical area description and the tribal tract name, as in “Tribal census tract T010”.

For more information on the TSAP, please visit:
http://www.census.gov/geo/partnerships/tsap2010_overview.html.

3.1.4.1 Tribal Census Tract National Shapefile (Current)

File Name: tl_2015_us_ttract.shp

Field	Length	Type	Description
AIANNHCE	4	String	Current American Indian/Alaska Native/Native Hawaiian area census code
TTRACTCE	6	String	Current tribal census tract code
GEOID	10	String	Tribal census tract identifier; a concatenation of the American Indian Area census code and tribal census tract code

Field	Length	Type	Description
NAME	7	String	Current tribal census tract name, including the decimal point and decimal digits if a non-zero census tract suffix exists
NAMELSAD	27	String	Current translated legal/statistical area description and the tribal census tract name
MTFCC	5	String	MAF/TIGER feature class code (G2400)
ALAND	14	Number	Current land area
AWATER	14	Number	Current water area
INTPTLAT	11	String	Current latitude of the internal point
INTPTLON	12	String	Current longitude of the internal point

3.1.5 Tribal Block Group

Tribal block group geography and attributes are available in the following shapefile:

Tribal Block Group National Shapefile (Current)

Tribal block groups are subdivisions of a tribal census tract. Tribal block groups were defined by federally recognized tribal government officials in the Census Bureau's Tribal Statistical Areas Program (TSAP) for the 2010 Census. If a tribal government declined to participate in TSAP, the Census Bureau delineated tribal block groups on the American Indian reservation and/or off-reservation trust land (ORTL). Tribal block groups are intended to generally contain between 600 and 3,000 persons or between 240 and 1,200 housing units. Many American Indian reservations and ORTLs have less than the minimum population thresholds for more than one tribal block group and in those cases one tribal block group was delineated that covers the entire American Indian reservation and/or ORTL. Unlike standard block groups, the cluster of blocks that comprises each tribal block group will not necessarily begin with the same first number of their 4-character census block number, but may contain blocks from several different standard census block groups.

A tribal block group usually covers a contiguous area but in some cases may consist of more than one discrete area. Tribal block groups nest within tribal census tracts and within individual federally recognized American Indian reservations and/or ORTLs. In some cases, an American Indian reservation and/or ORTLs might be discontinuous, so the tribal block groups are as well. In addition, tribal block group boundaries may cross standard census tract, standard block group, county, and/or state boundaries.

Tribal block groups are uniquely named within tribal tracts. Tribal block group names and codes are identical and are a single capital letter character from "A" to "K" (except for the letter "I"). There is no relationship between the tribal block group identifier and the numbering of the census blocks that form the tribal block group. A tribal block group will always be identified in conjunction with the tribal census tract within which it is contained, for example T00100A.

For more information on the TSAP, please visit:
http://www.census.gov/geo/partnerships/tsap2010_overview.html.

3.1.5.1 Tribal Block Group National Shapefile (Current)

File Name: tl_2015_us_tbg.shp

Field	Length	Type	Description
AIANNHCE	4	String	Current Census American Indian/Alaska Native/Native Hawaiian area census code
TTRACTCE	6	String	Current tribal census tract code
TBLKGPCE	1	String	Current tribal block group letter
GEOID	11	String	Tribal block group identifier; a concatenation of the Current American Indian/Alaska Native/Native Hawaiian area census code, tribal census tract code, and tribal block group letter
NAMELSAD	20	String	Current translated legal/statistical area description and the tribal block group letter
MTFCC	5	String	MAF/TIGER feature class code (G2410)
ALAND	14	Number	Current land area
AWATER	14	Number	Current water area
INTPTLAT	11	String	Current latitude of the internal point
INTPTLON	12	String	Current longitude of the internal point

3.2 Blocks (Census Block)

Block geography and attributes are available in the following shapefile:

Block State-based Shapefile (2010 Geography)

Census blocks are statistical areas bounded on all sides by visible features, such as streets, roads, streams, and railroad tracks, and by non-visible boundaries such as city, town, township, and county limits, and short line-of-sight extensions of streets and roads. Generally, census blocks are small in area; for example, a block in a city. Census blocks in suburban and rural areas may be large, irregular and bounded by a variety of features, such as roads, streams, and/or transmission line rights-of-way. In remote areas, census blocks may encompass hundreds of square miles. Census blocks cover all territory in the United States, Puerto Rico, and the Island areas. Blocks do not cross the boundaries of any entity for which the Census Bureau tabulates data. (See Figures 1 and 2).

Census Block Numbers (2010 Geography)—Census 2010 blocks are numbered uniquely within the 2010 boundaries of each state/county/census tract with a 4-character census block number. The first character of the tabulation block number identifies the block group. A block number can only be unique by using

the decennial census state, county, census tract, and block or STATEFP10 + COUNTYFP10 + TRACTCE10 + BLOCKCE10. There is no consistency in block numbers from census to census.

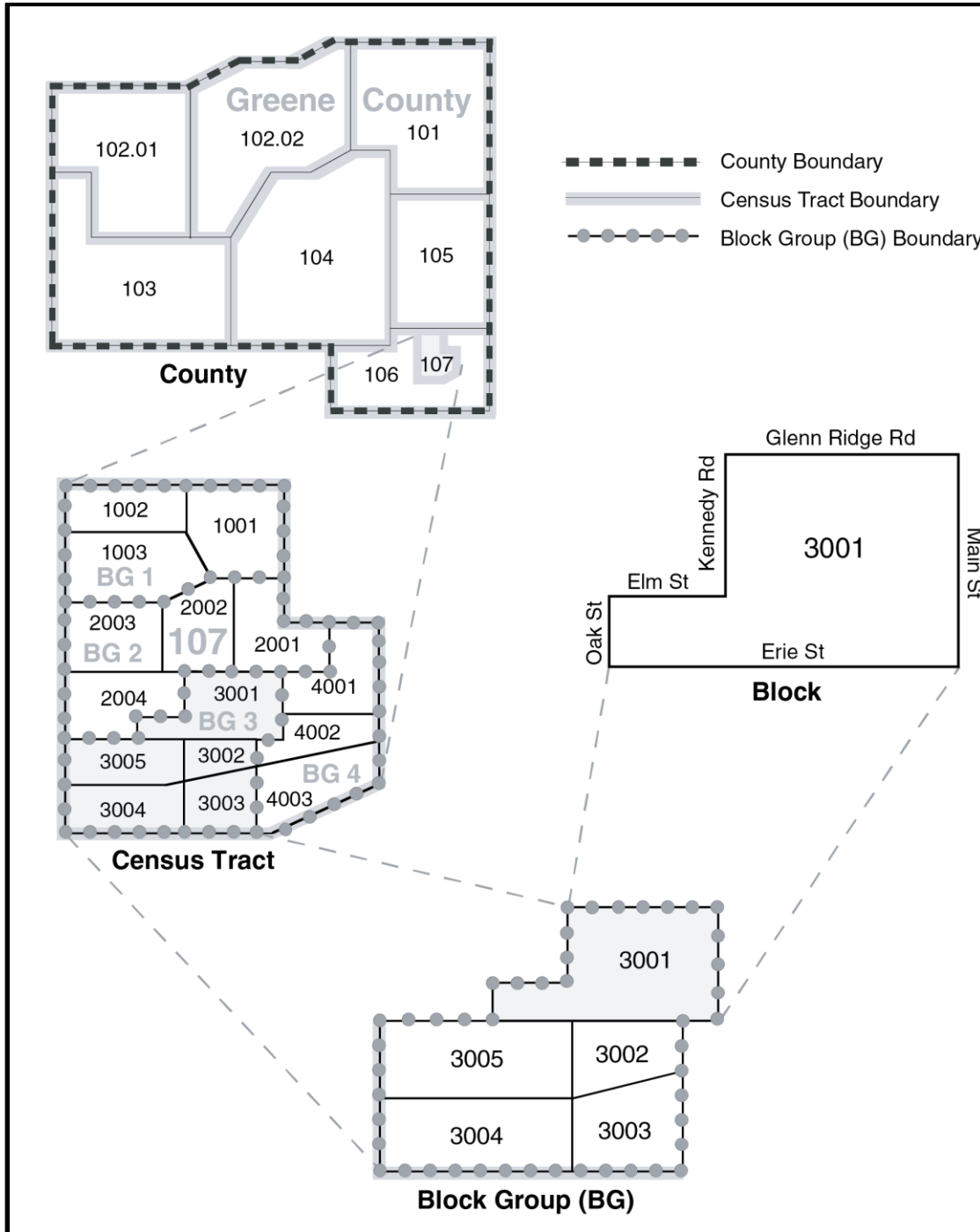

Figure 1: Geographic Relationships - Small Area Statistical Entities; County-Census Tract-Block Group-Block

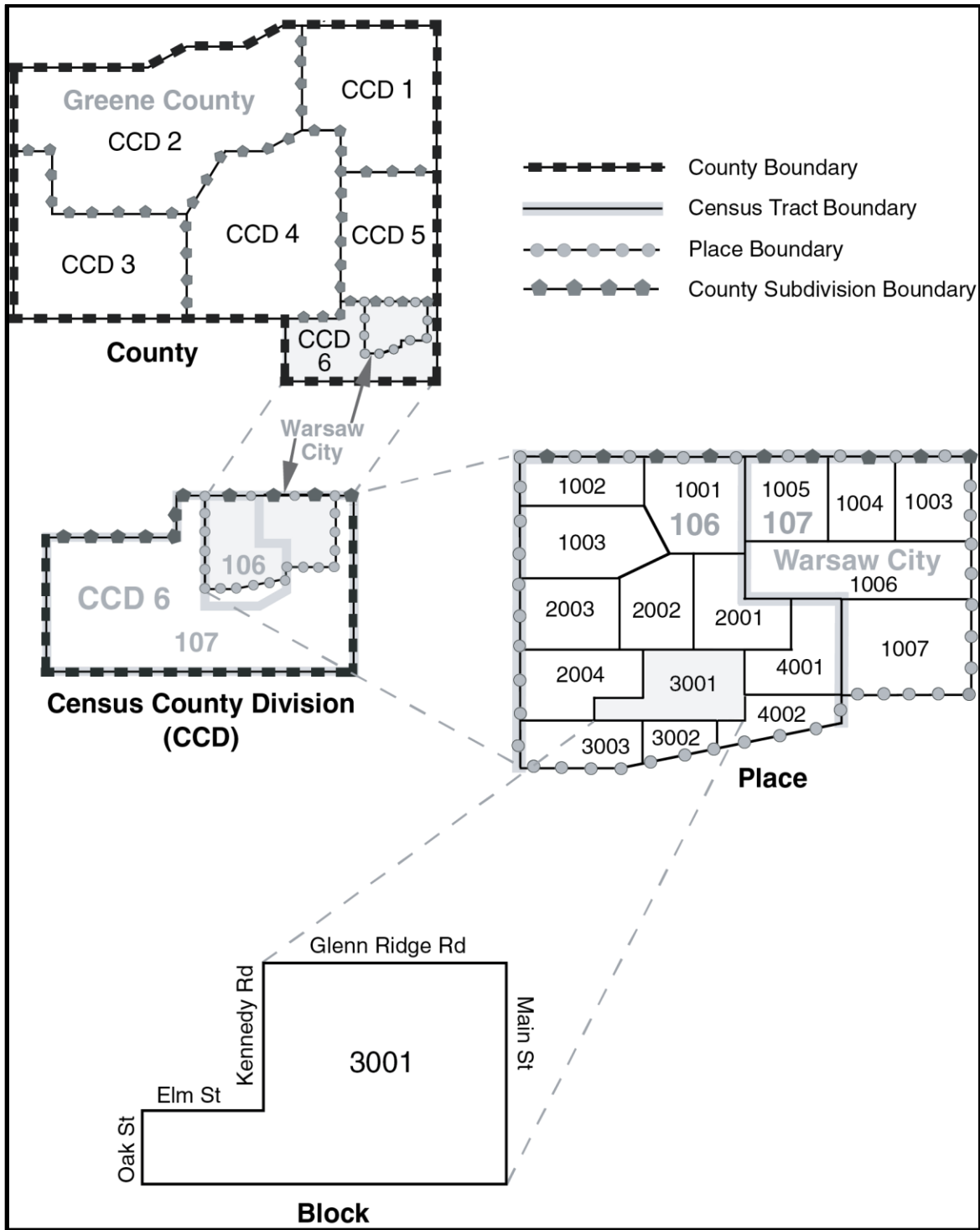

Figure 2: Geographic Relationships - Legal and Statistical Entities; County-County Subdivision-Place-Block

3.2.1 Block State-based Shapefile Record Layout (2010 Geography)

File Name: tl_2015_<state FIPS>_tabblock10.shp

Field	Length	Type	Description
STATEFP10	2	String	2010 Census state FIPS code
COUNTYFP10	3	String	2010 Census county FIPS code
TRACTCE10	6	String	2010 Census tract code
BLOCKCE10	4	String	2010 Census tabulation block number
GEOID10	15	String	Census block identifier; a concatenation of 2010 Census state FIPS code, 2010 Census county FIPS code, 2010 Census tract code, and 2010 Census block number
NAME10	10	String	2010 Census tabulation block name; a concatenation of 'Block' and the tabulation block number
MTFCC10	5	String	MAF/TIGER feature class code (G5040)
UR10	1	String	2010 Census urban/rural indicator
UACE10	5	String	2010 Census urban area code
UATYPE	1	String	2010 Census urban area type
FUNCSTAT10	1	String	2010 Census functional status
ALAND10	14	Number	2010 Census land area
AWATER10	14	Number	2010 Census water area
INTPTLAT10	11	String	2010 Census latitude of the internal point
INTPTLON10	12	String	2010 Census longitude of the internal point

3.3 Block Groups

Block group geography and attributes are available in the following shapefile:

Block Group State-based Shapefile (Current)

Standard block groups are clusters of blocks within the same census tract that have the same first digit of their 4-character census block number. For example, blocks 3001, 3002, 3003... 3999 in census tract 1210.02 belong to Block Group 3. Due to boundary and feature changes that occur throughout the decade, current block groups do not always maintain these same block number to block group relationships. For example, block 3001 might move due to a census tract boundary change but the block number will not change, even if it does not still fall in block group 3. However, the GEOID for that block,

identifying block group 3, would remain the same in the attribute information in the TIGER/Line Shapefiles because block GEOIDs are always built using the decennial geographic codes.

Block groups delineated for the 2010 Census generally contain between 600 and 3,000 people. Most block groups were delineated by local participants in the Census Bureau's Participant Statistical Areas Program (PSAP). The Census Bureau delineated block groups only where a local or tribal government declined to participate or where the Census Bureau could not identify a potential local participant.

A block group usually covers a contiguous area. Each census tract contains at least one block group and block groups are uniquely numbered within census tract. Within the standard census geographic hierarchy, block groups never cross county or census tract boundaries, but may cross the boundaries of county subdivisions, places, urban areas, voting districts, congressional districts, and American Indian, Alaska Native, and Native Hawaiian areas.

Block groups have a valid range of 0 through 9. Block groups beginning with a zero generally are in coastal and Great Lakes water and territorial seas. Rather than extending a census tract boundary into the Great Lakes or out to the 3-mile territorial sea limit, the Census Bureau delineated some census tract boundaries along the shoreline or just offshore.

For more information about the PSAP, please visit:
http://www.census.gov/geo/partnerships/psap_overview.html.

3.3.1 Block Group State-based Shapefile Record Layout (Current)

File Name: tl_2015_<state FIPS>_bg.shp

Field	Length	Type	Description
STATEFP	2	String	Current state FIPS code
COUNTYFP	3	String	Current county FIPS code
TRACTCE	6	String	Current census tract code
BLKGRPCE	1	String	Current block group number
GEOID	12	String	Census block group identifier; a concatenation of the current state FIPS code, county FIPS code, census tract code, and block group number.
NAMELSAD	13	String	Current translated legal/statistical area description and the block group number
MTFCC	5	String	MAF/TIGER feature class code (G5030)
FUNCSTAT	1	String	Current functional status
ALAND	14	Number	Current land area
AWATER	14	Number	Current water area
INTPTLAT	11	String	Current latitude of the internal point

Field	Length	Type	Description
INTPTLON	12	String	Current longitude of the internal point

3.4 Census Tracts

Census tract geography and attributes are available in the following shapefile:

Census Tract State-based Shapefile (Current)

Census tracts are small, relatively permanent statistical subdivisions of a county or equivalent entity, and are reviewed and updated by local participants prior to each decennial census as part of the Census Bureau's Participant Statistical Areas Program (PSAP). The Census Bureau updates census tracts in situations where no local participant existed or where local or tribal governments declined to participate. The primary purpose of census tracts is to provide a stable set of geographic units for the presentation of decennial census data.

Census tracts generally have a population size between 1,200 and 8,000 people with an optimum size of 4,000 people. The spatial size of census tracts varies widely depending on the density of settlement. Census tracts are delineated with the intention of being maintained over a long time so that statistical comparisons can be made from census to census. However, physical changes in street patterns caused by highway construction, new development, and so forth, may require boundary revisions. In addition, census tracts occasionally are split due to population growth or combined as a result of substantial population decline.

Census tract boundaries generally follow visible and identifiable features. They may follow legal boundaries such as minor civil division (MCD) or incorporated place boundaries in some states to allow for census tract-to-governmental unit relationships where the governmental boundaries tend to remain unchanged between censuses. State and county boundaries always are census tract boundaries in the standard census geographic hierarchy.

In a few rare instances, a census tract may consist of discontinuous areas. These discontinuous areas may occur where the census tracts are coextensive with all or parts of legal entities that are themselves discontinuous.

Census Tract Codes and Numbers—Census tract numbers have up to a 4-character basic number and may have an optional 2-character suffix; for example, 1457.02. The census tract numbers (used as names) eliminate any leading zeroes and append a suffix only if required. The 6-character numeric census tract codes, however, include leading zeroes and have an implied decimal point for the suffix. Census tract codes range from 000100 to 998999 and are unique within a county or equivalent area.

The Census Bureau assigned a census tract code of 9900 to represent census tracts delineated to cover large bodies of water. In addition, census tract codes in the 9400s represent American Indian Areas and codes in the 9800s represent special land use areas.

The Census Bureau uses suffixes to help identify census tract changes for comparison purposes. Local participants have an opportunity to review the existing census tracts before each census. If local participants split a census tract, the split parts usually retain the basic number, but receive different suffixes. In a few counties, local participants request major changes to, and renumbering of, the census

tracts. Changes to individual census tract boundaries usually do not result in census tract numbering changes.

Relationship to Other Geographic Entities—Within the standard census geographic hierarchy, census tracts never cross state or county boundaries, but may cross the boundaries of county subdivisions, places, urban areas, voting districts, congressional districts, and American Indian, Alaska Native, and Native Hawaiian areas.

Census Tract Numbers and Codes:

- 000100 to 989900—Basic number range for census tracts
- 990000 to 990099—Basic number for census tracts in water areas
- 990100 to 998900—Basic number range for census tracts

3.4.1 Census Tract State-based Shapefile Record Layout (Current)

File Name: tl_2015_<state FIPS>_tract.shp

Field	Length	Type	Description
STATEFP	2	String	Current state FIPS code
COUNTYFP	3	String	Current county FIPS code
TRACTCE	6	String	Current census tract code
GEOID	11	String	Census tract identifier; a concatenation of Current state FIPS code, county FIPS code, and census tract code
NAME	7	String	Current census tract name, this is the census tract code converted to an integer or integer plus 2-character decimal if the last two characters of the code are not both zeros.
NAMELSAD	20	String	Current translated legal/statistical area description and the census tract name
MTFCC	5	String	MAF/TIGER feature class code (G5020)
FUNCSTAT	1	String	Current functional status
ALAND	14	Number	Current land area
AWATER	14	Number	Current water area
INTPTLAT	11	String	Current latitude of the internal point
INTPTLON	12	String	Current longitude of the internal point

3.5 Congressional Districts

Congressional district geography and attributes are available in the following shapefile:

114th Congressional District National Shapefile

Congressional districts are the 435 areas from which people are elected to the U.S. House of Representatives and the five areas with nonvoting delegates from state equivalents. After the apportionment of congressional seats among the states based on decennial census population counts, each state is responsible for establishing the boundaries of the congressional districts for the purpose of electing representatives. Each congressional district is to be as equal in population to all other congressional districts in a state as practicable.

The 2015 TIGER/Line Shapefiles contain the 114th Congressional Districts. All congressional districts appearing in the 2015 TIGER/Line Shapefiles reflect the information provided to the Census Bureau by the states by May 1, 2014. The 114th Congressional District shapefile contains the areas in effect January 2015 to 2017.

The following state had changes for the 114th Congress:

- Minnesota

Each state has a minimum of one representative in the U.S. House of Representatives. The District of Columbia, Puerto Rico, American Samoa, Guam, and the U.S. Virgin Islands have a non-voting delegate in the Congress.

Congressional District Codes—Congressional districts are identified by a 2-character numeric FIPS code. Congressional districts are numbered uniquely within state. The District of Columbia, Puerto Rico and the Island areas have the code of 98, which identifies their status with respect to representation in Congress:

- 01 to 53—Congressional district codes
- 00—At large (single district for state)
- 98—Nonvoting delegate

3.5.1 114th Congressional District National Shapefile Record Layout

File Name: tl_2015_us_cd114.shp

Field	Length	Type	Description
STATEFP	2	String	Current state FIPS code
CD114FP	2	String	114th congressional district FIPS code
GEOID	4	String	114th congressional district identifier; a concatenation of current state FIPS code and the 114th congressional district FIPS code
NAMELSAD	41	String	Current name and the translated legal/statistical area description for congressional district

Field	Length	Type	Description
LSAD	2	String	Current legal/statistical area description code for congressional district
CDSSESSN	3	String	Congressional session code
MTFCC	5	String	MAF/TIGER feature class code (G5200)
FUNCSTAT	1	String	Current functional status
ALAND	14	Number	Current land area
AWATER	14	Number	Current water area
INTPTLAT	11	String	Current latitude of the internal point
INTPTLON	12	String	Current longitude of the internal point

3.6 Consolidated Cities

Consolidated city geography and attributes are available in the following shapefile:

Consolidated City State-based Shapefile (Current)

A consolidated government is a unit of local government for which the functions of an incorporated place and its county or minor civil division (MCD) have merged. This action results in both the primary incorporated place and the county or MCD continuing to exist as legal entities, even though the county or MCD performs few or no governmental functions and has few or no elected officials. When one or more other incorporated places in the county or MCD is included in the consolidated government but continues to function as separate government, the primary incorporated place is referred to as a consolidated city. The Census Bureau classifies the separately incorporated places within the consolidated city as place entities and creates a separate place (balance) record for the portion of the consolidated city not within any other place. Consolidated cities are represented in the 2015 Census TIGER/Line Shapefiles by a 5-character numeric FIPS code and an 8-character National Standard (GNIS) code.

Consolidated City (Balance) Portions refer to the areas of a consolidated city not included in another separately incorporated place. For example, Butte-Silver Bow, MT, is a consolidated city (former Butte city and Silver Bow County) that includes the separately incorporated municipality of Walkerville city. The area of the consolidated city that is not in Walkerville city is assigned to Butte-Silver Bow (balance). The name always includes the “(balance)” identifier. Balance portions of consolidated cities are included in the Place shapefiles.

3.6.1 Consolidated City Shapefile Record Layout (Current)

File Name: tl_2015_<stateFIPS>_concity.shp

Field	Length	Type	Description
-------	--------	------	-------------

Field	Length	Type	Description
STATEFP	2	String	Current state FIPS code
CONCTYFP	5	String	Current consolidated city FIPS code
CONCTYNS	8	String	Current consolidated city GNIS code
GEOID	7	String	Consolidated city identifier; a concatenation of current state FIPS code and consolidated city FIPS code
NAME	100	String	Current consolidated city name
NAMELSAD	100	String	Current name and the translated legal/statistical area description for consolidated city
LSAD	2	String	Current legal/statistical area description code for consolidated city
CLASSFP	2	String	Current FIPS class code
MTFCC	5	String	MAF/TIGER feature class code (G4120)
FUNCSTAT	1	String	Current functional status
ALAND	14	Number	Current land area
AWATER	14	Number	Current water area
INTPTLAT	11	String	Current latitude of the internal point
INTPTLON	12	String	Current longitude of the internal point

3.7 Counties and Equivalent Entities

County and equivalent entity geography and attributes are available in the following shapefile:

County and Equivalent Entity National Shapefile (Current)

Counties and equivalent entities are primary legal divisions of states. In most states, these entities are termed “counties.” In Louisiana, these divisions are known as “parishes.” In Alaska, the equivalent entities are the organized boroughs, city and boroughs, and municipalities, and for the unorganized areas, census areas. The census areas are delineated cooperatively for statistical purposes by the State of Alaska and the Census Bureau. In four states (Maryland, Missouri, Nevada, and Virginia), there are one or more incorporated places that are independent of any county organization and thus constitute primary divisions of their states. These incorporated places are known as independent cities and are treated as county equivalent entities for purposes of data presentation. The District of Columbia and Guam have no primary divisions and each area is considered a county equivalent entity for purposes of data presentation. The Census Bureau treats the following entities as equivalents of counties for purposes of data presentation: municipios in Puerto Rico, districts and islands in American Samoa, municipalities in the Commonwealth of the Northern Mariana Islands, and islands in the U.S. Virgin

Islands. Each county or statistically equivalent entity is assigned a 3-character FIPS code that is unique within a state, as well as an 8-character National Standard (GNIS) code.

The 2015 TIGER/Line Shapefiles are based on available governmental unit boundaries of the counties and equivalent entities as of January 1, 2015. Detailed information about changes in the inventory and codes for county and equivalent areas can be found at:

http://www.census.gov/geo/partnerships/bas/bas_newannex.html.

Core-based Statistical Area (CBSA) Codes – The 2015 county and equivalent entity shapefiles also contain fields with codes for combined statistical area, metropolitan or micropolitan statistical area, and metropolitan division. Counties form the building blocks for CBSAs, thus county records can be merged to form these areas without having to acquire the individual CBSA shapefiles.

3.7.1 County and Equivalent Entity National Shapefile Record Layout (Current)

File Name: tl_2015_us_county.shp

Field	Length	Type	Description
STATEFP	2	String	Current state FIPS code
COUNTYFP	3	String	Current county FIPS code
COUNTYNS	8	String	Current county GNIS code
GEOID	5	String	County identifier; a concatenation of Current state FIPS code and county FIPS code
NAME	100	String	Current county name
NAMELSAD	100	String	Current name and the translated legal/statistical area description for county
LSAD	2	String	Current legal/statistical area description code for county
CLASSFP	2	String	Current FIPS class code
MTFCC	5	String	MAF/TIGER feature class code (G4020)
CSAFP	3	String	Current combined statistical area code
CBSAFP	5	String	Current metropolitan statistical area/micropolitan statistical area code
METDIVFP	5	String	Current metropolitan division code
FUNCSTAT	1	String	Current functional status
ALAND	14	Number	Current land area
AWATER	14	Number	Current water area
INTPTLAT	11	String	Current latitude of the internal point

Field	Length	Type	Description
INTPTLON	12	String	Current longitude of the internal point

3.8 County Subdivisions

County subdivision geography and attributes are available in the following shapefile:

County Subdivision State-based Shapefile (Current)

County subdivisions are the primary divisions of counties and their equivalent entities for the reporting of decennial census data. They include census county divisions, census subareas, minor civil divisions, and unorganized territories. They may represent legal or statistical entities. The 2015 TIGER/Line Shapefiles contain a 5-character FIPS code field for county subdivisions and an 8-character National Standards (GNIS) code.

Legal Entity Definition

Minor Civil Divisions (MCDs) are the primary governmental or administrative divisions of a county in many states. MCDs represent many different kinds of legal entities with a wide variety of governmental and/or administrative functions. MCDs include areas designated as American Indian reservations, assessment districts, barrios, barrios-pueblo, boroughs, census subdistricts, charter townships, commissioner districts, counties, election districts, election precincts, gores, grants, locations, magisterial districts, parish governing authority districts, plantations, precincts, purchases, supervisor's districts, towns, and townships. The Census Bureau recognizes MCDs in 29 states, Puerto Rico, and the Island areas. The District of Columbia has no primary divisions and the incorporated place of Washington is treated as an equivalent to an MCD for statistical purposes. In 23 states, all or some incorporated places are not part of any MCD. These places also serve as primary legal county subdivisions and have a FIPS MCD code that is the same as the FIPS place code. The GNIS codes also match for those entities. In other states, incorporated places are part of the MCDs in which they are located or the pattern is mixed—some incorporated places are independent of MCDs and others are included within one or more MCDs. The MCDs in 12 states (Connecticut, Maine, Massachusetts, Michigan, Minnesota, New Hampshire, New Jersey, New York, Pennsylvania, Rhode Island, Vermont, and Wisconsin) also serve as general-purpose local governments that generally can perform the same governmental functions as incorporated places. The Census Bureau presents data for these MCDs in all data products for which place data are provided.

In New York and Maine, American Indian reservations (AIRs) exist outside the jurisdiction of any town (MCD) and thus serve as the equivalent of MCDs for purposes of data presentation.

Statistical Entity Definitions

Census County Divisions (CCDs) are areas delineated by the Census Bureau in cooperation with state and local officials for statistical purposes. CCDs are not governmental units and have no legal functions. CCD boundaries usually follow visible features and, in most cases, coincide with census tract boundaries. The name of each CCD is based on a place, county, or well-known local name that identifies its location. CCDs exist where:

- There are no legally established minor civil divisions (MCDs)
- The legally established MCDs do not have governmental or administrative purposes
- The boundaries of the MCDs change frequently

- The MCDs are not generally known to the public

CCDs have been established for the following 20 states:

Alabama	Arizona	California	Colorado	Delaware	Florida
Georgia	Hawaii	Idaho	Kentucky	Montana	Nevada
New Mexico	Oklahoma	Oregon	South Carolina	Texas	Utah
Washington	Wyoming				

Census Subareas are statistical subdivisions of boroughs, city and boroughs, municipalities, and census areas, the latter of which are the statistical equivalent entities for counties in Alaska. The state of Alaska and the Census Bureau cooperatively delineate the census subareas to serve as the statistical equivalents of MCDs.

Unorganized Territories (UTs) have been defined by the Census Bureau in 9 minor civil division (MCD) states and American Samoa where portions of counties or equivalent entities are not included in any legally established MCD or incorporated place. The Census Bureau recognizes such separate pieces of territory as one or more separate county subdivisions for census purposes. It assigns each unorganized territory a descriptive name, followed by the designation “unorganized territory” and county subdivision FIPS and GNIS codes. Unorganized territories are recognized in the following states and equivalent areas:

Arkansas	Indiana	Iowa	Maine	Minnesota	New York
North Carolina	North Dakota	South Dakota			

Undefined County Subdivisions—in water bodies, primarily Great Lakes waters and territorial sea, legal county subdivisions do not extend to cover the entire county. For these areas, the Census Bureau created a county subdivision with a FIPS code of 00000 and GNIS code of 00000000 named “county subdivision not defined.” The following states and equivalent areas have these county subdivisions:

Connecticut	Illinois	Indiana	Maine	Massachusetts	Michigan
Minnesota	New Hampshire	New Jersey	New York	Ohio	Pennsylvania
Rhode Island	Wisconsin	Puerto Rico			

New England City and Town Area (NECTA) Codes — The 2015 county subdivision shapefiles also contain fields with codes for Combined New England city and town area, New England city and town area, and New England city and town area division. The NECTAs are delineated by whole county subdivision in New England only, thus county subdivision records can be merged to form these areas without having to acquire the individual NECTA shapefiles.

3.8.1 County Subdivision State-based Shapefile Record Layout (Current)

File Name: tl_2015_<stateFIPS>_cousub.shp

Field	Length	Type	Description
STATEFP	2	String	Current state FIPS code
COUNTYFP	3	String	Current county FIPS code
COUSUBFP	5	String	Current county subdivision FIPS code

Field	Length	Type	Description
COUSUBNS	8	String	Current county subdivision GNIS code
GEOID	10	String	County subdivision identifier; a concatenation of current state FIPS code, county FIPS code, and county subdivision FIPS code.
NAME	100	String	Current county subdivision name
NAMELSAD	100	String	Current name and the translated legal/statistical area description code for county subdivision
LSAD	2	String	Current legal/statistical area description code for county subdivision
CLASSFP	2	String	Current FIPS class code
MTFCC	5	String	MAF/TIGER feature class code (G4040)
CNECTAFP	3	String	Current combined New England city and town area code
NECTAFP	5	String	Current New England city and town area code
NCTADVFP	5	String	Current New England city and town area division code
FUNCSTAT	1	String	Current functional status
ALAND	14	Number	Current land area
AWATER	14	Number	Current water area
INTPTLAT	11	String	Current latitude of the internal point
INTPTLON	12	String	Current longitude of the internal point

3.9 Estates

Estate features and attributes are available in the United States Virgin Islands in the following shapefile:

Estate State-based Shapefile (Current)

Estates are subdivisions of the three major islands in the United States Virgin Islands (USVI). The estates have legally defined boundaries and are generally smaller in area than the Census Subdistricts (county subdivisions), but do not necessarily nest within these districts. The boundaries of the estates are primarily those of the former agricultural plantations that existed at the time Denmark transferred the islands to the United States in 1917. The names and boundaries of the estates are in common usage by residents and in government administration. The boundaries of the estates are as of January 1, 2010 and were provided to the Census Bureau by the USVI Office of the Lieutenant Governor. Estates can be found in the SubMinor Civil Division (submcd) shapefile for the 2010 and the 2011 TIGER/Line products.

3.9.1 Estate Shapefile (U.S. Virgin Islands Only) Record Layout (Current)

File Name: tl_2015_78_estate.shp

Field	Length	Type	Description
STATEFP	2	String	Current state FIPS code
COUNTYFP	3	String	Current county FIPS code
ESTATEFP	5	String	Current estate FIPS code
ESTATENS	8	String	Current estate GNIS code
GEOID	10	String	Estate identifier; a concatenation of current state FIPS code, county FIPS code, and estate FIPS code
NAME	100	String	Current estate name
NAMELSAD	100	String	Current name and the translated legal/statistical area description for estate
LSAD	2	String	Current legal/statistical area description code for estate
CLASSFP	2	String	Current FIPS class code
MTFCC	5	String	MAF/TIGER feature class code (G4050)
FUNCSTAT	1	String	Current functional status
ALAND	14	Number	Current land area
AWATER	14	Number	Current water area
INTPTLAT	11	String	Current latitude of the internal point
INTPTLON	12	String	Current longitude of the internal point

3.10 Hydrography (Area and Linear)

Hydrography features and attributes are available in the following shapefiles:

- Area Hydrography County-based Shapefile
- Linear Hydrography County-based Shapefile

The area hydrography shapefile contains the geometry and attributes of both perennial and intermittent area hydrography features, including ponds, lakes, oceans, swamps, glaciers, and the area covered by large streams represented as double-line drainage. Single-line drainage water features can be found in the all lines shapefile and linear hydrography shapefile.

The linear hydrography shapefile contains all linear features with "H" (Hydrography) type MTFCCs in the MAF/TIGER database by county. The shapefiles are provided at a county geographic extent and in linear

elemental feature geometry. The linear hydrography shapefile includes streams/rivers, braided streams, canals, ditches, artificial paths, and aqueducts. A linear hydrography feature may include edges with both perennial and intermittent persistence.

Single-line drainage water features include artificial path features that run through double-line drainage features such as rivers and streams and serve as a linear representation of these features. The artificial path features may correspond to those in the USGS National Hydrographic Dataset (NHD). However, in many cases the features do not match NHD equivalent feature and will not carry the NHD metadata codes.

Shorelines for area hydrography can be found in the all lines shapefiles with MTFCC set to either “P0002” (shoreline of perennial water feature) or “P0003” (shoreline of intermittent water feature).

3.10.1 Area Hydrography County-based Shapefile Record Layout

File Name: tl_2015_<state-countyFIPS>_areawater.shp

Field	Length	Type	Description
ANSICODE	8	String	Official code for the water body for use by federal agencies for data transfer and dissemination, if applicable
HYDROID	22	String	Area hydrography identifier
FULLNAME	100	String	Concatenation of expanded text for prefix qualifier, prefix direction, prefix type, base name, suffix type, suffix direction, and suffix qualifier (as available) with a space between each expanded text field
MTFCC	5	String	MAF/TIGER feature class code
ALAND	14	Number	Land area
AWATER	14	Number	Water area
INTPTLAT	11	String	Latitude of the internal point
INTPTLON	12	String	Longitude of the internal point

3.10.2 Linear Hydrography County-based Shapefile Record Layout

File Name: tl_2015_<state-countyFIPS>_linearwater.shp

Field	Length	Type	Description
ANSICODE	8	String	Official code for use by federal agencies for data transfer and dissemination, if applicable
LINEARID	22	String	Linear hydrography identifier

Field	Length	Type	Description
FULLNAME	100	String	Concatenation of expanded text for prefix qualifier, prefix direction, prefix type, base name, suffix type, suffix direction, and suffix qualifier (as available) with a space between each expanded text field
ARTPATH	1	String	Artificial path flag
MTFCC	5	String	MAF/TIGER feature class code

3.11 Landmarks (Area and Point)

Landmark features and attributes are available in the following shapefiles:

- Area Landmark State-based Shapefile
- Point Landmark State-based Shapefile

The Census Bureau includes landmarks in the MAF/TIGER database (MTDB) for locating special features and to help enumerators during field operations. Some of the more common landmark types include area landmarks such as airports, cemeteries, parks, and educational facilities and point landmarks such as schools and churches.

The Census Bureau adds landmark features to the database on an as-needed basis and makes no attempt to ensure that all instances of a particular feature were included. The absence of a landmark such as a hospital or prison does not mean that the living quarters associated with that landmark were excluded from the 2010 Census enumeration. The landmarks were not used as the basis for building or maintaining the address list used to conduct the 2010 Census.

Area landmark and area water features can overlap; for example, a park or other special land-use feature may include a lake or pond. In this case, the polygon covered by the lake or pond belongs to a water feature and a park landmark feature. Other kinds of landmarks can overlap as well. Area landmarks can contain point landmarks, but these features are not linked in the TIGER/Line Shapefiles.

Landmarks may be identified by a MAF/TIGER feature class code only and may not have a name. Each landmark has a unique area landmark identifier (AREAID) or point landmark identifier (POINTID) value.

3.11.1 Area Landmark State-based Shapefile Record Layout

File Name: tl_2015_<stateFIPS>_arealm.shp

Field	Length	Type	Description
STATEFP	2	String	State FIPS code
ANSICODE	8	String	Official code for the landmark for use by federal agencies for data transfer and dissemination
AREAID	22	String	Area landmark identifier

Field	Length	Type	Description
FULLNAME	100	String	Concatenation of expanded text for prefix qualifier, prefix direction, prefix type, base name, suffix type, suffix direction, and suffix qualifier with a space between each expanded text field
MTFCC	5	String	MAF/TIGER feature class code
ALAND	14	Number	Land area
AWATER	14	Number	Water area
INTPTLAT	11	String	Latitude of the internal point
INTPTLON	12	String	Longitude of the internal point
PARTFLG	1	String	Part Flag identifying if all or part of the entity is within the file

3.11.2 Point Landmark State-based Shapefile Record Layout

File Name: tl_2015_<stateFIPS>_pointlm.shp

Field	Length	Type	Description
STATEFP	2	String	State FIPS code
ANSICODE	8	String	Official code for the point landmark for use by federal agencies for data transfer and dissemination, if applicable
POINTID	22	String	Point landmark identifier
FULLNAME	100	String	Concatenation of expanded text for prefix type, base name, and suffix type with a space between each expanded text field
MTFCC	5	String	MAF/TIGER feature class code

3.12 Linear Features

Linear elemental features are the spatial representation of 1-dimensional roads, hydrography, railroads, and other miscellaneous features in the MAF/TIGER database. A linear elemental feature can span one edge or multiple connecting edges that share a common name and feature classification (MTFCC).

More than one linear elemental feature can share the same edge or group of connected edges. For example, an edge may be associated with a linear feature called Oak Street. This same edge may be one of several edges also associated with another linear feature called State Highway 57. The edge in question has two names: Oak Street and State Highway 57. One of these names will be designated as

primary and the others as alternate names. Usually the common street name (Oak Street) will be primary.

The MAF/TIGER database breaks/ends linear elemental features when the feature name changes. All spelling differences are represented by a new feature. Features will also break at county boundaries, changes in primary/alternate designation, MTFCC, and gaps in the geometry.

Linear features and attributes are available in the following shapefiles.

3.12.1 All Lines

Each all lines shapefile describes the universe of edges that either bound or are included within a county or equivalent entity. The shapefile describes the geometry of each edge along with descriptive attributes and unique identification numbers. These identification numbers provide the means for linking the edges to alternate features such as their names, address ranges, and adjacent faces.

The all lines features and attributes are in the following shapefile:

All Lines County-based Shapefile

The all lines shapefile contains visible linear feature edges such as roads, railroads, and hydrography, as well as non-feature edges and non-visible boundaries. Additional attribute data associated with the edges are available in relationship files that users must download separately.

The all lines shapefile contains the geometry and attributes of each topological primitive edge. Each edge has a unique TLID (permanent edge identifier) value. The edge's left and right faces can be identified by the TFIDL (permanent face identifier on the left side of the edge) and TFIDR (permanent face identifier on the right side of the edge) attributes which link to the TFID attribute in the Topological Faces shapefile.

The left and right side of an edge is determined by the order of the points that form the edge. An edge is oriented from the start node to the end node. If one is standing on an edge at the start node facing the end node, data listed in the fields carrying a right qualifier would be found to the right of the edge. Data users can employ GIS software to plot the edges as directional vectors with arrows showing the orientation of edges.

In the MAF/TIGER database, edges may represent several types of features. The series of indicator flags (HYDROFLG, ROADFLG, RAILFLG, and OLFFLG) indicate the classes of features that share the edge. For example, a road may have embedded railroad tracks; the corresponding edge will have both the ROADFLG (road feature indicator) and RAILFLG (rail feature indicator) set. Generally, certain feature types appear together on the same edge:

Road and Rail—roads with adjacent tracks, tracks embedded in roadways or tracks located in the median
Rail and Other Linear Feature—rail features located on dams and levees
Road and Other Linear Feature—road features located on dams and levees

The MAF/TIGER feature class code (MTFCC) identifies the specific code for the primary feature on the edge. For edges that represent roads in combination with other features, the MTFCC in the all lines shapefile will reflect the road feature.

3.12.1.1 All Lines County-based Shapefile Record Layout

File Name: tl_2015_<state-county>_edges.shp

Field	Length	Type	Description
STATEFP	2	String	State FIPS code
COUNTYFP	3	String	County FIPS code
TLID	10	Integer	Permanent edge ID
TFIDL	10	Integer	Permanent face ID on the left of the edge
TFIDR	10	Integer	Permanent face ID on the right of the edge
MTFCC	5	String	MAF/TIGER feature class code of the primary feature for the edge
FULLNAME	100	String	Concatenation of expanded text for prefix qualifier, prefix direction, prefix type, base name, suffix type, suffix direction, and suffix qualifier with a space between each expanded text field (as available)
SMID	22	String	Spatial metadata identifier
LFROMADD	12	String	From house number associated with the most inclusive address range on the left side of the edge
LTOADD	12	String	To house number associated with the most inclusive address range on the left side of the edge
RFROMADD	12	String	From house number associated with the most inclusive address range on the right side of the edge
RTOADD	12	String	To house number associated with the most inclusive address range on the right side of the edge
ZIPL	5	String	ZIP code associated with the most inclusive address range on the left side
ZIPR	5	String	ZIP code associated with the most inclusive address range on the right side
FEATCAT	1	String	General feature classification category
HYDROFLG	1	String	Hydrography feature indicator
RAILFLG	1	String	Rail feature indicator
ROADFLG	1	String	Road feature indicator
OLFFLG	1	String	Other linear feature indicator
PASSFLG	1	String	Special passage flag

Field	Length	Type	Description
DIVROAD	1	String	Divided road flag
EXTTYP	1	String	Extension type
TTYP	1	String	Track type
DECKEDROAD	1	String	Decked road indicator
ARTPATH	1	String	Artificial path indicator
PERSIST	1	String	Hydrographic persistence flag
GCSEFLG	1	String	Short lines flag for geographic corridors
OFFSETL	1	String	Left offset flag
OFFSETR	1	String	Right offset flag
TNIDF	10	Integer	From TIGER node identifier
TNIDT	10	Integer	To TIGER node identifier

3.12.2 Coastline

The coastline boundary is available in the following shapefile:

Coastline National Shapefile

The coastline shapefile includes all features within the MTDB class "Coastline," distinguished by the MAF/TIGER feature classification code (MTFCC) L4150. The coastline included in this shapefile was delineated by the Census Bureau in the MAF/TIGER database based on water measurement class for display of statistical information only; its depiction and designation for statistical purposes does not constitute a determination of jurisdictional authority or rights of ownership or entitlement and it is not a legal land description. The name assigned to each coastline feature is a short form of the name of the large body of water bordered by this coastline feature.

3.12.2.1 Coastline National Shapefile Record Layout

File Name: tl_2015_us_coastline.shp

Field	Length	Type	Description
NAME	100	String	Coastline Name
MTFCC	5	String	MAF/TIGER Feature Class Code of the primary feature for the edge

3.12.3 Roads

Linear road features and attributes are available in the following shapefiles:

- Primary Roads National Shapefile
- Primary and Secondary Roads State-based Shapefile
- All Roads County-based Shapefile

Primary roads are generally divided, limited-access highways within the Federal interstate highway system or under state management. These highways are distinguished by the presence of interchanges and are accessible by ramps and may include some toll highways. The Primary Roads shapefile contains all linear street features with a MTFCC of "S1100" in the MAF/TIGER database. The shapefiles are provided at a national geographic extent and in linear elemental feature geometry.

The primary and secondary roads shapefile contains all linear street features with MTFCCs of "S1100" or "S1200" in the MAF/TIGER database. The shapefiles are provided at a state geographic extent and in linear elemental feature geometry. Secondary roads are main arteries, usually in the U.S. highway, state highway, or county highway system. These roads have one or more lanes of traffic in each direction, may or may not be divided, and usually have at-grade intersections with many other roads and driveways. They often have both a local name and a route number.

The content of the all roads shapefile includes primary roads, secondary roads, local neighborhood roads, rural roads, city streets, vehicular trails (4WD), ramps, service drives, walkways, stairways, alleys, and private roads. The all roads shapefile contains all linear street features with "S" (Street) type MTFCCs in the MAF/TIGER database. The shapefiles are provided at a county geographic extent and in linear elemental feature geometry.

The Census Bureau works continuously to improve the accuracy of the features in the MAF/TIGER database, including a recent focus on highway review. However, some street features may have a misclassified MTFCC. This means that there could be gaps in features in the primary roads or the primary and secondary roads shapefiles, if a segment of the feature was misclassified as an S1400,(a local neighborhood road, rural road, or city street) instead of an S1100 or S1200.

Note that the LINEARID can be used to link the linear features back to the Featnames table and from there the TLID can relate the feature back to the edges shapefile.

3.12.3.1 Primary Roads National Shapefile Record Layout

File Name: tl_2015_us_primaryroads.shp

Field	Length	Type	Description
LINEARID	22	String	Linear feature identifier
FULLNAME	100	String	Concatenation of expanded text for prefix qualifier, prefix direction, prefix type, base name, suffix type, suffix direction, and suffix qualifier (as available) with a space between each expanded text field; display name.
RTTYP	1	String	Route type code
MTFCC	5	String	MAF/TIGER feature class code

3.12.3.2 Primary and Secondary Roads State-based Shapefile Record Layout

File Name: tl_2015_<stateFIPS>_prisecroads.shp

Field	Length	Type	Description
LINEARID	22	String	Linear feature identifier
FULLNAME	100	String	Concatenation of expanded text for prefix qualifier, prefix direction, prefix type, base name, suffix type, suffix direction, and suffix qualifier (as available) with a space between each expanded text field
RTTYP	1	String	Route type code
MTFCC	5	String	MAF/TIGER feature class code

3.12.3.3 All Roads County-based Shapefile Record Layout

File Name: tl_2015_<state-countyFIPS>_roads.shp

Field	Length	Type	Description
LINEARID	22	String	Linear feature identifier
FULLNAME	100	String	Concatenation of expanded text for prefix qualifier, prefix direction, prefix type, base name, suffix type, suffix direction, and suffix qualifier (as available) with a space between each expanded text field
RTTYP	1	String	Route type code
MTFCC	5	String	MAF/TIGER feature class code

3.12.4 Address Ranges

Linear address range features and attributes are available in the following layer:

Address Range Feature County-based Shapefile

The address range feature shapefile contains the geospatial edge geometry and attributes of all unsuppressed address ranges for a county or county equivalent area. The term "address range" refers to the collection of all possible structure house numbers, from the first structure house number to the last structure house number of a specified parity along an edge side relative to the direction in which the edge is coded. All of the TIGER/Line address range files contain potential address ranges, not individual addresses. Potential ranges include the full range of possible structure numbers even though the actual structures may not exist. Single-address address ranges are suppressed to maintain the confidentiality of the addresses they describe.

The address range feature shapefile contains all of the address range to street name relationships in the address range feature name relationship file. The address range feature shapefile also contains all possible relationships between the address range relationship table and the all lines shapefile. Including all of this data results in better geocoding match rates compared with using the all lines shapefile for geocoding. The all lines shapefile only contains the most inclusive address range associated with each side of a street edge and the primary street name assigned to the edge.

3.12.4.1 Address Range Feature County-based Shapefile Record Layout

File Name: tl_2015_<state-countyFIPS>_addrfeat.shp

Field	Length	Type	Description
TLID	10	Integer	permanent edge ID
TFIDL	10	Integer	Permanent face ID on the left of the edge
TFIDR	10	Integer	Permanent face ID on the right of the edge
ARIDL	22	String	Left side Address range identifier
ARIDR	22	String	Right side Address range identifier
LINEARID	22	String	Linear feature identifier
FULLNAME	100	String	Concatenation of expanded text for prefix qualifier, prefix direction, prefix type, base name, suffix type, suffix direction, and suffix qualifier (as available) with a space between each expanded text field
LFROMHN	12	String	From House Number associated with the address range on the left side of the edge; SIDE=L
LTOHN	12	String	To House Number associated with the address range on the left side of the edge; SIDE=L
RFROMHN	12	String	From House Number associated with the address range on the right side of the edge; SIDE=R
RTOHN	12	String	To House Number associated with the address range on the right side of the edge; SIDE=R
ZIPL	5	String	ZIP code associated with the left address range
ZIPR	5	String	ZIP code associated with the right address range
EDGE_MTFCC	5	String	Primary MAF/TIGER feature class code of related edge record
ROAD_MTFCC	5	String	MAF/TIGER feature class code of related linear feature record

Field	Length	Type	Description
PARITYL	1	String	Left side Address Range Parity
PARITYR	1	String	Right side Address Range Parity
PLUS4L	4	String	Left side ZIP+4 Code
PLUS4R	4	String	Right side ZIP+4 Code
LFROMTYP	1	String	Left side From address range end type. This field will only be populated if the value is 'I' and the address range is an imputed value calculated by the Census Bureau at a split point. If the value is anything other than 'I', the field shall be left blank.
LTOTYP	1	String	Left side To address range end type. This field will only be populated if the value is 'I' and the address range is an imputed value calculated by the Census Bureau at a split point. If the value is anything other than 'I', the field shall be left blank.
RFROMTYP	1	String	Right side From address range end type. This field will only be populated if the value is 'I' and the address range is an imputed value calculated by the Census Bureau at a split point. If the value is anything other than 'I', the field shall be left blank.
RTOTYP	1	String	Right side To address range end type. This field will only be populated if the value is 'I' and the address range is an imputed value calculated by the Census Bureau at a split point. If the value is anything other than 'I', the field shall be left blank.
OFFSETL	1	String	Flag to designate if left side address range is on offset edge
OFFSETR	1	String	Flag to designate if right side address range is on offset edge

3.12.5 Railroads

Linear railroad features and attributes are available in the following layer:

Railroads National Shapefile

The railroad shapefile includes spur lines and rail yards, mass transit rail lines such as carlines, streetcar track, monorail or other mass transit rail, and special purpose rail lines such as cog rail lines, incline rail lines, and trams. The railroad shapefile contains all linear rail features with “R” (Rail) type MTFCCs in the MAF/TIGER database. The shapefiles are provided at a national geographic extent and in a linear elemental feature geometry.

3.12.5.1 Railroads National Shapefile Record Layout

File Name: tl_2015_us_rails.shp

Field	Length	Type	Description
LINEARID	22	String	Linear feature identifier
FULLNAME	100	String	Concatenation of expanded text for prefix qualifier, prefix direction, prefix type, base name, suffix type, suffix direction, and suffix qualifier (as available) with a space between each expanded text field
MTFCC	5	String	MAF/TIGER feature class code

3.13 Metropolitan and Micropolitan Statistical Areas and Related Statistical Areas

Metropolitan and micropolitan statistical area and related statistical area geography and attributes are available in the following shapefiles:

- Combined New England City and Town Area (CNECTA) National Shapefile (Current)
- Combined Statistical Area (CSA) National Shapefile (Current)
- Metropolitan Division National Shapefile (Current)
- Core Based Statistical Areas (CBSAs) National Shapefile (Metropolitan and Micropolitan Statistical Areas) (Current)
- New England City and Town Area (NECTA) National Shapefile (Current)
- New England City and Town Area (NECTA) Division National Shapefile (Current)

On February 28, 2013, the U.S. Office of Management and Budget (OMB) announced the definition of metropolitan statistical areas and micropolitan statistical areas based on the official standards that were published in the Federal Register on June 28, 2010. These standards were developed by the interagency Metropolitan Area Standards Review Committee to provide a nationally consistent set of geographic entities for the United States and Puerto Rico. No metropolitan or micropolitan areas are defined in the Island areas.

The concept of a metropolitan or micropolitan statistical area defines a core area containing a substantial population nucleus, together with adjacent communities having a high degree of economic and social integration with that core. The term "core based statistical area" (CBSA) became effective in 2000 and refers collectively to metropolitan statistical areas and micropolitan statistical areas.

Each metropolitan statistical area must have at least one urbanized area of 50,000 or more inhabitants. Each micropolitan statistical area must have at least one urban cluster of at least 10,000 but less than 50,000 inhabitants. The categorization of CBSAs as either a metropolitan statistical area or a micropolitan statistical area is based on the population in the most populous (or dominant) core, not the total CBSA population or the total population of all (multiple) cores within the CBSA.

Counties or equivalent entities form the building blocks for metropolitan and micropolitan statistical areas. Under the standards, the counties or equivalent entities in which at least 50 percent of the population resides within urban areas of 10,000 or more population, or that contain at least 5,000 people residing within a single urban area of 10,000 or more population, are identified as a central counties. Additional

outlying counties are included in the CBSA if they meet specified requirements of commuting to or from the central counties.

In New England (Connecticut, Maine, Massachusetts, New Hampshire, Rhode Island, and Vermont), the OMB has defined an alternative county subdivision (generally city and town) based definition of CBSAs known as New England city and town areas (NECTAs). NECTAs are defined using the same criteria as metropolitan and micropolitan statistical areas and are identified as either metropolitan or micropolitan, based, respectively, on the presence of either an urbanized area of 50,000 or more inhabitants or an urban cluster of at least 10,000 and less than 50,000 inhabitants.

Combined Statistical Areas (CSAs) consist of two or more adjacent CBSAs that have significant employment interchanges. The CBSAs that combine to create a CSA retain separate identities within the larger CSAs. Because CSAs represent groupings of metropolitan and micropolitan statistical areas, they should not be ranked or compared with individual metropolitan and micropolitan statistical areas.

Combined New England City and Town Areas (CNECTAs) consist of two or more adjacent NECTAs that have significant employment interchanges. The NECTAs that combine to create a CNECTA retain separate identities within the larger combined statistical areas. Because CNECTAs represent groupings of NECTAs they should not be ranked or compared with individual NECTAs.

Metropolitan Divisions are created when a metropolitan statistical area containing a single core with a population of at least 2.5 million is subdivided to form smaller groupings of counties or equivalent entities. Not all metropolitan statistical areas with urbanized areas of this size will contain metropolitan divisions. A metropolitan division consists of one or more main counties that represent an employment center or centers, plus adjacent counties associated with the main county or counties through commuting ties. Because metropolitan divisions represent subdivisions of larger metropolitan statistical areas, it is not appropriate to rank or compare metropolitan divisions with metropolitan and micropolitan statistical areas. It would be appropriate to rank and compare metropolitan divisions.

New England City and Town Area (NECTA) Divisions are created when a NECTA containing a single core with a population of at least 2.5 million is subdivided to form smaller groupings of cities and towns. A NECTA division consists of a main city or town that represents an employment center, plus adjacent cities and towns associated with the main city or town through commuting ties. Each NECTA division must contain a total population of 100,000 or more. Because NECTA divisions represent subdivisions of larger NECTAs, it is not appropriate to rank or compare NECTA divisions with NECTAs. It would be appropriate to rank and compare NECTA divisions.

OMB designates one or more principal cities within each metropolitan statistical area, micropolitan statistical area, and NECTA. Principal cities can be either incorporated places or census designated places (CDPs). In addition to identifying the more significant places in each metropolitan and micropolitan statistical area or NECTA in terms of population and employment, principal cities are also used in titling metropolitan and micropolitan statistical areas, metropolitan divisions, CSAs, NECTAs, NECTA divisions, and combined NECTAs. A principal city may be only a part of a place if a portion of that place is outside of the metropolitan statistical area, micropolitan statistical area, or NECTA.

Core Based Statistical Area Codes—the metropolitan statistical areas, micropolitan statistical areas, NECTAs, metropolitan divisions, and NECTA divisions are identified using a 5-character code. The codes for metropolitan and micropolitan statistical areas and metropolitan divisions are assigned in alphabetical order by area title and fall within the 10000 to 59999 range. Metropolitan divisions are distinguished by a code ending in "4". NECTA and NECTA division codes fall within the 70000 to 79999

range and are assigned in alphabetical order by area title. NECTA divisions are distinguished by a code ending in "4". The combined statistical areas and combined NECTAs are identified using a 3-character code. Combined statistical area codes fall within the 100 to 599 range. Combined NECTA codes fall within the 700 to 799 range. Since CBSA codes are defined nationally, no additional codes are required to provide a unique entity identifier. Since lower level divisions nest within CBSA and CBSAs nest within combined areas, the higher level codes exist in the record layouts for the subordinate entity types.

The metropolitan and micropolitan statistical area and related statistical area boundaries, names, and codes appearing in the 2015 TIGER/Line Shapefiles are those defined as of February 2013 by the OMB. For more information, please visit:

<http://www.census.gov/population/metro/>.

3.13.1 Combined New England City and Town Area (CNECTA) National Shapefile Record Layout (Current)

File Name: tl_2015_us_cnecta.shp

Field	Length	Type	Description
CNECTAFP	3	String	Current combined New England city and town area code
GEOID	3	String	Current New England city and town area identifier; combined New England city and town area code
NAME	100	String	Current combined New England city and town area name
NAMELSAD	100	String	Current name and the translated legal/statistical area description for combined New England city and town area
LSAD	2	String	Current legal/statistical area description code for combined New England city and town area
MTFCC	5	String	MAF/TIGER feature class code (G3200)
ALAND	14	Number	Current land area
AWATER	14	Number	Current water area
INTPTLAT	11	String	Current latitude of the internal point
INTPTLON	12	String	Current longitude of the internal point

3.13.2 Combined Statistical Area (CSA) National Shapefile Record Layout (Current)

File Name: tl_2015_us_csa.shp

Field	Length	Type	Description
--------------	---------------	-------------	--------------------

Field	Length	Type	Description
CSAFP	3	String	Current combined statistical area code
GEOID	3	String	Combined statistical area identifier, combined statistical area code
NAME	100	String	Current combined statistical area name
NAMELSAD	100	String	Current name and the translated legal/statistical area description for combined statistical area
LSAD	2	String	Current legal/statistical area description code for combined statistical area
MTFCC	5	String	MAF/TIGER feature class code (G3100)
ALAND	14	Number	Current land area
AWATER	14	Number	Current water area
INTPTLAT	11	String	Current latitude of the internal point
INTPTLON	12	String	Current longitude of the internal point

3.13.3 Metropolitan Division National Shapefile Record Layout (Current)

File Name: tl_2015_us_metdiv.shp

Field	Length	Type	Description
CSAFP	3	String	Current combined statistical area code
CBSAFP	5	String	Current metropolitan statistical area/micropolitan statistical area code
METDIVFP	5	String	Current metropolitan division code
GEOID	10	String	Metropolitan division identifier; a concatenation of metropolitan statistical area/micropolitan statistical area code and metropolitan division code
NAME	100	String	Current metropolitan division name
NAMELSAD	100	String	Current name and the translated legal/statistical area description for metropolitan division
LSAD	2	String	Current legal/statistical area description code for metropolitan division

Field	Length	Type	Description
MTFCC	5	String	MAF/TIGER feature class code (G3120)
ALAND	14	Number	Current land area
AWATER	14	Number	Current water area
INTPTLAT	11	String	Current latitude of the internal point
INTPTLON	12	String	Current longitude of the internal point

3.13.4 Metropolitan Statistical Area/Micropolitan Statistical Area (CBSA) National Shapefile Record Layout (Current)

File Name: tl_2015_us_cbsa.shp

Field	Length	Type	Description
CSAFP	3	String	Current combined statistical area code, if applicable
CBSAFP	5	String	Current metropolitan statistical area/micropolitan statistical area code
GEOID	5	String	Metropolitan statistical area/micropolitan statistical area identifier, metropolitan statistical area/micropolitan statistical area code
NAME	100	String	Current metropolitan statistical area/micropolitan statistical area name
NAMELSAD	100	String	Current name and the translated legal/statistical area description for metropolitan statistical area/micropolitan statistical area
LSAD	2	String	Current legal/statistical area description code for metropolitan statistical area/micropolitan statistical area
MEMI	1	String	Current metropolitan/micropolitan status indicator
MTFCC	5	String	MAF/TIGER feature class code (G3110)
ALAND	14	Number	Current land area
AWATER	14	Number	Current water area
INTPTLAT	11	String	Current latitude of the internal point
INTPTLON	12	String	Current longitude of the internal point

3.13.5 New England City and Town Area (NECTA) National Shapefile Record Layout (Current)

File Name: tl_2015_us_necta.shp

Field	Length	Type	Description
CNECTAFP	3	String	Current combined New England city and town area code, if applicable
NECTAFP	5	String	Current New England city and town area code
GEOID	5	String	New England city and town area identifier, New England city and town area code
NAME	100	String	Current New England city and town area name
NAMELSAD	100	String	Current name and the translated legal/statistical area description for New England city and town area
LSAD	2	String	Current legal/statistical area description code for New England city and town area
NMEMI	1	String	Current New England city and town area metropolitan/micropolitan status indicator
MTFCC	5	String	MAF/TIGER feature class code (G3210)
ALAND	14	Number	Current land area
AWATER	14	Number	Current water area
INTPTLAT	11	String	Current latitude of the internal point
INTPTLON	12	String	Current longitude of the internal point

3.13.6 New England City and Town Area (NECTA) Division National Shapefile Record Layout (Current)

File Name: tl_2015_us_nectadiv.shp

Field	Length	Type	Description
CNECTAFP	3	String	Current combined New England city and town area code, if applicable
NECTAFP	5	String	Current New England city and town area code
NCTADVFP	5	String	Current New England city and town area division code

Field	Length	Type	Description
GEOID	10	String	New England city and town area division identifier; a concatenation of New England city and town area code and New England city and town area division code
NAME	100	String	Current New England city and town area division name
NAMELSAD	100	String	Current name and the translated legal/statistical area description for New England city and town area division
LSAD	2	String	Current legal/statistical area description code for New England city and town area division
MTFCC	5	String	MAF/TIGER feature class code (G3220)
ALAND	14	Number	Current land area
AWATER	14	Number	Current water area
INTPTLAT	11	String	Current latitude of the internal point
INTPTLON	12	String	Current longitude of the internal point

3.14 Military Installations

Military installation geography and attributes are available in the following shapefile:

Military Installation National Shapefile

The Census Bureau includes landmarks such as military installations in the MAF/TIGER database for locating special features and to help enumerators during field operations. The Census Bureau adds landmark features to the database on an as-needed basis and does not attempt to ensure that all instances of a particular feature are included. For additional information about area landmarks, please see Section 3.11, Landmarks (Area and Point).

This file does not include the three point landmarks identified as military installation features in the MAF/TIGER database. These point landmarks are included in the point landmark shapefile.

Although almost all military installations have assigned 8-character National Standard (GNIS) codes, the Census Bureau has not loaded most of this data into the MAF/TIGER database. The 2015 military shapefiles contain few values in the ANSICODE field.

3.14.1 Military Installation National Shapefile Record Layout

File Name: tl_2015_us_mil.shp

Field	Length	Type	Description
ANSICODE	8	String	Official code for the landmark for use by federal agencies for data transfer and dissemination

Field	Length	Type	Description
AREAID	22	String	Area landmark identifier
FULLNAME	100	String	Concatenation of expanded text for prefix qualifier, prefix direction, prefix type, base name, suffix type, suffix direction, and suffix qualifier (as available) with a space between each expanded text field
MTFCC	5	String	MAF/TIGER feature class code
ALAND	14	Number	Land area
AWATER	14	Number	Water area
INTPTLAT	11	String	Latitude of the internal point
INTPTLON	12	String	Longitude of the internal point

3.15 Places

Place geography and attributes are available in the following shapefile:

Place State-based Shapefile (Current)

The 2015 TIGER/Line Shapefiles include both incorporated places (legal entities) and census designated places (statistical entities).

Incorporated Places are those reported to the Census Bureau as legally in existence as of January 1, 2015, under the laws of their respective states. An incorporated place is established to provide governmental functions for a concentration of people as opposed to a minor civil division (MCD), which generally is created to provide services or administer an area without regard, necessarily, to population. Places may extend across county and county subdivision boundaries, but never across state boundaries. An incorporated place usually is a city, town, village, or borough, but can have other legal descriptions. For census purposes, incorporated places exclude:

- The boroughs in Alaska (treated as equivalents of counties)
- Towns in the New England states, New York, and Wisconsin (treated as MCDs)
- The boroughs in New York (treated as MCDs)

Census Designated Places (CDPs) are the statistical counterparts of incorporated places. CDPs are delineated to provide data for settled concentrations of population that are identifiable by name, but are not legally incorporated under the laws of the state in which they are located. The boundaries usually are defined in cooperation with local partners as part of the Census Bureau's Participant Statistical Areas Program or in cooperation with tribal officials as part of the Tribal Statistical Areas Program. The boundaries of CDPs, which usually coincide with visible features or the boundary of an adjacent incorporated place or another legal entity boundary, have no legal status, nor do these places have officials elected to serve traditional municipal functions. CDP boundaries may change from one decennial census to the next with changes in the settlement pattern; a CDP with the same name as in an earlier census does not necessarily have the same boundary. There are no population size requirements for

CDPs. In the nine states of the Northeast (Connecticut, Maine, Massachusetts, New Hampshire, New Jersey, New York, Pennsylvania, Rhode Island, and Vermont) as well as Michigan, Minnesota, and Wisconsin, a CDP may represent a densely settled concentration of population within a town or township; in other instances, an entire town or township may be defined as a CDP.

Hawaii is the only state that has no incorporated places recognized by the Census Bureau. All places shown in data products for Hawaii are CDPs. By agreement with the State of Hawaii, the Census Bureau does not show data separately for the city of Honolulu, which is coextensive with Honolulu County. In Puerto Rico, which also does not have incorporated places, the Census Bureau recognizes only CDPs. The CDPs in Puerto Rico are called *comunidades* or *zonas urbanas*. Guam and the Commonwealth of the Northern Mariana Islands also have only CDP's.

Place Codes—the FIPS place code uniquely identifies a place within a state. If place names are duplicated within a state and they represent distinctly different areas, a separate code is assigned to each place name alphabetically by the primary county in which each place is located or, if both places are in the same county, alphabetically by their legal descriptions (for example, "city" before "village"). All places also have an 8-character National Standard (GNIS) code.

Dependent and Independent Places—Depending on the state, incorporated places are either dependent within, or independent of, county subdivisions or there is a mixture of dependent and independent places in the state. Dependent places are part of the county subdivision; the county subdivision code of the place is the same as that of the underlying county subdivision(s), but is different from the FIPS place code. Independent places are not part of any minor civil division (MCD) and serve as primary county subdivisions. The independent place FIPS code usually is the same as that used for the MCD for the place. The only exception is if the place is independent of the MCDs in a state in which the FIPS MCD codes are in the 90000 range. Then, the FIPS MCD and FIPS place codes will differ. CDPs are always dependent within county subdivisions and all places are dependent within statistical county subdivisions.

Independent Cities- Baltimore city, MD; St. Louis city, MO; Carson city, NV; and all 38 cities in Virginia are not part of any surrounding county and are treated as both equivalent to a county and an MCD (in MCD states). The FIPS code for St. Louis city is the same as the FIPS county subdivision code. All the others have differing FIPS place and county subdivision codes. At the county level, independent cities have a 3-character county code of 500 or higher.

Geographic Corridors and Offset Geographic Boundaries—A geographic corridor (formerly called corporate corridor) is a narrow, linear part of an incorporated place (or in a very few instances, another type of legal entity). The geographic corridor includes the street and/or right-of-way or a portion of the street and/or right-of-way within the incorporated place. It excludes from the incorporated place those structures such as houses, apartments, or businesses that front along the street or road.

A geographic limit offset boundary (formerly called corporate limit offset boundary) exists where the incorporated place lies on only one side of the street and may include all or part of the street and/or the right-of-way. It does not include the houses or land that adjoins the side of the street with the geographic limit offset boundary. It is possible to have two or more geographic limit offset boundaries in the same street or right-of-way. Geographic limit offset boundaries use the same map symbology as non-offset boundaries. Figures 3 and 4 depict geographic corridors and geographic offset limits.

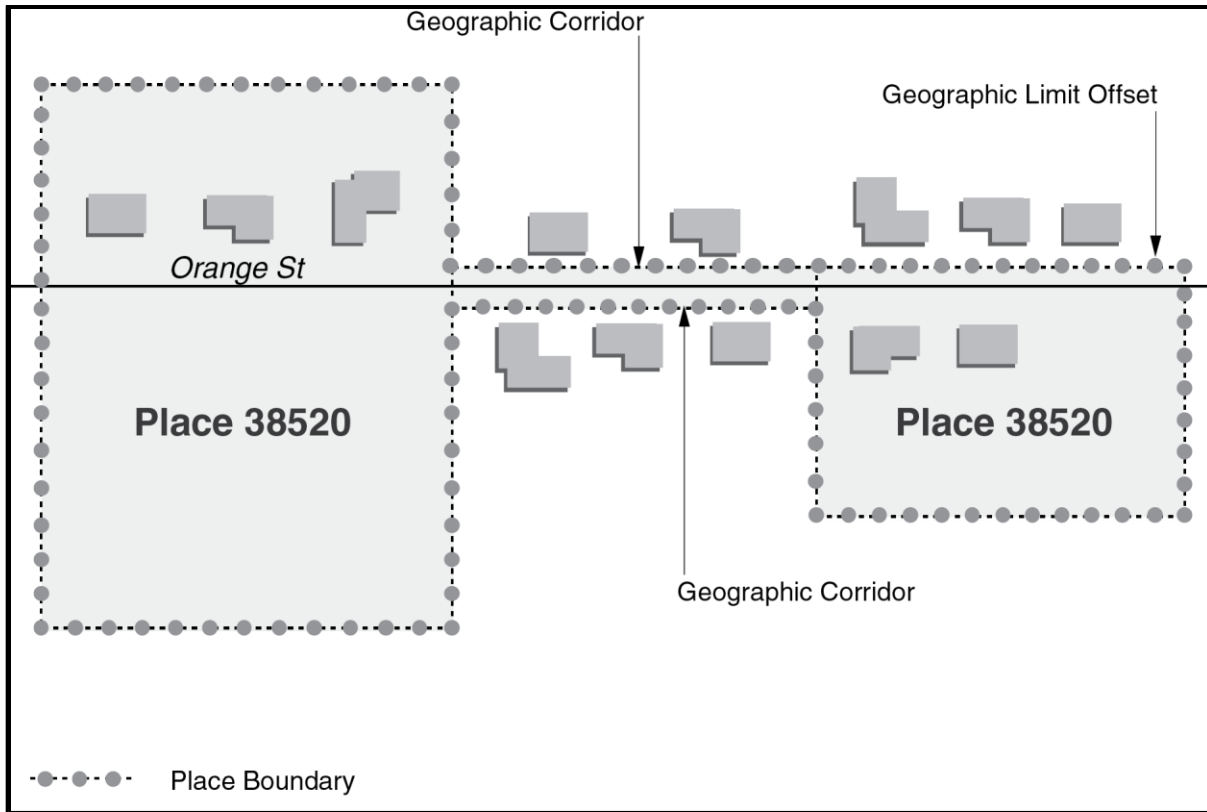

Figure 3: Geographic Corridors – Overview

This diagram, using symbology typical of a census map, shows a geographic corridor linking the two larger areas of Place 38520 (shading has been added to highlight the actual area within the corporate limits). Part of the geographic limit along Orange St. is an offset boundary. A geographic limit offset covers only one side of the street or right-of-way, not the entire street or right-of-way, as is the case with a geographic corridor.

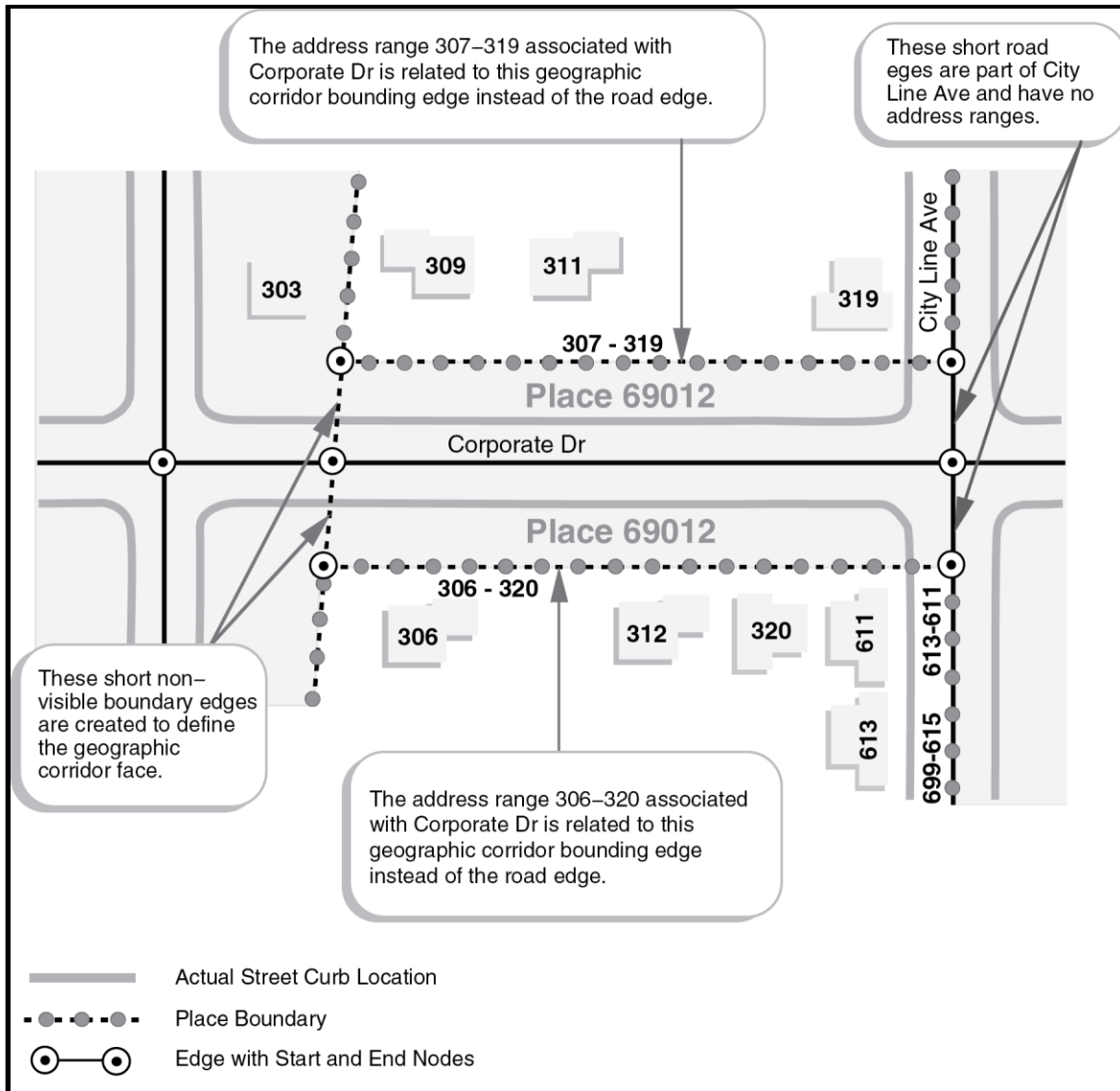

Figure 4: Geographic Corridors Address Ranges

This diagram shows the address ranges associated with a geographic corridor that runs along Corporate Dr. In order to correctly geocode structures outside the geographic corridor in the correct block and place, the address ranges associated with Corporate Dr. are located on and related to the geographic corridor bounding edge instead of the road edge. For example, 311 Corporate Dr. is located outside the geographic limits. Using address ranges on the road edge for Corporate Dr. will incorrectly geocode the structure to Place 69012. Assigning the address ranges to the geographic corridor edge along side Corporate Dr. will correctly geocode the structure to the block outside of Place 69012. Note that the geographic corridor edge splits City Line Ave. road edge at one end of the corridor. In this case, the road edge outside of the geographic corridor is assigned the address range and the road edge for City Line Ave. inside the corridor does not have address ranges.

Geographic corridor address ranges are related by using the All Lines Shapefile and Address Ranges Relationship File permanent edge identifier (TLID) to the corridor bounding edge adjacent to the road edge. The street names are related to the address ranges on the geographic corridor bounding edges

through the Address Range-Feature Name Relationship File. By assigning the address range to the geographic corridor edge rather than the road edge, structures will geocode correctly outside of the geographic corridor.

Consolidated City (Balance) Portions refer to the areas of a consolidated city not included in another separately incorporated place. For example, Butte-Silver Bow, MT, is a consolidated city (former Butte city and Silver Bow County) that includes the separately incorporated municipality of Walkerville city. The area of the consolidated city that is not in Walkerville city is assigned to Butte-Silver Bow (balance). The name always includes the “(balance)” identifier. Balance portions of consolidated cities are included in the place shapefiles.

3.15.1 Place State-based Shapefile Record Layout (Current)

File Name: tl_2015_<stateFIPS>_place.shp

Field	Length	Type	Description
STATEFP	2	String	Current state FIPS code
PLACEFP	5	String	Current place FIPS code
PLACENS	8	String	Current place GNIS code
GEOID	7	String	Place identifier; a concatenation of the current state FIPS code and place FIPS code
NAME	100	String	Current place name
NAMELSAD	100	String	Current name and the translated legal/statistical area description for place
LSAD	2	String	Current legal/statistical area description code for place
CLASSFP	2	String	Current FIPS class code
PCICBSA	1	String	Current metropolitan or micropolitan statistical area principal city indicator
PCINECTA	1	String	Current New England city and town area principal city indicator
MTFCC	5	String	G4110 (incorporated place) and G4210 (census designated place)
FUNCSTAT	1	String	Current functional status
ALAND	14	Number	Current land area
AWATER	14	Number	Current water area
INTPTLAT	11	String	Current latitude of the internal point

Field	Length	Type	Description
INTPTLON	12	String	Current longitude of the internal point

3.16 Public Use Microdata Areas (PUMAs)

Public use microdata area geography and attributes are available in the following shapefile:

Public Use Microdata Area (PUMA) State-based Shapefile (2010 Census)

Public use microdata areas (PUMAs) are decennial census areas that have been defined for the tabulation and dissemination of Public Use Microdata Sample (PUMS) data, American Community Survey (ACS) data, and ACS period estimates.

For the 2010 Census, the State Data Centers (SDCs) in each state, the District of Columbia, and the Commonwealth of Puerto Rico were given the opportunity to delineate PUMAs within their state or statistically equivalent entity. All PUMAs must nest within states and have a minimum population threshold of 100,000 persons. 2010 PUMAs were built on census tracts and cover the entirety of the United States, Puerto Rico, Guam, and the U.S. Virgin Islands. Because they do not meet the minimum population requirement, the Commonwealth of the Northern Mariana Islands and American Samoa do not contain any 2010 PUMAs.

For more detailed information about PUMAs, please visit the Public Use Microdata Areas (PUMAs) website at:

<http://www.census.gov/geo/reference/puma.html>.

3.16.1 Public Use Microdata Area (PUMA) State-based Shapefile Record Layout (2010 Census)

File Name: tl_2015_<stateFIPS>_puma10.shp

Field	Length	Type	Description
STATEFP10	2	String	2010 Census state FIPS code
PUMACE10	5	String	2010 Census Public Use Microdata Area code
GEOID10	7	String	2010 Census nation-based Public Use Microdata Area code; a concatenation of 2010 Census state FIPS code and Public Use Microdata Area code
NAMELSAD10	100	String	2010 Census translated legal/statistical area description code and Public Use Microdata Area name
MTFCC10	5	String	MAF/TIGER feature class code
FUNCSTAT10	1	String	2010 Census functional status
ALAND10	14	Number	2010 Census land area
AWATER10	14	Number	2010 Census water area

Field	Length	Type	Description
INTPTLAT10	11	String	2010 Census latitude of the internal point
INTPTLON10	12	String	2010 Census longitude of the internal point

3.17 School Districts (Elementary, Secondary, and Unified)

School district geography and attributes are available in the following shapefiles:

- Elementary School District State-based Shapefile (Current)
- Secondary School District State-based Shapefile (Current)
- Unified School District State-based Shapefile (Current)

School Districts are single-purpose administrative units within which local officials provide public educational services for the area's residents. The Census Bureau obtains school district boundaries, names, local education agency codes, grade ranges, and school district levels biennially from state education officials. The Census Bureau collects this information for the primary purpose of providing the U.S. Department of Education with annual estimates of the number of children in poverty within each school district, county, and state. This information serves as the basis for the Department of Education to determine the annual allocation of Title I funding to states and school districts.

The 2015 TIGER/Line Shapefiles include separate shapefiles for elementary, secondary, and unified school districts. The 2015 shapefiles contain information from the 2013-2014 school year, i.e. districts in operation as of January 1, 2014.

The elementary school districts provide education to the lower grade/age levels and the secondary school districts provide education to the upper grade/age levels. The unified school districts are districts that provide education to children of all school ages. In general, where there is a unified school district, no elementary or secondary school district exists (see exceptions described below) and where there is an elementary school district, the secondary school district may or may not exist (see explanation below). In addition to regular functioning school districts, the TIGER/Line Shapefiles contain pseudo-school districts (see description below).

The Census Bureau's representation of school districts is based on the grade ranges for which the school district is financially responsible, which may or may not be the grade ranges that a school district operates. (The grade range that reflects financial responsibility is important for the allocation of Title I funds.) A typical example would be a school district that operates schools for children in grades Kindergarten (KG)-8 and pays for a neighboring school district to educate children in grades 9–12. The first school district is operationally responsible for grades K-8, but financially responsible for grades KG-12. Therefore, the Census Bureau would define the grade range for that school district as KG-12. If an elementary school district is financially responsible for grades KG-12 or Pre-Kindergarten (PK)–12, there will be no secondary school district represented for that area. In cases, where an elementary school district is financially responsible for only lower grades, there is generally a secondary school district that is financially responsible for providing educational services for the upper grades.

The following are exceptions to the above information:

The Census Bureau depicts the State of Hawaii as one unified school district and the five counties that represent the five boroughs of New York City as one unified school district.

In the school district shapefiles, California, Georgia, Illinois, Kentucky, Massachusetts, Minnesota, Oklahoma, South Carolina, Tennessee, Texas, and Vermont contain pseudo-secondary school districts that represent regular unified school districts in areas where the unified school districts share financial responsibility service with elementary school districts. These pseudo-secondary school districts were created and linked to real unified school districts in order for the Census Bureau to allocate the high school aged children to the unified school districts. The Census Bureau could not assign the official unified school district codes, but had to create pseudo-school district codes to represent a service area where the unified school district is financially responsible for less than the entire KG-12 grade range. In these areas, there were no regular functioning secondary school districts serving the area and the elementary school districts in these areas were not paying tuition to the unified school districts (that is, the elementary school districts' financial responsibilities did not extend to grade 12).

A list of these pseudo-secondary school districts and their codes appears in Appendix A.

School District Codes—the 2015 TIGER/Line Shapefiles contain 5-character school district codes. The value 99997 is the school district code assigned to water or land where no official school district is defined by a state. The school district codes are the local education agency codes used by the U.S. Department of Education and are unique within a state.

School District Names—the names of school districts include their description and no other field (NAMELSAD) is required.

3.17.1 Elementary School District State-based Shapefile Record Layout (Current)

File Name: tl_2015_<stateFIPS>_elsd.shp

Field	Length	Type	Description
STATEFP	2	String	Current state FIPS code
ELSDLEA	5	String	Current elementary school district local education agency code
GEOID	7	String	School district identifier; a concatenation of the current state FIPS code and elementary school district local education agency code
NAME	100	String	Current elementary school district name
LSAD	2	String	Current legal/statistical area description code for elementary school district
LOGRADE	2	String	Current lowest grade covered by school district
HIGRADE	2	String	Current highest grade covered by school district
MTFCC	5	String	MAF/TIGER feature class code (G5400)
SDTYP	1	String	Current school district type
FUNCSTAT	1	String	Current functional status

Field	Length	Type	Description
ALAND	14	Number	Current land area
AWATER	14	Number	Current water area
INTPTLAT	11	String	Current latitude of the internal point
INTPTLON	12	String	Current longitude of the internal point

3.17.2 Secondary School District State-based Shapefile Record Layout (Current)

File Name: tl_2015_<stateFIPS>_scsd.shp

Field	Length	Type	Description
STATEFP	2	String	Current state FIPS code
SCSDLEA	5	String	Current secondary school district local education agency code
GEOID	7	String	School district identifier; a concatenation of the current state FIPS code and secondary school district local education agency code
NAME	100	String	Current secondary school district name
LSAD	2	String	Current legal/statistical area description code for secondary school district
LOGRADE	2	String	Current lowest grade covered by school district
HIGRADE	2	String	Current highest grade covered by school district
MTFCC	5	String	MAF/TIGER feature class code (G5410)
SDTYP	1	String	Current school district type
FUNCSTAT	1	String	Current functional status
ALAND	14	Number	Current land area
AWATER	14	Number	Current water area
INTPTLAT	11	String	Current latitude of the internal point
INTPTLON	12	String	Current longitude of the internal point

3.17.3 Unified School District State-based Shapefile Record Layout (Current)

File Name: tl_2015_<stateFIPS>_unsd.shp

Field	Length	Type	Description
STATEFP	2	String	Current state FIPS code
UNSDLEA	5	String	Current unified school district local education agency code
GEOID	7	String	School district identifier; a concatenation of the current state FIPS code and unified school district local education agency code
NAME	100	String	Current unified school district name
LSAD	2	String	Current legal/statistical area description code for unified school district
LOGRADE	2	String	Current lowest grade covered by school district
HIGRADE	2	String	Current highest grade covered by school district
MTFCC	5	String	MAF/TIGER feature class code (G5420)
SDTYP	1	String	Current school district type
FUNCSTAT	1	String	Current functional status
ALAND	14	Number	Current land area
AWATER	14	Number	Current water area
INTPTLAT	11	String	Current latitude of the internal point
INTPTLON	12	String	Current longitude of the internal point

3.18 States and State Equivalent Entities

State and equivalent entity geography and attributes are available in the following shapefile:

State and Equivalent Entity National Shapefile (Current)

States and equivalent entities are the primary governmental divisions of the United States. In addition to the fifty states, the Census Bureau treats the District of Columbia, Puerto Rico, and the Island areas (American Samoa, the Commonwealth of the Northern Mariana Islands, Guam, and the U.S. Virgin Islands) as the statistical equivalents of states for the purpose of data presentation. Census regions and divisions consist of groupings of states and equivalent entities. The codes for these areas are included in the state shapefiles and the state records can be merged to form those areas.

3.18.1 State and Equivalent Entity National Shapefile Record Layout (Current)

File Name: tl_2015_us_state.shp

Field	Length	Type	Description
REGION	2	String	Current region code
DIVISION	2	String	Current division code
STATEFP	2	String	Current state FIPS code
STATENS	8	String	Current state GNIS code
GEOID	2	String	State identifier; state FIPS code
STUSPS	2	String	Current United States Postal Service state abbreviation
NAME	100	String	Current state name
LSAD	2	String	Current legal/statistical area description code for state
MTFCC	5	String	MAF/TIGER feature class code (G4000)
FUNCSTAT	1	String	Current functional status
ALAND	14	Number	Current land area
AWATER	14	Number	Current water area
INTPTLAT	11	String	Current latitude of the internal point
INTPTLON	12	String	Current longitude of the internal point

3.19 State Legislative Districts (Upper and Lower)

State legislative district geography and attributes are available in the following shapefiles:

- State Legislative District Lower Chamber (SLDL) State-based Shapefile (Current)
- State Legislative District Upper Chamber (SLDU) State-based Shapefile (Current)

State legislative districts are the areas from which members are elected to state or equivalent entity legislatures. The state legislative district embodies the upper (senate—SLDU) and lower (house—SLDL) chambers of the state legislature. The Census Bureau first reported data for state legislative districts as part of the 2000 Public Law (P.L.) 94-171 Redistricting Data File for the states that choose to submit them and the boundaries are updated every two years as time permits, in years ending in an even number.

State Legislative Districts (2014 Election Year) - All 50 states, plus the District of Columbia and Puerto Rico, participated in Phase 4 of the 2010 Census Redistricting Program, as part of P.L. 94-171. They voluntarily provided the Census Bureau with the 2012 election cycle boundaries, codes, and in some cases names for their state legislative districts. States provided updates for their boundaries used in the November 2014 elections for the session that began in January 2015.

The following states or equivalents had changes to their state legislative districts for 2014:

Alaska
 District of Columbia (upper house only)
 Georgia (upper house only)

Kentucky
 Maine
 Minnesota

Montana
 Pennsylvania
 Texas (lower house only)

Nebraska has a unicameral legislature and the District of Columbia has a single council, both of which the Census Bureau treats as upper-chamber legislative areas for the purpose of data presentation. Therefore, there are no data by the lower house of the state legislative districts for either Nebraska or the District of Columbia.

State Legislative District Codes - A unique 3-character census code, identified by state participants, is assigned to each state legislative district upper (senate) and lower (house) within a state. In Connecticut, Illinois, Louisiana, Maine, Maryland, Massachusetts, Michigan, Ohio, and Puerto Rico, the state participant did not assign the current state legislative districts to cover all of the state or equivalent area. The code "ZZZ" has been assigned to areas with no state legislative districts defined (usually large water bodies). These unassigned areas are treated within state as a single state legislative district for purposes of data presentation.

Other Notes on State Legislative Districts

- The state of Ohio generated their state legislative plans using custom geography from the state's Ohio Common and Unified Redistricting Database produced by Cleveland State University. These shapefiles approximate those plans using Census Bureau geography. The states of Maryland and New York adjusted the 2010 Census P.L. [94-171] redistricting data for their respective states by reallocating state prisoner populations to their last known residence. Information on these adjustments is available by visiting each state's website: MD <http://www.planning.maryland.gov/redistricting/homes.html>; NY <http://www.lafor.state.ny.us/>.
- The state of Hawaii adjusted the 2010 Census P.L. [94-171] redistricting data to remove non-resident military personnel and non-resident students. Information on this adjustment is available at <http://hawaii.gov/elections/reapportionment>.
- The state of Kansas adjusted the 2010 Census P.L. [94-171] redistricting data to exclude non-resident students and non-resident military personnel and to include resident students and members of the military at the place of their permanent residence for state legislative redistricting. Information on this adjustment is available at <http://redistricting.ks.gov/index.html>.
- The state of New Hampshire uses floterial districts in their lower-chamber (SLDL) plan. Floterial districts are overlay districts made up of two or more discrete districts. These discrete or component districts are those represented in the New Hampshire SLDL shapefile. A listing of the floterial districts and their component districts is available as a report (pdf) at http://www.census.gov/rdo/pdf/NH_2012_Floterial_List.pdf.

3.19.1 State Legislative District Lower Chambers (SLDL) State-based Shapefile Record Layout (Current)

File Name: tl_2015_<stateFIPS>_sldl.shp

Field	Length	Type	Description
STATEFP	2	String	Current state FIPS code
SLDLST	3	String	Current state legislative district lower chamber code

Field	Length	Type	Description
GEOID	5	String	State legislative district lower chamber identifier; a concatenation of the current state FIPS code and state legislative district lower chamber code
NAMELSAD	100	String	Current name and the translated legal/statistical area description for state legislative district lower chamber
LSAD	2	String	Current legal/statistical area description code for state legislative district lower chamber
LSY	4	String	Legislative session year
MTFCC	5	String	MAF/TIGER feature class code (G5220)
FUNCSTAT	1	String	Current functional status
ALAND	14	Number	Current land area
AWATER	14	Number	Current water area
INTPTLAT	11	String	Current latitude of the internal point
INTPTLON	12	String	Current longitude of the internal point

3.19.2 State Legislative District Upper Chambers (SLDU) State-based Shapefile Record Layout (Current)

File Name: tl_2015_<stateFIPS>_sldu.shp

Field	Length	Type	Description
STATEFP	2	String	Current state FIPS code
SLDUST	3	String	Current state legislative district upper chamber code
GEOID	5	String	State legislative district upper chamber identifier; a concatenation of the current state FIPS code and state legislative district upper chamber code
NAMELSAD	100	String	Current name and the translated legal/statistical area description for state legislative district upper chamber
LSAD	2	String	Current legal/statistical area description code for state legislative district upper chamber
LSY	4	String	Legislative session year
MTFCC	5	String	MAF/TIGER feature class code (G5210)

Field	Length	Type	Description
FUNCSTAT	1	String	Current functional status
ALAND	14	Number	Current land area
AWATER	14	Number	Current water area
INTPTLAT	11	String	Current latitude of the internal point
INTPTLON	12	String	Current longitude of the internal point

3.20 Subbarrio (Subminor Civil Division)

Subbarrio (Subminor civil division - sub-MCD) geography and attributes are available in Puerto Rico in the following shapefile:

Subbarrio (SubMinor Civil Division) State-based Shapefile (Current)

Subbarrios, located in Puerto Rico, are legally defined subdivisions of minor civil divisions (MCDs) named barrios-pueblo and barrios. Subbarrios do not exist within every MCD in Puerto Rico nor do they necessarily cover the entire area of an MCD where they do exist. The Puerto Rico Planning Board through the Boundary and Annexation Survey provided the boundaries of the subbarrios to the Census Bureau. The subbarrio boundaries are as of January 1, 2015. For more information, please visit: <http://www.census.gov/geo/partnerships/bas.html>.

The 2015 TIGER/Line Shapefiles contain the 5-character FIPS codes for subbarrios as well as 8-character National Standard (GNIS) codes.

3.20.1 Subbarrio (Subminor Civil Division) State-based Shapefile Record Layout (Current)

File Name: tl_2015_72_subbarrio.shp

Field	Length	Type	Description
STATEFP	2	String	Current state FIPS code
COUNTYFP	3	String	Current county FIPS code
COUSUBFP	5	String	Current county subdivision FIPS code
SUBMCDFP	5	String	Current subminor civil division FIPS code
SUBMCDNS	8	String	Current subminor civil division GNIS code
GEOID	15	String	Subminor civil division identifier; a concatenation of current state FIPS code, county FIPS code, county subdivision FIPS code, and subminor civil division FIPS code
NAME	100	String	Current subbarrio name

Field	Length	Type	Description
NAMELSAD	100	String	Current name and the translated legal/statistical area description for subbarrio
LSAD	2	String	Current legal/statistical area description code for subbarrio
CLASSFP	2	String	Current FIPS class code
MTFCC	5	String	MAF/TIGER feature class code (G4060)
FUNCSTAT	1	String	Current functional status
ALAND	14	Number	Current land area
AWATER	14	Number	Current water area
INTPTLAT	11	String	Current latitude of the internal point
INTPTLON	12	String	Current longitude of the internal point

3.21 Topological Faces (Polygons with All Geocodes)

Topological face information is available in the following shapefile:

Topological Faces (Polygons with All Geocodes) County-based Shapefile (Current)

The Topological Faces shapefile contains the attributes of each topological primitive face. The attributes associated with each face in this shapefile contain both current census block and the 2010 census block information. The Census Bureau created a set of census blocks for the 2010 Census, which are identified by a 4-character number, with the first number representing the block group they are in. Throughout the decade, changes to the census blocks occur due to boundary changes, such as changes in incorporated places, legislative districts, and census tracts and the block may be split into more than one piece. If a split occurs, the original census block number is kept and an alpha character suffix is added (e.g. block 1001A and 1001B). In a few cases, especially with census tract and block group changes, the first digit in the census block number may no longer represent the block group it falls in.

Due to potential updates to the codes, it is important not to mix 2010 Census geographic codes with current geographic codes. A block can only be unique by using the decennial census state, county, tract, and block group, or STATEFP10 + COUNTYFP10 + TRACTCE10 + BLKGRPCE10, to get the correct block group corresponding to the BLOCKCE or BLOCKCE10. (Note that BLOCKCE10 and BLCOCKCE are always identical.) Replacing any of these decennial codes with current codes can lead to false duplicate and/or noncontiguous blocks, as well as state, county, tract, and/or block group changes.

3.21.1 Topological Faces (Polygons with All Geocodes) County-based Shapefile Record Layout (Current)

File Name: tl_2015_<state-countyFIPS>_faces.shp

Field	Length	Type	Description
-------	--------	------	-------------

Field	Length	Type	Description
TFID	10	Integer	Permanent face ID
STATEFP10	2	String	2010 Census state FIPS code
COUNTYFP10	3	String	2010 Census county FIPS code
TRACTCE10	6	String	2010 Census census tract code
BLKGRPCE10	1	String	2010 Census block group number
BLOCKCE10	4	String	2010 Census tabulation block number
SUFFIX1CE	1	String	Current Census block suffix 1
ZCTA5CE10	5	String	2010 Census 5-digit ZCTA code
UACE10	5	String	2010 Census urban area code
PUMACE10	5	String	2010 Census public use microdata area code
STATEFP	2	String	Current state FIPS code
COUNTYFP	3	String	Current county FIPS code
TRACTCE	6	String	Current census tract code
BLKGRPCE	1	String	Current block group number
COUSUBFP	5	String	Current county subdivision FIPS code
SUBMCDFP	5	String	Current subminor civil division FIPS code
ESTATEFP	5	String	Current estate FIPS code
CONCTYFP	5	String	Current consolidated city FIPS code
PLACEFP	5	String	Current place FIPS code
AIANNHFP	5	Number	Current American Indian/Alaska Native/Native Hawaiian area FIPS code
AIANNHCE	4	String	Current American Indian/Alaska Native/Native Hawaiian area census code
COMPTYP	1	String	Current American Indian/Alaska Native/Native Hawaiian area reservation/statistical area or off-reservation trust land Hawaiian home land indicator
TRSUBFP	5	Number	Current American Indian tribal subdivision FIPS code

Field	Length	Type	Description
TRSUBCE	3	String	Current American Indian tribal subdivision code
ANRCFP	5	String	Current Alaska Native Regional Corporation FIPS code
TTRACTCE	6	String	Current tribal census tract code
TBLKGPCE	1	String	Current tribal block group letter
ELSDLEA	5	String	Current elementary school district local education agency code
SCSDLEA	5	String	Current secondary school district local education agency code
UNSDLEA	5	String	Current unified school district local education agency code
CD114FP	2	String	114th congressional district FIPS code
SLDUST	3	String	Current state legislative district upper chamber code
SLDLST	3	String	Current state legislative district lower chamber code
CSAFP	3	String	Current combined statistical area code
CBSAFP	5	String	Current metropolitan statistical area/micropolitan statistical area code
METDIVFP	5	String	Current Metropolitan division code
CNECTAFP	3	String	Current combined New England city and town area code (New England states only)
NECTAFP	5	String	Current New England city and town area code (New England states only)
NCTADVFP	5	String	Current New England city and town area division code (New England states only)
LWFLAG	1	String	Land/water flag
OFFSET	1	String	Geographic corridor/offset flag
ATOTAL	14	Number	Total area
INTPTLAT	11	String	Latitude of the internal point
INTPTLON	12	String	Longitude of the internal point

3.22 Urban Areas

Urban area geography and attributes are available in the following shapefile:

Urban Area National Shapefile (2010 Census)

For the 2010 Census, the Census Bureau classified all territory, population, and housing units located within urbanized areas (UAs) and urban clusters (UCs) as urban. The Census Bureau delineates UA and UC boundaries to represent densely developed territory, encompassing residential, commercial, and other non-residential urban land uses. In general, this territory consists of areas of high population density and urban land use resulting in a representation of the “urban footprint.” Territory, population, and housing units located outside of UAs and UCs is considered rural.

For the 2010 Census the urban and rural classification was applied to the 50 states, the District of Columbia and Puerto Rico. Per agreements with the Island Areas, minor modifications to the classification were implemented when applied to American Samoa, Guam, the Commonwealth of the Northern Mariana Islands, and the U.S. Virgin Islands.

Urbanized Areas (UAs)—an urbanized area consists of densely developed territory that contains 50,000 or more people. The Census Bureau delineates UAs to provide a better separation of urban and rural territory, population, and housing in the vicinity of large places. The Census Bureau first introduced the urbanized area concept for the 1950 Census.

Urban Clusters (UCs)—an urban cluster consists of densely developed territory that has at least 2,500 but fewer than 50,000 people. The Census Bureau first introduced the UC concept for Census 2000 to provide a more consistent and accurate measure of urban population, housing, and territory throughout the United States, Puerto Rico, and the Island Areas. Based on agreements with Guam, the Commonwealth of the Northern Mariana Islands, and the U.S. Virgin Islands, all qualifying urban areas are identified as urban clusters regardless of their final population counts. Thus, urban clusters may exceed 50,000 people in these areas.

Urban Area Titles and Codes—The title of each UA and UC may contain up to three incorporated place or census designated place (CDP) names, and will include the 2-letter U.S. Postal Service abbreviation for each state or statistically equivalent entity into which the UA or UC extends. However, if the UA or UC does not contain an incorporated place or CDP, the urban area title will include the single name of a minor civil division or populated place recognized by the U.S. Geological Survey’s Geographic Names Information System (GNIS).

Each UC and UA is assigned a 5-character code, based on a national alphabetical sequence of all urban area names. A separate flag is included in data tabulation files to differentiate between UAs and UCs. In printed reports, this differentiation is included in the name.

Relationship to Other Geographic Entities— Urban Areas are delineated at the block level. Urban Areas may cross the boundaries of all other geographic areas for which the Census Bureau presents data, which means that all areas, other than blocks, may include a both urban and rural areas. For more information, visit:

<http://www.census.gov/geo/reference/urban-rural.html>.

3.22.1 Urban Area (UA) National Shapefile Record Layout (2010 Census)

File Name: tl_2015_us_uac10.shp

Field	Length	Type	Description
UACE10	5	String	2010 Census urban area code
GEOID10	5	String	2010 Census urban area identifier; 2010 Census urban area code
NAME10	100	String	2010 Census urban area name
NAMELSAD10	100	String	2010 Census name and the translated legal/statistical area description for urban area
LSAD10	2	String	2010 Census legal/statistical area description code for urban area
MTFCC10	5	String	MAF/TIGER feature class code (G3500)
UATYP10	1	String	2010 Census urban area type
FUNCSTAT10	1	String	2010 Census functional status
ALAND10	14	Number	2010 Census land area
AWATER10	14	Number	2010 Census water area
INTPTLAT10	11	String	2010 Census latitude of the internal point
INTPTLON10	12	String	2010 Census longitude of the internal point

3.23 ZIP Code Tabulation Areas (5-digit)

ZIP Code tabulation area geography and attributes are available in the following shapefile:

5-Digit ZIP Code Tabulation Area (ZCTA5) National Shapefile (2010 Census)

ZIP Code tabulation areas (ZCTAs) are approximate area representations of U.S. Postal Service (USPS) 5-digit ZIP Code service areas that the Census Bureau creates using census blocks to present statistical data from censuses and surveys. The Census Bureau defines ZCTAs by allocating each block that contains addresses to a single ZIP Code tabulation area, usually to the ZCTA that reflects the most frequently occurring ZIP Code for the addresses within that block. Blocks that do not contain addresses but are completely surrounded by a single ZIP Code tabulation area (enclaves) are assigned to the surrounding ZCTA; those surrounded by multiple ZCTAs will be added to a single ZCTA based on the longest shared border. The Census Bureau identifies 5-digit ZIP Code tabulation areas using a 5-character numeric code that represents the most frequently occurring USPS ZIP Code within that ZCTA and this code may contain leading zeros.

Data users should not use ZCTAs to identify the official USPS ZIP Code for mail delivery. The USPS makes periodic changes to ZIP Codes to support more efficient mail delivery. The ZCTA delineation process used primarily residential addresses and was biased towards ZIP Codes used for city-style mail delivery, thus there may be ZIP Codes that cover primarily nonresidential or post office box addresses that may not have a corresponding ZCTA.

ZIP Code Tabulation Area Codes—The Census Bureau identifies 5-digit ZCTAs using a 5-digit code. For more information, visit:

<http://www.census.gov/geo/reference/zctas.html>.

3.23.1 5-Digit ZIP Code Tabulation Area (ZCTA) National Shapefile Record Layout (2010 Census)

File Name: tl_2015_us_zcta510.shp

Field	Length	Type	Description
ZCTA5CE10	5	String	2010 Census 5-digit ZIP Code Tabulation Area code
GEOID10	5	String	2010 Census 5-digit ZIP Code Tabulation Area identifier, 2010 Census 5-digit ZIP Code Tabulation Area code
CLASSFP10	2	String	2010 Census FIPS 55 class code
MTFCC10	5	String	MAF/TIGER feature class code (G6350)
FUNCSTAT10	1	String	2010 Census functional status
ALAND10	14	Number	2010 Census land area
AWATER10	14	Number	2010 Census water area
INTPTLAT10	11	String	2010 Census latitude of the internal point
INTPTLON10	12	String	2010 Census longitude of the internal point

4. Relationship File Concept Overview

Relationships files are database files that provide additional attribute information that users can join to the TIGER/Line Shapefiles. The following sections describe the geographic entity type displayed in each relationship file, as well as the record layout for each file. Each entity type is listed in alphabetical order.

4.1 Address Ranges

Address range information is available in the following relationship file:

Address Ranges County-based Relationship File

The term “address range” refers to the collection of all possible structure numbers from the first structure number to the last structure number and all numbers of a specified parity in between. Address ranges fall along an edge side relative to the direction in which the edge is coded. The 2015 TIGER/Line Shapefiles contain potential address ranges, not individual addresses. Potential ranges include the full range of possible structure numbers even though the actual structures might not exist (see Figure 5).

The address ranges relationship file contains the attributes of each address range. Each address range applies to a single edge side and has a unique address range identifier (ARID) value. The edge to which an address range applies can be determined by linking the address range to the All Lines shapefile using the permanent edge identifier (TLID) attribute. Multiple address ranges can apply to the same edge because addresses with different number sequences (e.g., 101, 103, 1622, 1624...) or non-numeric characters (e.g., N101, N103, S099, S97) can appear along that edge. Note that the most inclusive address range associated with each side of a street edge appears in the All Lines shapefile.

The most inclusive address range has the largest range of potential house number values of all address ranges associated with the side of an edge. It is not a composite of the available address ranges. The Census Bureau provides the most inclusive address ranges for data users looking for data comparable to the address ranges supplied in the Record Type 1 (RT1) of the TIGER/Line data files.

ZIP Codes and Address Ranges

The address numbers used to create the address ranges are commonly known as house number-street name style addresses (or city-style addresses). A house number-street name style address minimally consists of a structure number, street name, and a 5-digit ZIP Code; for example, 213 Main Street 90210. In the 2015 TIGER/Line Shapefiles, ZIP Codes are only associated to address ranges.

The ZIP Code is an attribute of the address ranges. The Address Ranges Relationship File has a 5-digit ZIP Code field containing a numeric code that may have leading zeroes. Both sides of a street typically have the same ZIP Code, but this is not always true. Different ZIP Codes may serve different sides of a street or cover addresses at each end of a street. Nearly all address ranges will have a ZIP Code, but there are a few instances where the ZIP Code is not known and the ZIP Code will have a null/blank value.

The 2015 TIGER/Line Shapefiles may not contain all street delivery ZIP Codes and may contain some non-delivery ZIP Codes. In some cases, P.O. Box delivery ZIP Codes may be associated with house number-street name style addresses that are not used for mail delivery (see below). The distribution of ZIP Codes in the TIGER/Line Shapefiles may not reflect the exact USPS ZIP Code service area. Likewise, the address range ZIP Codes may not match the ZIP Code Tabulation Area (ZCTA) for the area.

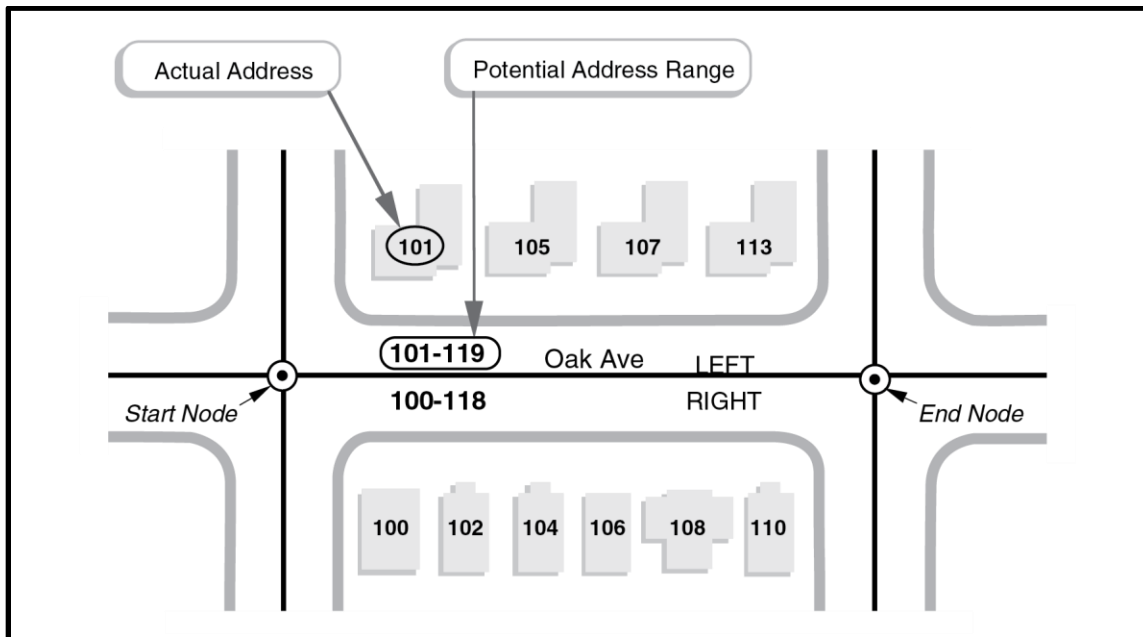

Figure 5: TIGER/Line Shapefiles Address Range Basics

The TIGER/Line Shapefiles contain potential address ranges for city-style addresses. The edge (between the start node and the end node) in the diagram above has two address ranges; the left side has odd-numbered addresses and the right side has the complementary even-numbered addresses. Potential address ranges along an edge have values that encompass the addresses of existing structures, as well as those not yet built.

Note: The most inclusive address range has the largest range of potential house number values of all address ranges associated with the side on an edge. It is not a composite of the available address ranges.

Table 5: Address range product comparison table

Layer Name	Filename	Spatial Data	Address Ranges	Geocoding Usability
All Lines Shapefile	edge.shp	Yes	Most inclusive address ranges	Limited geocoding
Address Range Feature Shapefile	addrfeat.shp	Yes	All address ranges	Best source for geocoding
Address Range Table	addr.dbf	No	All address ranges	No geocoding
Address Range to Feature Name Relationship Table	addrfn.dbf	No	No address ranges	No geocoding

Some basic characteristics of address ranges are as follows:

- The 2015 TIGER/Line Shapefiles generally contain address ranges with only house number-street name style addresses. They do not show rural route and post office box addresses. They may contain structure numbers assigned in select areas for use by local emergency services, but not for mail delivery. The 2015 TIGER/Line Shapefiles do include address ranges and ZIP Codes in some small places where the USPS provides only post office box service. These address ranges represent the structure numbers collected during the 2000 and 2010 census field operations, supplemented with addresses provided through local participant programs and intercensal Census Bureau activities and updates. These structure-number addresses may have ZIP Codes associated only with post office box addresses. The USPS does not recognize these street addresses as valid mailing addresses and does not assign a ZIP+4 Code to them or include them in the ZIP+4 file. The address ranges may be used to geocode a structure to the census block, but care should be used because of potential conflicts with similar or duplicate mailing street addresses.
- Gaps may exist between multiple ranges for a single edge. A gap may be significant because any numbers missing from one edge may actually appear on another edge. This situation occurs in cases where there are address anomalies such as out-of-parity or out-of-sequence addresses. The Census Bureau does not provide any single address-address ranges in the 2015 TIGER/Line Shapefiles, including out-of-parity and out-of-sequence address ranges that cover a single house number. For example, address 709 Main Street is in the middle of the even-side of the 700 block of Main Street and will be suppressed because it is a single address-address range. The following address ranges for the 700 block of Main Street will appear in the 2015 TIGER/Line Shapefiles: 700-798 Main Street, 701-707 Main Street, and 711- 799 Main Street. Based on the information provided, data users cannot tell where 709 Main Street is located. Suppression of single address-address ranges is to protect the confidentiality of individual addresses as specified by Title 13 of the U.S. Code.
- Address ranges can include numbers with alphabetic characters. These characters help uniquely identify addresses within a county. For instance, certain unincorporated areas of Genesee County, Michigan, add a letter G prefix to the address number. The characters are consistently placed within the address range field; for example, the letter G maintains a consistent column placement in the range G1 to G99.
- Some address systems use a hyphen to separate avenue numbers, private road designators, and grid cell numbers from the structure numbers; for example, 10-01 Reynolds St. uses a hyphen to separate the avenue number (i.e. Tenth Avenue) from the structure number. Depending on the locality, the hyphen may be unnecessary for address matching.
- Address ranges exist only for street features, and in some cases, geographic corridor and geographic offset boundary features adjacent to street features. When these boundaries exist, the address ranges moved from the street centerline to the boundary to ensure that addresses will geocode to the correct entity.
- Address ranges (consisting of a unique combination of structure number, ZIP Code, feature name, feature type, and directional) should not overlap; addresses should belong to only one address range. The Census Bureau edits the address ranges to locate possible overlaps, but cannot guarantee that all possible overlap situations have been identified and resolved.
- Address ranges in the 2015 TIGER/Line Shapefiles may be associated with one or more of the street names that belong to an edge. Caution: Address range overlap conflicts may occur if the address ranges are associated with some street names or route numbers that were not intended

for use in locating addresses. A route number may traverse several streets with similar house numbers but different common names that are used for mail delivery.

Imputed Address Ranges

Imputed address ranges occur during the process of updating the MAF/TIGER database when a new edge intersects an existing edge with address ranges. The intersection splits the existing edge and produces two new edges connected by a new node located at the intersection point. The update program divides the old address ranges between the two new edges and imputes the address range ends at the new node.

The impute process allocates either all or part of each original address range to each of the new edges in proportion to their lengths (see Figures 6 and 7). For each side of the original edge, the process considers all address ranges appearing on the side and determines the overall low and high addresses. The process assumes the addresses are evenly distributed along the length of the edge and applies the proportion of edge lengths to the overall address range to calculate a split-point address for each side. Address ranges that fall entirely above or below the split-point address are moved intact to one of the new edges. The process divides any address ranges that contain the split-point address and allocates each part to one of the new edges. The new address range ends created from the split are imputed values and have the from address range type (FROMTYP) or to address range type (TOTYP) set to imputed value. Some intermediate address range ends also may carry the impute flag. These address range ends fall between the overall high and low address for edge sides that have more than one address range. In current practice, the imputation process will assign the entire address range to one of the edges if the other is very small and would receive only a single address using the proportional division of address ranges.

Geocoding

To get the best geocoding match results in ArcGIS, the Census Bureau advises data users to use the Address Range Feature Shapefile (ADDRFEAT.shp) to geo-reference/geocode addresses. Address ranges in the MAF/TIGER database may be separated into multiple address ranges on the same edge because of ZIP Code differences or to establish gaps created by address anomalies located elsewhere. Some address ranges may also include embedded alphanumeric characters or hyphens that make them distinct from the other address ranges on the same edge side. The ADDRFEAT.shp contains all of the address range to edge and street name relationships for a county to increase the number of potential geocoding matches. In comparison, the most inclusive address range in the All Line shapefile (EDGES.shp) can also be used for geocoding but a single pair of left- and right-side address ranges and the primary street name on the edge may not always provide complete address range coverage.

Limitations

Users of the address ranges in the 2015 TIGER/Line Shapefiles should be aware that address range overlaps, gaps, odd/even reversals, and low-high orientation reversals may exist in the data. With the exception of overlaps, these may be valid. While the Census Bureau continues to edit for and correct for data errors, it is possible that some still exist. The U.S. Census Bureau defines address ranges on a county-by-county basis. It is possible that a street crosses a county boundary may have overlapping address ranges. Checks are being implemented to identify and correct these issues. When using a geocoder, often the address range is returned as being located in the first county, alphabetically.

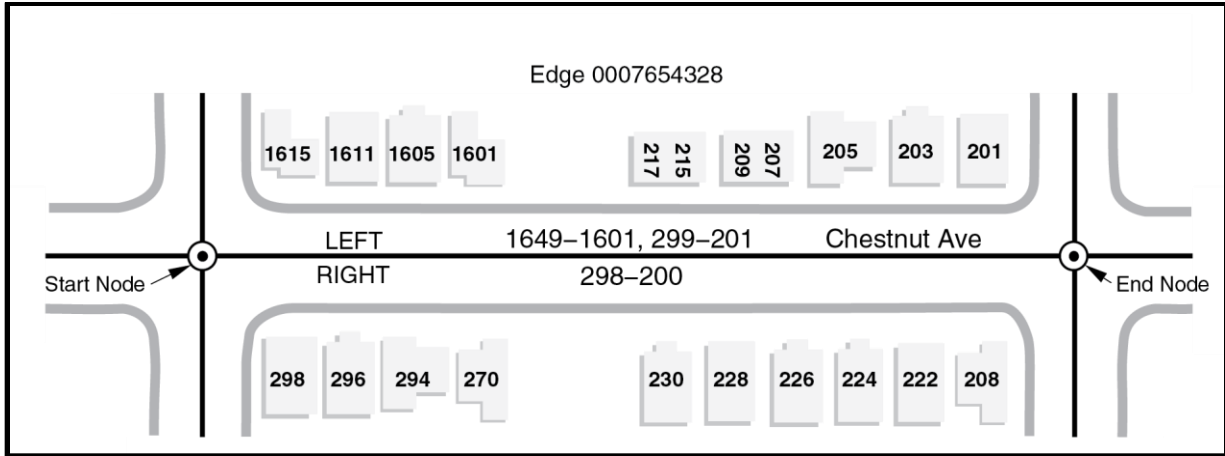

Figure 6: TIGER/Line Shapefile Address Range Imputes - Before Split

The MAF/TIGER database uses impute flags to indicate that the one or both ends of an address range are based on calculations rather than known values. Imputed address situations generally occur when an edge with existing address ranges becomes split by a new edge. The illustration above shows the address ranges on Chestnut Ave. before a split.

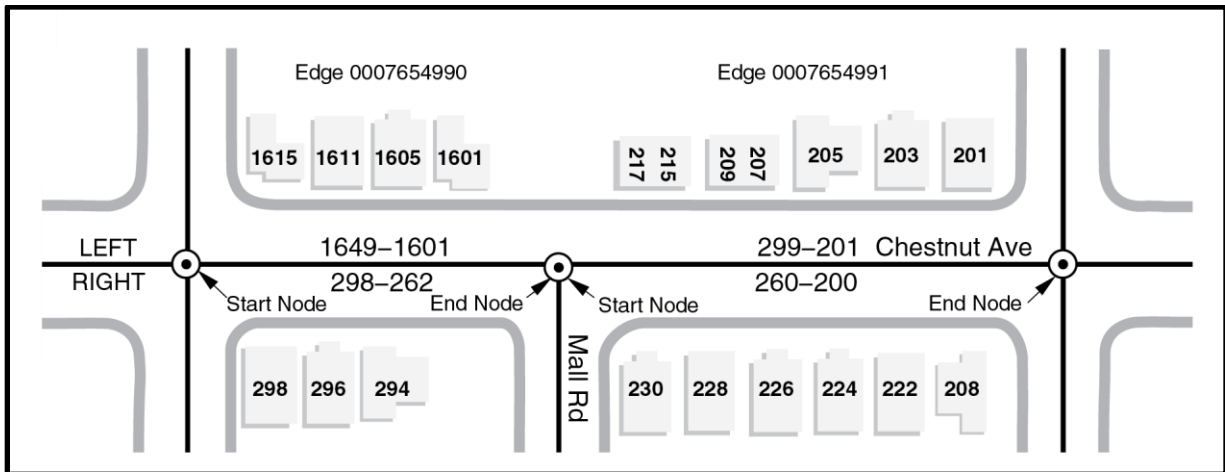

Figure 7: TIGER/Line Shapefile Address Range Imputes - After Split

In the diagram above, Mail Rd. has split the edge into two parts. Each part is assigned a new TIGER/Line identification number (TLID) and the old number is deleted. The overall address range for each edge side (1649 to 201 on the left side and 298 to 200 on the right side) and the split points for each of these address ranges (approximately 1088 on the left side and 261 of the right side) are determined by the MAF/TIGER database. Address ranges that fall entirely above or below the split point belong to one of the two new edges and do not get an impute flag. The MAF/TIGER database divides those address ranges that contain the split point and assigns a part to each of the edges.

4.1.1 Address Ranges County-based Relationship File Record Layout (Current)

File Name: tl_2015_<state-county FIPS>_addr.dbf

Field	Length	Type	Description
TLID	10	Integer	permanent edge ID
FROMHN	12	String	From house number
TOHN	12	String	To house number
SIDE	1	String	side indicator flag
ZIP	5	String	5-digit ZIP code
PLUS4	4	String	ZIP+4 code
FROMTYP	1	String	From address range end type
TOTYP	1	String	To address range end type
ARID	22	String	Address range identifier
MTFCC	5	String	MAF/TIGER feature class code

4.2 Address Range-Feature Name Relationships

Address range-to-feature name relationship information is available in the following relationship file:

Address Range-Feature Name County-based Relationship File

The address range-feature name relationship file contains a record for each address range-linear feature name relationship. The purpose of this relationship file is to identify all street names associated with each address range. An edge can have several feature names and an address range located on an edge can be associated with multiple feature names. The address range is identified by the address range identifier (ARID) attribute, which can be used to link to the Address Ranges Relationship File. The linear feature name is identified by the linear feature identifier (LINEARID) attribute that relates the address range back to the Feature Names Relationship File.

4.2.1 Address Range-Feature Name County-based Relationship File Record Layout (Current)

File Name: tl_2015_<state-county FIPS>_addrfn.dbf

Field	Length	Type	Description
ARID	22	String	Address range identifier
LINEARID	22	String	Linear feature identifier

4.3 Feature Names

Feature name information is available in the following relationship file:

Feature Names County-based Relationship File

The Feature Names Relationship File contains a record for each feature name-edge combination and includes the feature name attributes. The edge to which a Feature Names Relationship File record applies can be determined by linking to the All Lines shapefile using the permanent edge identifier (TLID) attribute. Multiple Feature Names relationship table records can link to the same edge. For example, a road edge could link to U.S. Hwy 22 and Rathburn Road. The linear feature to which the feature name applies is identified by the linear feature identifier (LINEARID) attribute. Multiple feature names may exist for the same edge. Linear features are not included in the data set, but could be constructed using the All Lines shapefile and the relationship tables.

Note that the MTFCC in this relationship file refers to the specific MAF/TIGER feature class code associated with this linear feature and feature name. If the edge is both a road and a rail feature, the name associated with the rail feature will carry a rail feature MTFCC. If there are any address ranges on the edge, they apply only to the designated street features.

Appendices B, C, and D of this document include additional information about feature name components.

4.3.1 Feature Names County-based Relationship File Record Layout (Current)

File Name: tl_2015_<state-county FIPS>_featnames.dbf

Field	Length	Type	Description
TLID	10	Integer	permanent edge ID
FULLNAME	100	String	Concatenation of expanded text for prefix qualifier, prefix direction, prefix type, base name, suffix type, suffix direction, and suffix qualifier (as available) with a space between each expanded text field
NAME	100	String	Base name portion of the standardized name
PREDIRABRV	15	String	Prefix direction description component of the feature name
PRETYPABRV	50	String	Prefix type description component of the feature name
PREQUALABR	15	String	Prefix qualifier description component of the feature name
SUFDIRABRV	15	String	Suffix direction description component of the feature name
SUFTYPABRV	50	String	Suffix type description component of the feature name
SUFQUALABR	15	String	Suffix qualifier description component of the feature name

Field	Length	Type	Description
PREDIR	2	String	prefix direction code component of the feature name
PRETYP	3	String	prefix type code description component of the feature name
PREQUAL	2	String	prefix qualifier code component of the feature name
SUFDIR	2	String	suffix direction code component of the feature name
SUFTYP	3	String	suffix type code description component of the feature name
SUFQUAL	2	String	suffix qualifier code component of the feature name
LINEARID	22	String	Linear feature identifier
MTFCC	5	String	MAF/TIGER feature class code
PAFLAG	1	String	primary/alternate flag

4.4 Topological Faces-Area Landmark Relationships

Topological faces-to-area landmark relationship information is available in the following relationship file:

Topological Faces-Area Landmark State-based Relationship File

The Topological Faces-Area Landmark Relationship file contains a record for each face-area landmark relationship. The face to which a Topological Faces-Area Landmark Relationship File record applies can be determined by linking to the Topological Faces (Polygons with All Geocodes) Shapefile using the permanent face identifier (TFID) attribute. The area landmark to which a Topological Faces-Area Landmark relationship table record applies can be determined by linking to the Area Landmark shapefile using the area landmark identifier (AREAID) attribute. A face may be part of multiple area landmarks. An area landmark may consist of multiple faces.

4.4.1 Topological Faces-Area Landmark County-based Relationship File Record Layout (Current)

File Name: tl_2015_<state FIPS>_facesal.dbf

Field	Length	Type	Description
TFID	10	Integer	permanent face ID
AREAID	22	String	Area landmark identifier

4.5 Topological Faces-Area Hydrography Relationships

Topological faces-to-area hydrography relationship information is available in the following relationship file:

Topological Faces-Area Hydrography County-based Relationship File

The Topological Faces-Area Hydrography Relationship File contains a record for each face-area hydrography feature relationship. The face to which a Topological Faces-Area Hydrography Relationship File record applies can be determined by linking to the Topological Faces (Polygons with All Geocodes) using the permanent face identifier (TFID) attribute. The area hydrography feature to which a Topological Faces-Area Hydrography Relationship File record applies can be determined by linking to the Area Hydrography shapefile using the area hydrography identifier (HYDROID) attribute. A face may be part of multiple area water features. An area water feature may consist of multiple faces.

4.5.1 Topological Faces-Area Hydrography County-based Relationship File Record Layout (Current)

File Name: tl_2015_<state-county FIPS>_facesah.dbf

Field	Length	Type	Description
TFID	10	Integer	permanent face ID
HYDROID	22	String	Area hydrography identifier

4.6 Topological Faces-Military Installation Relationships

Topological faces-to-military installation relationship information is available in the following relationship file:

Topological Faces-Military Installation National Relationship File

The Topological Faces-Military Installation Relationship File contains a record for each face-military installation relationship. To find out more information about the face the military installation relates to, use the permanent face identifier (TFID) in the Topological Faces (Polygons with All Geocodes) Shapefile. To determine the military installation the record applies to use the area id (AREAID) attribute found in the Military Installations Shapefile. A military installation feature may consist of multiple faces.

4.6.1 Topological Faces-Military Installation National Relationship File Record Layout (Current)

File name: tl_2015_us_facesmil.dbf

Field	Length	Type	Description
TFID	10	Integer	Permanent face ID
AREAID	22	String	Area landmark identifier

5. Instructions for Downloading the TIGER/Line Shapefiles

5.1 Getting Started

There are four methods for downloading TIGER/Line Shapefiles from the U.S. Census Bureau:

- Website Interface
- Direct from FTP Site
- Connect via FTP Client
- Direct from Data.gov

To download the shapefiles you need an Internet Browser or an FTP client, as well as a utility that can unzip files. The files downloaded are zipped to save space and ensure you download all of the necessary files. Most systems have an unzipping utility built-in to the operation system. However, there are several free or low cost unzipping utilities such as WinZIP.

The examples below are from the 2013 version of the TIGER/Line Shapefiles but can be used for all recent TIGER/Line Shapefile versions.

5.2 Website Interface

The website interface download method requires the least amount of technical knowledge. Start at the U.S. Census Bureau's TIGER website:

<http://www.census.gov/geo/maps-data/data/tiger-line.html>

- Select the tab for the version of TIGER/Line Shapefiles (e.g. 2013).
- Click on Download.
- Choose Web interface. (see Figure 8 below)



Figure 8: Click the appropriate tab and then click on download to access the web interface

- Select the geographic entity from the drop down menu you would like to download (e.g. census tracts) and click Submit. (see Figure 9 below)
- Choose the state and click Download. (see Figure 9 below) For a county-based file, you also need to choose the county on the following screen.

- Save the file to your computer or open the zip file.
- Repeat as necessary.

2013 TIGER/Line® Shapefiles

Select the layer you are interested in from the dropdown menu and click 'submit' for a list of the available geographic areas.

Select a layer type

Census Tracts submit

Source: US Census Bureau, Geography Division

Census Tract

--Select a state-- Download

Figure 9: An example of the menus available in the web interface

5.3. Direct from FTP Site

Another option is to go directly to the Census Bureau's FTP site through a web browser. The address for the TIGER/Line Shapefiles is:

<ftp://ftp2.census.gov/geo/tiger/> or <http://www2.census.gov/geo/tiger/>

- Navigate to the version of the TIGER/Line Shapefiles to download (e.g. TIGER2013).
- Navigate to the geographic entity to download (e.g. TRACT). (see Figure 10 below) Refer to Table 7 for the shapefile naming convention.

```

Up to higher level directory

08/21/2013 12:00AM      228,662 2013-FolderNames-Defined.pdf
08/16/2013 12:00AM      Directory ADDR
08/16/2013 12:00AM      Directory ADDRFEAT
08/16/2013 12:00AM      Directory ADDRFN
08/16/2013 12:00AM      Directory AIANNH
08/16/2013 12:00AM      Directory AITS
08/16/2013 12:00AM      Directory ANRC
08/16/2013 12:00AM      Directory AREALM
08/16/2013 12:00AM      Directory AREAWATER
08/16/2013 12:00AM      Directory BG
08/16/2013 12:00AM      Directory CBSA
08/16/2013 12:00AM      Directory CD
08/16/2013 12:00AM      Directory CNECTA
08/16/2013 12:00AM      Directory COAST
08/16/2013 12:00AM      Directory CONCITY
08/16/2013 12:00AM      Directory COUNTY
08/16/2013 12:00AM      Directory COUSUB
08/16/2013 12:00AM      Directory CSA
08/16/2013 12:00AM      Directory EDGES
08/16/2013 12:00AM      Directory ELSD

Up to higher level directory

08/16/2013 12:00AM      399,459 tl\_2013\_01001\_areawater.zip
08/16/2013 12:00AM      1,758,860 tl\_2013\_01003\_areawater.zip
08/16/2013 12:00AM      76,706 tl\_2013\_01005\_areawater.zip
08/16/2013 12:00AM      360,168 tl\_2013\_01007\_areawater.zip
08/16/2013 12:00AM      171,116 tl\_2013\_01009\_areawater.zip
08/16/2013 12:00AM      362,782 tl\_2013\_01011\_areawater.zip
08/16/2013 12:00AM      24,374 tl\_2013\_01013\_areawater.zip
08/16/2013 12:00AM      447,254 tl\_2013\_01015\_areawater.zip
08/16/2013 12:00AM      101,218 tl\_2013\_01017\_areawater.zip
08/16/2013 12:00AM      132,365 tl\_2013\_01019\_areawater.zip
08/16/2013 12:00AM      358,821 tl\_2013\_01021\_areawater.zip

```

Figure 10: An example of the directory structure within the FTP site.

- Click on the shapefile name to download.
- If prompted, use “anonymous” for the user name and password.

Table 6: 2015 TIGER/Line Shapefile file name definitions

File Name	Shapefile/Relationship File
ADDR	Address Range Relationship File
ADDRFEAT	Address Range Feature
ADDRFN	Address Range-Feature Name Relationship
AIANNH	American Indian / Alaska Native / Native Hawaiian Areas
AITSN	American Indian Tribal Subdivision National

ANRC	Alaska Native Regional Corporation
AREALM	Area Landmark
AREAWATER	Area Hydrography
BG	Block Group
CBSA	Metropolitan Statistical Area / Micropolitan Statistical Area
CD	Congressional District
CNECTA	Combined New England City and Town Area
COASTLINE	Coastline
CONCITY	Consolidated City
COUNTY	County
COUSUB	County Subdivision
CSA	Combined Statistical Area
EDGES	All Lines
ELSD	Elementary School District
ESTATE	Estate
FACES	Topological Faces (Polygons with All Geocodes)
FACESAH	Topological Faces-Area Hydrography Relationship File
FACESAL	Topological Faces-Area Landmark Relationship File
FACESMIL	Topological Faces-Military Installation Relationship File
FEATNAMES	Feature Names Relationship File
LINEARWATER	Linear Hydrography
METDIV	Metropolitan Division
MIL	Military Installation
NECTA	New England City and Town Area
NECTADIV	New England City and Town Area Division
PLACE	Place
POINTLM	Point Landmark
PRIMARYROADS	Primary Roads
PRISECROADS	Primary and Secondary Roads
PUMA	Public Use Microdata Area
RAILS	Rails
ROADS	All Roads
SCSD	Secondary School Districts
SLDL	State Legislative District – Lower Chamber
SLDU	State Legislative District – Upper Chamber
STATE	State and Equivalent
SUBBARRIO	SubMinor Civil Division (Subbarrios in Puerto Rico)
TABBLOCK	Tabulation (Census) Block
TBG	Tribal Block Group
TRACT	Census Tract
TTRACT	Tribal Census Tract
UAC	Urban Area/Urban Cluster
UNSD	Unified School District
ZCTA5	5-Digit ZIP Code Tabulation Area

The files are named tl_2015_<geographic area>_<filename>.zip. For national files, the geographic area is represented as “us.” For state and county-based files, the geographic area is represented with the state or county Federal Information Processing Series (FIPS) codes. The state codes are 2-character number and the county codes are 5-character numbers that include the 2-character state code and a 3-character county code. Lists of state and county FIPS codes can be found here:

<http://www.census.gov/geo/reference/ansi.html>.

Web browsers also have the option to display FTP pages in a “windows explorer” type format. Entire directories (folders) can be copied at a time using copy and paste or drag and drop.

5.4 Connect via FTP Client

To access a large number of files the best option is use an FTP client software to connect to the Census Bureau’s FTP site. There are many free FTP clients. The host name must be the Census Bureau’s main FTP site:

<ftp2.census.gov>.

Use “anonymous” for the user name and password. Then, navigate to the GEO, then TIGER folders.

5.5 Data.gov

The TIGER/Line Shapefiles are also available through the following website:

<http://www.data.gov/>

- Search by keyword and/or agency to find the individual shapefiles.

As new TIGER/Line Shapefiles become available, they will be added to Data.gov. Refer to Table 7 for the shapefile naming conventions.

6. Useful Links

6.1 User Notes

User notes contain additional information about a geographic entity's shapefile that is not available in this technical documentation. In addition, if errors are found in the TIGER/Line Shapefiles, such as duplicate records or missing attribute information, user notes are created to explain the errors and the corrections made.

User notes can be found from the main TIGER/Line Shapefile webpage:

<http://www.census.gov/geo/maps-data/data/tiger-line.html>.

User notes are unique to each release of TIGER/Line Shapefiles and can be found by clicking on the appropriate year's tab.

6.2 Help Documents

6.2.1 How to Guides

How to Guides provide a short overview on how to access and use the TIGER/Line Shapefiles, as well as joining data from the U.S. Census Bureau to the TIGER/Line Shapefiles. The guides are available here:

<http://www.census.gov/geo/education/howtos.html>.

6.2.2 Definitions

Additional information about each geographic entity, available as a TIGER/Line Shapefile, can be found in several formats. For basic definitions, visit the Geographic Terms and Concepts page:

<http://www.census.gov/geo/reference/terms.html>.

This site provides definitions of geographic terms and concepts for geographic entities found in the TIGER/Line Shapefiles and other U.S. Census Bureau data products.

For more in depth information, blog posts and brochures offer a more detailed look at some of the geographic entities available in shapefile format. Blog posts can be found here:

<http://www.census.gov/geo/education/blogs.html>.

Brochures can be found here:

<http://www.census.gov/geo/education/brochures.html>.

For specific information about each state's geographic entities, history, rankings, and more, you can read the Guide to State and Local Census Geography pages here:

<http://www.census.gov/geo/reference/geoguide.html>.

The definitions for several of the codes found in the attributes of the TIGER/Line Shapefiles can be found at the following links:

MAF/TIGER Feature Classifications Codes (MTFCC):

<http://www.census.gov/geo/reference/mtfcc.html>

Legal/Statistical Area Description (LSAD) Codes:

<http://www.census.gov/geo/reference/lсад.html>

Class (CLASSFP) Codes:

<http://www.census.gov/geo/reference/class.html>

Functional Status (FUNCSTAT) Codes:

<http://www.census.gov/geo/reference/funcstat.html>

Route Type (RTTYP) Codes:

<http://www.census.gov/geo/reference/rttp.html>

6.3 Additional TIGER Products for use in a GIS

6.3.1 TIGER Geodatabases

TIGER Geodatabases are spatial extracts from the U.S. Census Bureau's MAF/TIGER database for use with Esri's ArcGIS. The geodatabases contain both national and state coverage for boundaries and features. These files provide a way for data users to access larger amounts of geographic data with one download, however, the files are large. Technical documentation for the TIGER Geodatabases is available. These files are available here:

<http://www.census.gov/geo/maps-data/data/tiger-geodatabases.html>.

6.3.2 TIGER/Line Shapefiles and Geodatabases with Demographic Data

A limited set of TIGER/Line Shapefiles and TIGER Geodatabases are available with demographic data, including the 2010 Census and the American Community Survey. These files attempt to make GIS analysis and thematic mapmaking easier because they provide the data user with the geography and demographic data in one download. Each file also contains a metadata file to provide additional information about the demographic data included. Access these files here:

<http://www.census.gov/geo/maps-data/data/tiger-data.html>.

6.3.3 Cartographic Boundary Files

The cartographic boundary files are simplified representations of selected geographic areas from the Census Bureau's MAF/TIGER database. These boundary files are specifically designed for small-scale, thematic mapping. In addition, these generalized files are clipped to the shoreline to show a simplified version of the U.S. outline. Cartographic boundary files are available in shapefile format for the 2010 Census, Census 2000, and selected geographies for other years. In addition, they are available in shapefile and KML format beginning in 2013 and updates will be released annually one year after their corresponding TIGER/Line Shapefile release. KML stands for keyhole markup language and is a file format used to display geographic data in a tool such as Google Earth and Google Maps. The cartographic boundary files have less attribute information than the TIGER/Line Shapefiles and are not available for all the same geographic entities as the TIGER/Line Shapefiles. They can be downloaded from the following webpage:

<http://www.census.gov/geo/maps-data/data/tiger-cart-boundary.html>.

Appendix A. Pseudo-School Districts

2013 – 2014 School District Review Program Pseudo-School Districts (stored as Secondary School Districts)

Column headers:

STATEFP15 2015 ACS state FIPS code
 SDLEA15 2015 ACS secondary school district local education agency code
 NAME15 2015 ACS secondary school district name

STATEFP15	SDLEA15	NAME15
06	06001	Yosemite Unified School District in Bass Lake
06	06002	Yosemite Unified School District in Raymond-Knowles
06	06003	Twin Rivers Unified School District in Elverta
06	06004	Twin Rivers Unified School District in Robla
06	06005	Scott Valley Unified School District in Forks of Salmon
06	06006	Trinity Alps Unified School District in Burnt Ranch
06	06007	Trinity Alps Unified School District in Coffee Creek
06	06008	Trinity Alps Unified School District in Cox Bar
06	06009	Trinity Alps Unified School District in Douglas City
06	06010	Trinity Alps Unified School District in Junction City
06	06011	Trinity Alps Unified School District in Lewiston
06	06012	Trinity Alps Unified School District in Trinity Center
06	06013	Turlock Unified School District in Chatom Union
06	06014	Turlock Unified School District in Keyes Union
06	06015	Santa Cruz City High School District (9-12) in Soquel
06	06016	Dinuba Unified (9-12) in Kings River Union
06	06017	Dinuba Unified (9-12) in Monson-Sultana Joint Union
06	06018	Washington Unified School District (9-12)
06	06019	Santa Barbara Unified School District (7-12)
06	06020	Lammersville Joint Unified School District (9-12)

06	06021	Bishop Unified School District in Round Valley (9-12)
06	06022	Santa Paula Unified (9-12) in Briggs
06	06023	Santa Paula Unified (9-12) in Mupu
06	06024	Santa Paula Unified (9-12) in Santa Clara
06	06025	Hamilton Unified School District in Capay (9-12)
06	06026	Woodlake Unified School District (9-12) in Stone Corral
06	06027	Woodlake Unified School District (9-12) in Three Rivers Union
06	06028	Exeter Unified School District (9-12) in Sequoia Union
06	06029	Exeter Unified School District (9-12) in Outside Creek
06	06031	Tracy Unified School District (9-12) in Banta
06	06032	Tracy Unified School District (9-12) in Jefferson
06	06033	Tracy Unified School District (9-12) in New Jerusalem
06	06037	Alhambra Unified (9-12) School District
06	06053	Gonzales Unified (9-12) School District
06	06107	Porterville Unified (9-12) School District
13	13053	Chattahoochee County for Fort Benning
13	13215	Muscogee County for Fort Benning
17	17901	Flanagan-Cornell District 74 in Cornell
17	17902	Flanagan-Cornell District 74 in Pontiac
17	17903	Flanagan-Cornell District 74 in Rooks Creek
21	21001	Laurel County School District for East Bernstadt ISD
21	21002	Pulaski County School District for Science Hill ISD
21	21003	Elizabethtown Independent School District for West Point ISD
21	21004	Jefferson County School District in Anchorage ISD
21	21005	Campbell County School District in Southgate ISD
25	22222	Mohawk Trail Regional School District in Hawley and Charlemont towns

25	25002	North Adams School District in Clarksburg (9-12)
25	25003	Gill-Montague School District in Erving (7-12)
25	25005	Swampscott School District in Nahant (7-12)
25	25006	Pittsfield School District in Richmond (9-12)
25	25007	Mohawk Trail School District in Rowe (7-12)
25	25008	Adams-Cheshire School District in Savoy (7-12)
25	25009	North Adams School District in Florida (9-12)
25	25010	Fairhaven/New Bedford School Districts in Acushnet (9-12)
25	25012	Nauset/Provincetown School Districts in Turo (7-12)
25	25013	Mount Greylock/New Lebanon (NY) School Districts in Hancock (7-12)
25	25014	North Adams School District in Monroe (9-12)
25	25015	Lee/Berkshire Hills in Farmington River Regional (7-12)
27	27001	Park Rapids Public School District in Pine Point (9-12)
40	40001	Secondary Coverage Area in White Oak Public Schools (9-12)
45	45013	Beaufort County School District within Beaufort Marine Corps Air Station
45	45079	Richland County School District 2 within Fort Jackson
47	47001	Anderson County School District in Clinton
47	47029	Cocke County School District in Newport
47	47031	Coffee County School District in Manchester
47	47033	Crockett County School District in Alamo
47	47034	Crockett County School District in Bells
47	47073	Hawkins County School District in Rogersville
47	47077	Henderson County School District in Lexington
47	47079	Henry County School District in Paris
47	47107	McMinn County School District in Athens
47	47108	McMinn County School District in Etowah

47	47123	Monroe County School District in Sweetwater
47	47143	Rhea County School District in Dayton
47	47149	Rutherford County School District in Murfreesboro
47	47187	Williamson County School District in Franklin
47	47189	Wilson County School District in Lebanon
48	48021	Elgin/Giddings Independent School Districts (9-12) in McDade
48	48143	Stephenville Independent School District (9-12) in Bluff Dale
48	48285	Hallettsville Independent School District (9-12) in Vysehrad
48	48449	Mount Pleasant Independent School District (9-12) in Winfield
50	50001	Harwood Union High School District 19 (9-12)
50	50002	Mount Anthony Union High School District 14 (7-12)
50	50003	Brattleboro Union High School District 6 (9-12)

Appendix B. Feature Name Directionals

Direction Code	Expanded Full Text	Directional Abbreviation	Spanish	Translation
11	North	N	-	-
12	South	S	-	-
13	East	E	-	-
14	West	W	-	-
15	Northeast	NE	-	-
16	Northwest	NW	-	-
17	Southeast	SE	-	-
18	Southwest	SW	-	-
19	Norte	N	Y	North
20	Sur	S	Y	South
21	Este	E	Y	East
22	Oeste	O	Y	West
23	Noreste	NE	Y	Northeast
24	Noroeste	NO	Y	Northwest
25	Sudeste	SE	Y	Southeast
26	Sudoeste	SO	Y	Southwest

Appendix C. Feature Name Qualifiers

Qualifier Code	Expanded Full Text	Display Name Abbreviation	Prefix Qualifier	Suffix Qualifier
11	Access	Acc	N	Y
12	Alternate	Alt	Y	Y
13	Business	Bus	Y	Y
14	Bypass	Byp	Y	Y
15	Connector	Con	N	Y
16	Extended	Exd	Y	Y
17	Extension	Exn	N	Y
18	Historic	Hst	Y	N
19	Loop	Lp	Y	Y
20	Old	Old	Y	N
21	Private	Pvt	Y	Y
22	Public	Pub	Y	Y
23	Scenic	Scn	N	Y
24	Spur	Spr	Y	Y
25	Ramp	Rmp	N	Y
26	Underpass	Unp	N	Y
27	Overpass	Ovp	N	Y

Appendix D. Feature Name Types

Type Code	Expanded Full Text	Display Name abbreviation	Spanish	Translation	Prefix Type	Suffix Type
103	Academy	Acdmy			Y	Y
104	Acueducto	Acueducto	Yes	Aqueduct	Y	N
105	Aeropuerto	Aero	Yes	Airport	Y	N
106	Air Force Base	AFB			N	Y
107	Airfield	Airfield			N	Y
108	Airpark	Airpark			N	Y
109	Airport	Arprt			N	Y
110	Airstrip	Airstrip			N	Y
112	Alley	Aly			N	Y
115	Apartment Building	Apt Bldg			N	Y
116	Apartment Complex	Apt Complex			N	Y
117	Apartments	Apts			N	Y
118	Aqueduct	Aqueduct			N	Y
119	Arcade	Arc			Y	Y
121	Arroyo	Arroyo	Yes	Stream	Y	N
122	Assisted Living Center	Asstd Liv Ctr			N	Y
694	Assisted Living Facility	Asstd Liv Fac			N	Y
123	Autopista	Autopista	Yes	Expressway/Freeway	Y	N
124	Avenida	Ave	Yes	Avenue	Y	N
125	Avenue	Ave			Y	Y

Type Code	Expanded Full Text	Display Name abbreviation	Spanish	Translation	Prefix Type	Suffix Type
126	Bahia	Bahía	Yes	Bay	Y	N
127	Bank	Bk			Y	Y
704	Base	Base			N	Y
128	Basin	Basin			N	Y
129	Bay	Bay			Y	Y
130	Bayou	Byu			Y	Y
131	Beach	Bch			N	Y
132	Bed and Breakfast	B and B			N	Y
136	Beltway	Beltway			N	Y
137	Bend	Bnd			N	Y
138	Bluff	Blf			N	Y
139	Boarding House	Brdng Hse			N	Y
140	Bog	Bog			N	Y
141	Bosque	Bosque	Yes	Forest	Y	N
142	Boulevard	Blvd			Y	Y
143	Boundary	Boundary			N	Y
146	Branch	Br			Y	Y
147	Bridge	Brg			N	Y
148	Brook	Brk			N	Y
149	Building	Bldg			Y	Y
150	Bulevar	Bulevar	Yes	Boulevard	Y	N
151	Bureau of Indian Affairs Highway	BIA Hwy			Y	N
152	Bureau of Indian Affairs Road	BIA Rd			Y	N
153	Bureau of Indian Affairs Route	BIA Rte			Y	N
154	Bureau of Land Management Road	BLM Rd			Y	N
696	Bypass	Byp			Y	Y
156	Calle	Cll	Yes	Street	Y	N
157	Calleja	Calleja	Yes	Narrow Street	Y	N

Type Code	Expanded Full Text	Display Name abbreviation	Spanish	Translation	Prefix Type	Suffix Type
158	Callejón	Callejón	Yes	Alley	Y	N
159	Caminito	Cmt	Yes	Little Road	Y	N
160	Camino	Cam	Yes	Road/Way	Y	N
161	Camp	Cp			Y	Y
163	Campground	Cmpgrnd			N	Y
164	Campus	Cmps			N	Y
165	Canal	Cnl			Y	Y
172	Cano	Caño	Yes	Drain/Sewer	Y	N
166	Cantera	Cantera	Yes	Quarry/Gravel Pit	Y	N
167	Canyon	Cyn			Y	Y
168	Capilla	Capilla	Yes	Chapel	Y	N
169	Carretera	Carr	Yes	Road	Y	N
170	Causeway	Cswy			N	Y
171	Cayo	Cayo	Yes	Key	Y	N
173	Cementerio	Cem	Yes	Cemetery	Y	N
174	Cemetery	Cmtry			N	Y
175	Center	Ctr			Y	Y
176	Centro	Centro	Yes	Center	Y	N
177	Cerrada	Cer	Yes	Closed	Y	N
178	Chamber of Commerce	Cham of Com			N	Y
179	Channel	Chnnl			N	Y
180	Chapel	Cpl			Y	Y
181	Childrens Home	Childrens Home			N	Y
182	Church	Church			Y	Y
183	Circle	Cir			N	Y
234	Círculo	Cir	Yes	Circle	Y	N
184	City Hall	City Hall			N	Y
185	City Park	City Park			N	Y

Type Code	Expanded Full Text	Display Name abbreviation	Spanish	Translation	Prefix Type	Suffix Type
186	Cliff	Clf			N	Y
187	Club	Clb			Y	Y
188	Colegio	Colegio	Yes	School	Y	N
189	College	Colg			Y	Y
190	Common	Cmn			N	Y
191	Commons	Cmns			Y	Y
192	Community Center	Community Ctr			N	Y
193	Community College	Community Colg			Y	Y
194	Community Park	Community Park			Y	Y
195	Complex	Complx			N	Y
197	Condominios	Condios	Yes	Condominiums	Y	N
198	Condominium	Condo			Y	Y
199	Condominiums	Condos			N	Y
201	Convent	Cnvnt			Y	Y
202	Convention Center	Convention Ctr			Y	Y
203	Corners	Cors			N	Y
204	Correctional Facility	Corr Facly			N	Y
205	Correctional Institute	Corr Inst			N	Y
207	Corte	Corte	Yes	Court	Y	N
679	Cottage	Cottage			N	Y
208	Coulee	Coulee			N	Y
209	Country Club	Country Club			Y	Y
210	County Highway	Co Hwy			Y	N
211	County Home	Co Home			Y	Y
212	County Lane	Co Ln			Y	N
213	County Park	Co Park			N	Y
214	County Road	Co Rd			Y	N
215	County Route	Co Rte			Y	N

Type Code	Expanded Full Text	Display Name abbreviation	Spanish	Translation	Prefix Type	Suffix Type
216	County State Aid Highway	Co St Aid Hwy			Y	N
217	County Trunk Highway	Co Trunk Hwy			Y	N
218	County Trunk Road	Co Trunk Rd			Y	N
219	Course	Crs			N	Y
220	Court	Ct			Y	Y
221	Courthouse	Courthouse			N	Y
222	Courts	Cts			N	Y
223	Cove	Cv			N	Y
225	Creek	Crk			N	Y
226	Crescent	Cres			N	Y
227	Crest	Crst			N	Y
228	Crossing	Xing			N	Y
229	Crossroads	Xroad			Y	Y
233	Cutoff	Cutoff			N	Y
235	Dam	Dm			N	Y
236	Delta Road	Delta Rd			Y	N
237	Department	Dept			Y	Y
238	Depot	Dep			N	Y
239	Detention Center	Detention Ctr			N	Y
240	District of Columbia Highway	DC Hwy			Y	N
241	Ditch	Ditch			Y	Y
242	Divide	Dv			N	Y
243	Dock	Dock			N	Y
244	Dormitory	Dormitory			N	Y
245	Drain	Drn			N	Y
246	Draw	Draw			N	Y
247	Drive	Dr			N	Y
248	Driveway	Driveway			Y	Y

Type Code	Expanded Full Text	Display Name abbreviation	Spanish	Translation	Prefix Type	Suffix Type
249	Dump	Dump			N	Y
251	Edificio	Edif	Yes	Building	Y	N
252	Elementary School	Elem School			N	Y
253	Ensenada	Ensenada	Yes	Cove	Y	N
254	Entrada	Ent	Yes	Entrance	Y	N
256	Escuela	Escuela	Yes	School	Y	N
680	Esplanade	Esplanade	Yes	Esplanade	Y	Y
257	Estates	Ests			N	Y
260	Estuary	Estuary			N	Y
261	Expreso	Expreso	Yes	Expressway	Y	N
262	Expressway	Epy			Y	Y
263	Extension	Ext			Y	Y
264	Facility	Facilty			N	Y
265	Fairgrounds	Fairgrounds			N	Y
266	Falls	FIs			Y	Y
267	Farm	Frm			N	Y
268	Farm Road	Farm Rd			Y	N
269	Farm-to-Market Road	FM			Y	N
275	Fence Line	Fence Line			N	Y
276	Ferry Crossing	Ferry Crossing			Y	Y
277	Field	Fld			N	Y
278	Fire Control Road	Fire Cntrl Rd			Y	N
279	Fire Department	Fire Dept			N	Y
280	Fire District Road	Fire Dist Rd			Y	N
281	Fire Lane	Fire Ln			Y	N
282	Fire Road	Fire Rd			Y	N
283	Fire Route	Fire Rte			Y	N
284	Fire Station	Fire Sta			Y	Y

Type Code	Expanded Full Text	Display Name abbreviation	Spanish	Translation	Prefix Type	Suffix Type
285	Fire Trail	Fire Trl			Y	N
286	Flowage	Flowage			N	Y
287	Flume	Flume			N	Y
288	Forest	Frst			N	Y
289	Forest Highway	Forest Hwy			Y	Y
290	Forest Road	Forest Rd			Y	N
291	Forest Route	Forest Rte			Y	N
292	Forest Service Road	FS Rd			Y	N
293	Fork	Frk			N	Y
294	Fort	Ft			Y	N
295	Four-Wheel Drive Trail	4WD Trl			Y	Y
296	Fraternity	Frtrnty			N	Y
297	Freeway	Fwy			N	Y
298	Garage	Grge			N	Y
299	Gardens	Gdns			N	Y
303	Glacier	Glacier			N	Y
304	Glen	Gln			N	Y
305	Golf Club	Golf Club			Y	Y
306	Golf Course	Golf Course			Y	Y
307	Grade	Grade			N	Y
309	Green	Grn			N	Y
310	Group Home	Group Home			N	Y
311	Gulch	Gulch			N	Y
312	Gulf	Gulf			Y	Y
313	Gully	Gully			N	Y
314	Halfway House	Halfway House			N	Y
315	Hall	Hall			N	Y
316	Harbor	Hbr			N	Y

Type Code	Expanded Full Text	Display Name abbreviation	Spanish	Translation	Prefix Type	Suffix Type
317	Heights	Hts			N	Y
321	High School	High School			N	Y
322	Highway	Hwy			Y	Y
323	Hill	Hl			N	Y
324	Hollow	Holw			N	Y
325	Home	Home			Y	Y
326	Hospital	Hosp			Y	Y
327	Hostel	Hostel			N	Y
328	Hotel	Hotel			Y	Y
329	House	Hse			Y	Y
330	Housing	Hsng			Y	Y
332	Iglesia	Iglesia	Yes	Church	Y	N
333	Indian Route	Indian Rte			Y	N
334	Indian Service Route	Indian Svc Rte			Y	N
336	Industrial Park	Indl Park			N	Y
337	Inlet	Inlt			N	Y
338	Inn	Inn			Y	Y
339	Institute	Inst			Y	Y
340	Institution	Instn			N	Y
341	Instituto	Instituto	Yes	Institute	Y	N
342	Intermediate School	Inter School			N	Y
344	Interstate Highway	I-			Y	N
345	Isla	Isla	Yes	Island	Y	N
346	Island	Is			N	Y
347	Islands	Iss			Y	Y
348	Isle	Isle			Y	Y
349	Jail	Jail			N	Y
351	Jeep Trail	Jeep Trl			Y	Y

Type Code	Expanded Full Text	Display Name abbreviation	Spanish	Translation	Prefix Type	Suffix Type
352	Junction	Junction			N	Y
353	Junior High School	Jr HS			N	Y
356	Kill	Kill			Y	Y
357	Lago	Lago	Yes	Lake	Y	N
358	Lagoon	Lagoon			N	Y
360	Laguna	Laguna	Yes	Lagoon	Y	N
361	Lake	Lk			Y	Y
362	Lakes	Lks			N	Y
363	Landfill	Lndfill			N	Y
364	Landing	Lndg			N	Y
365	Landing Area	Landing Area			Y	Y
366	Landing Field	Landing Fld			Y	Y
367	Landing Strip	Landing Strp			Y	Y
368	Lane	Ln			Y	Y
369	Lateral	Lateral			Y	Y
370	Levee	Levee			Y	Y
371	Library	Lbry			Y	Y
372	Lift	Lift			Y	Y
373	Lighthouse	Lighthouse			N	Y
374	Line	Line			Y	Y
376	Lodge	Ldg			N	Y
377	Logging Road	Logging Rd			Y	Y
378	Loop	Loop			Y	Y
379	Mall	Mall			Y	Y
380	Manor	Mnr			N	Y
381	Mar	Mar	Yes	Sea	Y	N
382	Marginal	Marginal	Yes	Service Road	Y	N
383	Marina	Mrna			N	Y

Type Code	Expanded Full Text	Display Name abbreviation	Spanish	Translation	Prefix Type	Suffix Type
384	Marsh	Marsh			N	Y
385	Meadows	Mdws			N	Y
386	Medical Building	Medical Bldg			N	Y
387	Medical Center	Medical Ctr			Y	Y
388	Memorial	Meml			N	Y
389	Memorial Gardens	Memorial Gnds			N	Y
390	Memorial Park	Memorial Pk			N	Y
391	Mesa	Mesa			Y	Y
392	Middle School	Mid Schl			N	Y
393	Military Reservation	Mil Res			N	Y
394	Millpond	Millpond			N	Y
395	Mine	Mine			N	Y
396	Mission	Mssn			Y	Y
397	Mobile Home Community	Mobile Hm Cmty			Y	Y
398	Mobile Home Estates	Mobile Hm Est			Y	Y
399	Mobile Home Park	Mobile Hm Pk			Y	Y
400	Monastery	Monstry			Y	Y
401	Monument	Mnmt			N	Y
403	Mosque	Mosque			Y	Y
404	Motel	Mtl			Y	Y
405	Motor Lodge	Motor Lodge			N	Y
406	Motorway	Mtwy			N	Y
407	Mount	Mt			Y	Y
408	Mountain	Mtn			N	Y
411	Museum	Mus			Y	Y
412	National Battlefield	Natl Bfld			N	Y
413	National Battlefield Park	Natl Bfld Pk			N	Y
414	National Battlefield Site	Natl Bfld Site			N	Y

Type Code	Expanded Full Text	Display Name abbreviation	Spanish	Translation	Prefix Type	Suffix Type
415	National Conservation Area	Natl Cnsv Area			N	Y
416	National Forest	Natl Forest			N	Y
417	National Forest Development Road	Nat For Dev Rd			Y	N
419	National Grasslands	Natl Grsslnds			N	Y
420	National Historic Site	Natl Hist Site			N	Y
421	National Historical Park	Natl Hist Pk			N	Y
422	National Lakeshore	Natl Lkshr			N	Y
423	National Memorial	Natl Meml			N	Y
424	National Military Park	Natl Mil Pk			N	Y
425	National Monument	Natl Mnmt			N	Y
426	National Park	Natl Pk			N	Y
427	National Preserve	Natl Prsv			N	Y
428	National Recreation Area	Natl Rec Area			N	Y
429	National Recreational River	Natl Rec Riv			N	Y
430	National Reserve	Natl Resv			N	Y
431	National River	Natl Riv			N	Y
432	National Scenic Area	Natl Sc Area			N	Y
433	National Scenic River	Natl Sc Riv			N	Y
435	National Scenic Riverways	Natl Sc Rvrwys			N	Y
436	National Scenic Trail	Natl Sc Trl			N	Y
437	National Seashore	Natl Shr			N	Y
438	National Wildlife Refuge	Natl Wld Rfg			N	Y
439	Navajo Service Route	Navajo Svc Rte			Y	N
440	Naval Air Station	Naval Air Sta			N	Y
442	Nursing Home	Nurse Home			N	Y
444	Ocean	Ocean			N	Y
445	Oceano	Océano	Yes	Ocean	Y	N
446	Office	Ofc			Y	Y

Type Code	Expanded Full Text	Display Name abbreviation	Spanish	Translation	Prefix Type	Suffix Type
447	Office Building	Office Bldg			N	Y
449	Office Park	Office Park			N	Y
698	Orchard	Orchard			N	Y
451	Orchards	Orchrds			N	Y
452	Orphanage	Orphanage			N	Y
453	Outlet	Outlet			N	Y
454	Oval	Oval			N	Y
455	Overpass	Opas			N	Y
456	Parish Road	Parish Rd			Y	N
457	Park	Park			N	Y
458	Park and Ride	Park and Ride			N	Y
460	Parkway	Pkwy			N	Y
706	Parq	Parq	Yes	Park	Y	N
461	Parque	Parque	Yes	Park	Y	N
462	Pasaje	Pasaje	Yes	Passage	Y	N
463	Paseo	Pso	Yes	Path	Y	N
464	Pass	Pass			Y	Y
465	Passage	Psgge			Y	Y
466	Path	Path			N	Y
682	Pavilion	Pavilion			N	Y
467	Peak	Peak			N	Y
705	Penitentiary	Penitentiary			N	Y
468	Pier	Pier			Y	Y
469	Pike	Pike			N	Y
470	Pipeline	Pipeline			N	Y
472	Place	Pl			N	Y
473	Placita	Pla	Yes	Little Plaza	Y	N
474	Plant	Plnt			N	Y

Type Code	Expanded Full Text	Display Name abbreviation	Spanish	Translation	Prefix Type	Suffix Type
683	Plantation	Plantation			N	Y
475	Playa	Playa	Yes	Beach	Y	N
476	Playground	Playground			N	Y
477	Plaza	Plz			Y	Y
478	Point	Pt			Y	Y
479	Pointe	Pointe			N	Y
480	Police Department	Police Dept			Y	Y
481	Police Station	Police Station			Y	Y
482	Pond	Pond			Y	Y
483	Ponds	Ponds			N	Y
485	Port	Prt			Y	Y
486	Post Office	Post Office			N	Y
487	Power Line	Power Line			N	Y
691	Power Plant	Power Plant			N	Y
488	Prairie	Pr			N	Y
489	Preserve	Preserve			N	Y
491	Prison	Prison			N	Y
690	Prison Farm	Prison Farm			N	Y
685	Promenade	Promenade			N	Y
492	Prong	Prong			N	Y
494	Puente	Puente	Yes	Bridge	Y	N
495	Quadrangle	Quadrangle			N	Y
496	Quarry	Quar			N	Y
686	Quarters	Quarters			N	Y
497	Quebrada	Qbda	Yes	Creek	Y	N
499	Race	Race			N	Y
501	Rail	Rail			N	Y
502	Rail Link	Rail Link			Y	Y

Type Code	Expanded Full Text	Display Name abbreviation	Spanish	Translation	Prefix Type	Suffix Type
504	Railnet	Railnet			N	Y
505	Railroad	RR			N	Y
506	Railway	Rlwy			N	Y
507	Ramal	Ramal	Yes	Short Street	Y	N
508	Ramp	Ramp			N	Y
510	Ranch Road	Ranch Rd			Y	N
511	Ranch to Market Road	RM			Y	N
512	Rancho	Rch	Yes	Ranch/Farm	Y	N
513	Ravine	Ravine			N	Y
514	Recreation Area	Rec Area			N	Y
515	Reformatory	Reformatory			N	Y
516	Refuge	Refuge			N	Y
518	Regional Park	Regional Pk			N	Y
519	Reservation	Reservation			N	Y
520	Reservation Highway	Resvn Hwy			Y	N
521	Reserve	Resv			N	Y
522	Reservoir	Reservoir			Y	Y
524	Residence Hall	Res Hall			N	Y
525	Residencial	Residencial	Yes	Public Housing Project	Y	N
526	Resort	Resrt			N	Y
688	Rest Home	Rest Home			N	Y
527	Retirement Home	Retirement Hme			N	Y
528	Retirement Village	Retirement Vlg			N	Y
529	Ridge	Rdg			N	Y
543	Rio	Río	Yes	River	Y	N
530	River	Riv			N	Y
531	Road	Rd			Y	Y
533	Roadway	Roadway			N	Y

Type Code	Expanded Full Text	Display Name abbreviation	Spanish	Translation	Prefix Type	Suffix Type
535	Rock	Rock			Y	Y
536	Rooming House	Rooming Hse			N	Y
537	Route	Rte			Y	Y
538	Row	Row			Y	Y
539	Rue	Rue			Y	Y
540	Run	Run			N	Y
541	Runway	Runway			Y	Y
542	Ruta	Ruta	Yes	Route	Y	N
498	RV Park	RV Park			N	Y
545	Sanitarium	Sanitarium			N	Y
546	School	Schl			Y	Y
549	Sea	Sea			Y	Y
550	Seashore	Seashore			N	Y
552	Sector	Sec	Yes	Sector	Y	N
553	Seminary	Smry			Y	Y
554	Sendero	Sendero	Yes	Foot Path	Y	N
555	Service Road	Svc Rd			Y	Y
556	Shelter	Shelter			N	Y
558	Shop	Shop			N	Y
699	Shopping Center	Shopping Ctr			N	Y
560	Shopping Mall	Shopping Mall			N	Y
700	Shopping Plaza	Shopping Plz			N	Y
703	Site	Site			N	Y
564	Skyway	Skwy			Y	Y
565	Slough	Slough			N	Y
566	Sonda	Sonda	Yes	Sound	Y	N
567	Sorority	Sorority			Y	Y
568	Sound	Snd			Y	N

Type Code	Expanded Full Text	Display Name abbreviation	Spanish	Translation	Prefix Type	Suffix Type
569	Spa	Spa			Y	Y
570	Speedway	Speedway			Y	Y
571	Spring	Spg			N	Y
572	Spur	Spur			Y	Y
573	Square	Sq			Y	Y
575	State Beach	State Beach			N	Y
577	State Forest	State Forest			N	Y
578	State Forest Service Road	St FS Rd			Y	N
579	State Highway	State Hwy			Y	N
580	State Hospital	State Hospital			Y	Y
581	State Loop	State Loop			Y	N
582	State Park	State Park			N	Y
584	State Prison	State Prison			N	Y
585	State Road	State Rd			Y	N
586	State Route	State Rte			Y	N
588	State Spur	State Spur			Y	N
589	State Trunk Highway	St Trunk Hwy			Y	N
591	Station	Sta			N	Y
592	Strait	Strait			Y	Y
593	Stravenue	Stra			N	Y
594	Stream	Strm			N	Y
595	Street	St			N	Y
596	Strip	Strip			Y	Y
599	Swamp	Swamp			N	Y
600	Synagogue	Synagogue			Y	Y
601	Tank	Tank			N	Y
603	Temple	Tmpl			Y	Y
604	Terminal	Trmnl			N	Y

Type Code	Expanded Full Text	Display Name abbreviation	Spanish	Translation	Prefix Type	Suffix Type
605	Terrace	Ter			Y	Y
687	Thoroughfare	Thoroughfare			N	Y
607	Toll Booth	Toll Booth			Y	Y
701	Toll Road	Toll Rd			N	Y
610	Tollway	Tollway			N	Y
611	Tower	Twr			Y	Y
612	Town Center	Town Ctr			Y	Y
613	Town Hall	Town Hall			N	Y
614	Town Highway	Town Hwy			Y	N
615	Town Road	Town Rd			Y	N
616	Towne Center	Towne Ctr			Y	Y
617	Township Highway	Twp Hwy			Y	N
618	Township Road	Twp Rd			Y	N
619	Trace	Trce			N	Y
620	Track	Trak			Y	Y
621	Trafficway	Trfy			N	Y
622	Trail	Trl			Y	Y
623	Trailer Court	Trailer Ct			N	Y
624	Trailer Park	Trailer Pk			N	Y
628	Transmission Line	Trans Ln			N	Y
702	Treatment Plant	Trmt Plant			Y	Y
630	Tribal Road	Tribal Rd			Y	N
632	Trolley	Trolley			Y	Y
633	Truck Trail	Truck Trl			Y	Y
636	Túnel	Túnel	Yes	Tunnel	Y	N
634	Tunnel	Tunl			Y	Y
635	Turnpike	Tpke			N	Y
637	Underpass	Upas			Y	Y

Type Code	Expanded Full Text	Display Name abbreviation	Spanish	Translation	Prefix Type	Suffix Type
642	Universidad	Universidad	Yes	University/College	Y	N
643	University	Univ			Y	Y
638	US Forest Service Highway	USFS Hwy			Y	N
639	US Forest Service Road	USFS Rd			Y	N
640	US Highway	US Hwy			Y	N
641	US Route	US Rte			Y	N
644	Valley	Vly			N	Y
645	Vereda	Ver	Yes	Path	Y	N
655	Via	Via	Yes	Way	Y	N
646	Viaduct	Viaduct			N	Y
647	View	Vw			N	Y
648	Villa	Villa			Y	Y
649	Village	Vlg			Y	Y
650	Village Center	Village Ctr			Y	Y
697	Vineyard	Vineyard			N	Y
652	Vineyards	Vineyards			N	Y
654	Vista	Vis	Yes	View	Y	Y
656	Walk	Walk			N	Y
657	Walkway	Walkway			N	Y
659	Wash	Wash			N	Y
660	Waterway	Waterway			N	Y
661	Way	Way			N	Y
663	Wharf	Wharf			N	Y
665	Wild and Scenic River	Wld n Snc Riv			N	Y
664	Wild River	Wild River			N	Y
666	Wilderness	Wilderness			N	Y
667	Wilderness Park	Wilderenss Pk			N	Y
668	Wildlife Management Area	Wldlf Mgt Area			N	Y

Type Code	Expanded Full Text	Display Name abbreviation	Spanish	Translation	Prefix Type	Suffix Type
669	Winery	Winery			Y	Y
672	Yard	Yard			N	Y
673	Yards	Yards			Y	Y
670	YMCA	YMCA			Y	Y
671	YWCA	YWCA			Y	Y
675	Zanja	Zanja	Yes	Ditch	Y	N
676	Zoo	Zoo			Y	Y