

TIGER/Line® Shapefiles

2020

Technical Documentation



SUGGESTED CITATION

FILES:
2020 TIGER/Line Shapefiles (machine-readable data files) / prepared by the U.S. Census Bureau, 2020

TECHNICAL DOCUMENTATION:
2020 TIGER/Line Shapefiles Technical Documentation / prepared by the U.S. Census Bureau, 2020



U.S. Department of Commerce

Wilbur Ross,
Secretary



Economic and Statistics Administration

Karen Dunn Kelley,
Under Secretary for Economic Affairs

U.S. Census Bureau

Steven Dillingham,
Director

Albert Fontenot,
Associate Director for Decennial Census Programs

Ron Jarmin,
Deputy Director and Chief Operating Officer

GEOGRAPHY DIVISION

Deirdre Dalpiaz Bishop,
Chief

Andrea G. Johnson,
Assistant Division Chief for Address and Spatial Data Updates

Monique Eleby,
Assistant Division Chief for Geographic Program Management and External Engagement

Laura Waggoner,
Assistant Division Chief for Geographic Data Collection and Products

Michael R. Ratcliffe,
Assistant Division Chief for Geographic Standards, Criteria, Research, and Quality

Gregory F. Hanks, Jr.,
Deputy Division Chief

Table of Contents

1.	Legal Disclaimer, Citation Information and Contact.....	1-1
1.1	TIGER/Line Shapefile Legal Disclaimers	1-1
1.2	Citation Information	1-1
1.3	Contact Information.....	1-1
2.	Introduction.....	2-2
2.1	What is a Shapefile?	2-2
2.2	What are TIGER/Line Shapefiles?.....	2-2
2.3	Relationship of the TIGER/Line Shapefiles to Census Statistical Data	2-2
2.4	History and Sources of TIGER/Line Files and Shapefiles.....	2-2
3.	About the 2020 TIGER/Line Shapefiles	3-4
3.1	What is in the 2020 TIGER/Line Shapefiles.....	3-4
3.2	File Changes and Updates for the 2020 TIGER/Line Shapefiles	3-8
3.2.1	List of files	3-8
3.2.2	Boundary Changes.....	3-8
3.3	Structure and Format	3-9
3.3.1	Structure	3-9
3.3.2	File Naming Conventions	3-9
3.3.3	Datum (GCS NAD 83)	3-10
3.3.4	Metadata	3-10
3.3.5	Spatial Accuracy of Linear Features	3-11
3.3.6	Coordinates.....	3-11
3.3.7	Codes for Geographic Entities.....	3-11
4.	Geographic Shapefile Concepts Overview	4-12
4.1	American Indian / Alaska Native / Native Hawaiian (AIANNH) Areas	4-12
4.1.1	Alaska Native Regional Corporations (ANRCs).....	4-12
4.1.2	American Indian/Alaska Native/Native Hawaiian (AIANNH) Areas	4-12
4.1.2.1	Legal Entity Definitions	4-13
4.1.2.2	Statistical Entity Definitions	4-14
4.1.3	American Indian Tribal Subdivisions.....	4-17
4.1.4	Tribal Census Tract.....	4-17
4.1.5	Tribal Block Group.....	4-18

4.2	Blocks (Census Block)	4-19
4.3	Block Groups	4-22
4.4	Census Tracts	4-22
4.5	Congressional Districts	4-24
4.6	Consolidated Cities	4-24
4.7	Counties and Equivalent Entities	4-25
4.8	County Subdivisions	4-26
4.9	Estates (United States Virgin Islands)	4-28
4.10	Hydrography (Area and Linear)	4-29
4.11	Landmarks (Area and Point)	4-29
4.12	Linear Features	4-30
4.12.1	All Lines	4-30
4.12.2	Coastline	4-31
4.12.3	Roads – Primary, Secondary and All Roads	4-31
4.12.4	Address Ranges	4-32
4.12.5	Railroads	4-32
4.13	Metropolitan and Micropolitan Statistical Areas and Related Statistical Areas	4-33
4.14	Military Installations	4-35
4.15	Places – Incorporated Places and Census Designated Places	4-36
4.16	Public Use Microdata Areas (PUMAs)	4-40
4.17	School Districts (Elementary, Secondary, and Unified)	4-40
4.18	States and State Equivalent Entities	4-42
4.19	State Legislative Districts (Upper and Lower)	4-43
4.20	Subbarrio (Subminor Civil Division) (Puerto Rico)	4-44
4.21	Topological Faces (Polygons with All Geocodes)	4-44
4.22	Urban Areas	4-45
4.23	ZIP Code Tabulation Areas (5-digit)	4-45
5.	Relationship File Concept Overview	5-46
5.1	Address Ranges	5-46
5.1.1	ZIP Codes and Address Ranges	5-47
5.1.2	Imputed Address Ranges	5-49
5.1.3	Geocoding	5-49
5.1.4	Limitations	5-50
5.2	Address Range-Feature Name Relationships	5-51
5.3	Feature Names	5-51
5.4	Topological Faces-Area Landmark Relationships	5-52
5.5	Topological Faces-Area Hydrography Relationships	5-52
5.6	Topological Faces-Military Installation Relationships	5-53
6.	Instructions for Downloading the TIGER/Line Shapefiles	6-54

6.1 Software requirements	6-54
6.2 Getting Started	6-54
6.3 Website Interface	6-54
6.3.1 Geographic Areas by State (or Island Area):	6-58
6.3.2 Features by State:	6-58
6.3.3 National Files:.....	6-58
6.3.4 National Features:.....	6-58
6.3.5 Core Based Statistical Areas (CBSA)	6-59
6.3.6 School Districts	6-60
6.3.7 State Legislative District.....	6-60
6.3.8 Features: Landmarks.....	6-61
6.3.9 Features: Roads	6-61
6.3.10 Features: Water.....	6-62
6.3.11 Relationship files	6-63
6.4 Web Interface, Archive FTP.....	6-64
6.5 Direct from FTP Site.....	6-70
6.6 Connect via FTP Client	6-70
6.7 Data.gov.....	6-76
7. Useful Links.....	7-81
7.1 User Notes.....	7-81
7.2 Help Documents	7-81
7.3 Additional TIGER Products for use in a GIS.....	7-82
7.3.1 TIGER Geodatabases	7-82
7.3.2 TIGER/Line Shapefiles and Geodatabases with Demographic Data.....	7-82
7.3.3 Cartographic Boundary Files	7-82
Appendix A. Pseudo-School Districts	83
Appendix B. Feature Name Directions.....	86
Appendix C. Feature Name Qualifiers	87
Appendix D. Feature Name Types.....	88
Appendix E. 2020 MAF/TIGER Feature Class Code (MTFCC) Definitions.....	102
Appendix F. Record Layouts: American Indian, Alaska Native, Native Hawaiian	121
Appendix F-1. Record Layout: ANRC Shapefile	121
Appendix F-2. Record Layout: AIANNH Shapefile.....	122
Appendix F-3. Record Layout: AITS Shapefile	123
Appendix F-4. Record Layout: Tribal Census Tract Shapefile	124
Appendix F-5. Record Layout: Tribal Block Group Shapefile.....	124
Appendix G. Record Layouts: Block and Census Tract.....	125

Appendix G-1. Record Layout: Block State-based Shapefile.....	125
Appendix G-2. Record Layout: Block Group State-based Shapefile	126
Appendix G-3. Record Layout: Census Tract State-based Shapefile.....	127
Appendix H. Record Layouts: Congressional District Shapefile	128
Appendix H-1. Record Layout: 116 th Congressional District Shapefile	128
Appendix H-2. Record Layout: State Legislative District Lower Chambers (SLDL).....	128
Appendix H-3. Record Layout: State Legislative District Upper Chambers (SLDU) Shapefile	129
Appendix I. Record Layouts: Places and County Subdivisions	130
Appendix I-1. Record Layout: Consolidated City Shapefile.....	130
Appendix I-2. Record Layout: County and Equivalent Entity Shapefile	131
Appendix I-3. Record Layout: County Subdivision State-based Shapefile.....	132
Appendix I-4. Record Layout: Estate Shapefile (U.S. Virgin Islands Only).....	133
Appendix I-5. Record Layout: Place State-based Shapefile	134
Appendix I-6. Record Layout: Subbarrio Shapefile.....	135
Appendix J. Record Layouts: Hydrography (Area and Line).....	136
Appendix J-1. Record Layout: Area Hydrography Shapefile.....	136
Appendix J-2. Record Layout: Linear Hydrography Shapefile	136
Appendix K. Record Layout: Landmarks (Area and Point)	137
Appendix K-1. Record Layout: Area Landmark Shapefile	137
Appendix K-2. Record Layout: Point Landmark Shapefile.....	138
Appendix L. Record Layout: Linear Features Shapefile	138
Appendix L-1. Record Layout: All Lines County-based Shapefile	138
Appendix L-2. Record Layout: Coastlines Shapefile	140
Appendix L-3. Record Layouts: Roads Shapefile.....	140
Appendix L-3.1 Record Layout: Roads, Primary, National Shapefile	140
Appendix L-3.2 Record Layout: Roads, Primary and Secondary State Shapefile	141
Appendix L-3.3 Record Layout: All Roads, County Shapefile.....	141
Appendix L-4. Record Layout: Address Ranges Feature County Shapefile	142
Appendix L-5. Record Layouts: Railroads National Shapefile	143
Appendix M. Record Layouts: Metropolitan and Micropolitan Shapefiles.....	144
Appendix M-1. Record Layout: CNECTA National Shapefile.....	144
Appendix M-2. Record Layout: CSA National Shapefile	144
Appendix M-3. Record Layout: Metropolitan Division National Shapefile.....	145
Appendix M-4. Record Layout: CBSA National Shapefile	146
Appendix M-5. Record Layout: New England City and Town Area (NECTA) Shapefile	147
Appendix M-6. Record Layout: NECTA Division National Shapefile.....	147
Appendix N. Record Layout: Military Installation National Shapefile	148
Appendix O. Record Layouts: PUMA's, Urban Areas, ZCTA Shapefiles	149

Appendix O-1. Record Layout: Public Use Microdata Area State-based Shapefile	149
Appendix O-2. Record Layout: Urban Areas National Shapefile.....	150
Appendix O-3. Record Layout: 5 Digit ZIP Code Tabulation (ZCTA5) National Shapefile	150
Appendix P. Record Layouts: School Districts Shapefiles	151
Appendix P-1. Record Layout: Elementary School District State Shapefile	151
Appendix P-2. Record Layout: Secondary School District State Shapefile.....	152
Appendix P-3. Record Layout: Unified School District State Shapefile	153
Appendix P-4. Record Layout: State and Equivalent Entity National Shapefile.....	154
Appendix Q. Record Layout: Topological Faces County Shapefile	154
Appendix R. Record Layouts: Relationship Files Shapefile.....	157
Appendix R-1. Record Layout: Address Range County-based Relationship File.....	157
Appendix R-2. Record Layout: Address Range Feature Name County Relationship File.....	157
Appendix R-3. Record Layout: Feature Names County based Relationship File.....	158
Appendix R-4. Record Layouts: Topological Faces Relationship Files	159
Appendix R-4.1 Record Layout: Topological Faces Area Landmark County Relationship File ...	159
Appendix R-4.2 Record Layout: Topological Faces Area Hydrography County Relationship	159
Appendix R-4.3 Record Layout: Topological Faces Area Military Installation National Relationship	159
Appendix S. Shapefile and Relationship File Names.....	160
Appendix T. Glossary	162

Table of Figures

Figure 1: 2020 Shapefile availability	3-7
Figure 2: 2020 Relationship file availability.....	3-7
Figure 3: Shapefiles File Types	3-9
Figure 4: Relationship File Types	3-9
Figure 5: File Naming Conventions.....	3-10
Figure 6: Datum Field definition list.....	3-10
Figure 7: Census Codes for each AIANNH area	4-16
Figure 8: AIANNHR Recognition Flag.....	4-16
Figure 9: Functional Status for G2170 joint use areas	4-16
Figure 10: FIPS Class Codes for Federal AIRS or ORTLs.....	4-16
Figure 11: Component types for AIANNH areas.....	4-17
Figure 12: Census Block	4-20
Figure 13: Geographic Relationships: County Subdivision Place Block.....	4-21

Figure 14: Congressional Districts: FIPS Codes.....	4-24
Figure 15: County Equivalents.....	4-25
Figure 16: MCD areas.....	4-26
Figure 17: MCD States.....	4-27
Figure 18: Census County Divisions.....	4-27
Figure 19: Unorganized Territories	4-28
Figure 20: Undefined County Subdivisions.....	4-28
Figure 21: Feature Types.....	4-31
Figure 22: Metropolitan and Micropolitan Statistical Areas.....	4-33
Figure 23: CBSA codes.....	4-35
Figure 24: Geographic Corridors – Overview	4-38
Figure 25: Geographic Corridors Address Ranges.....	4-39
Figure 26: School Districts: Pseudo-secondary	4-41
Figure 27: State Legislative Districts.....	4-43
Figure 28: TIGER/Line Shapefiles Address Range Basics.....	5-47
Figure 29: Address Range Product Comparison	5-48
Figure 30: TIGER/Line Shapefile Address Range Imputes - Before Split	5-50
Figure 31: TIGER/Line Shapefile Address Range Imputes - After Split	5-51
Figure 32: TIGER/Line Shapefiles base screen	6-55
Figure 33: TIGER/Line Shapefiles: Pick Year Version	6-55
Figure 34: TIGER/Line Shapefiles Selecting Web Interface.....	6-56
Figure 35: TIGER/Line Shapefiles year and website interface base screen	6-56
Figure 36: TIGER/Lines Shapefiles menu after submit pressed.....	6-57
Figure 37: TIGER/LINE Shapefiles selecting American Indian/Alaska Native/Native Hawaiian Area.....	6-57
Figure 38: TIGER/Line Shapefiles open, save, cancel options	6-58
Figure 39: TIGER/Line Shapefiles Core Based Statistical Areas menu	6-59
Figure 40: TIGER/Line Shapefiles School Districts Menu	6-60
Figure 41: TIGER/Line Shapefiles: State Legislative Districts Menu.....	6-60
Figure 42: TIGER/Line Shapefiles: Landmarks Menu	6-61
Figure 43: TIGER/Line Shapefiles: Roads Menu.....	6-61
Figure 44: TIGER/Line Shapefiles: Water Menu.....	6-62
Figure 45: TIGER/Line Shapefiles: Relationship Files Menu.....	6-63
Figure 46: TIGER/Line Shapefiles, FTP site for download	6-64
Figure 47: TIGER/Line Shapefiles start menu	6-64
Figure 48: TIGER/Line Shapefiles, FTP Archive	6-65
Figure 49: FTP Archive, Part 1	6-65
Figure 50: FTP Archive, Part 2	6-66

Figure 51: FTP Archive, Part 3	6-67
Figure 52: TRACT Selection	6-67
Figure 53: TRACT individual files, Part 1	6-68
Figure 54: TRACT individual files, Part 2	6-69
Figure 55: TRACT individual files, Part 3	6-70
Figure 56: FTP Root, Part 1	6-71
Figure 57: FTP Root, Part 2	6-72
Figure 58: FTP Root, Part 3	6-73
Figure 59: FTP Client, Select GEO	6-73
Figure 60: FTP Client, Select Tiger	6-73
Figure 61: FTP Client, Directory results for geo/tiger	6-74
Figure 62: Directory of Geo/tiger/TIGER2019, Part 1	6-75
Figure 63: Directory of Geo/tiger/TIGER2019, Part 2	6-76
Figure 64: Directory of Geo/tiger/TIGER2019/COUNTY	6-76
Figure 65: Data.gov	6-77
Figure 66: Data.gov Data tab selection	6-77
Figure 67: Data.gov Data tab results	6-78
Figure 68: Data.gov Organization selection	6-78
Figure 69: Data.gov Organization menu	6-79
Figure 70: Data.gov Census Bureau menu	6-80
Figure 71: Appendix A: Unified School Districts	83
Figure 72: Appendix A: Elementary School Districts	83
Figure 73: Appendix A: Secondary School Districts	85
Figure 74: Appendix B: Feature Name Directions	86
Figure 75: Appendix C: Feature Name Qualifiers	87
Figure 76: Appendix D: Feature Name Types	101
Figure 77: Appendix E: MTFCC Definitions	120
Figure 78: Appendix F-1: ANRC Shapefile Record Layout	121
Figure 79: Appendix F-2: AIANNH Shapefile Record Layout	122
Figure 80: Appendix F-3: AITS Shapefile Record Layout	123
Figure 81: Appendix F-4: Tribal Census Tract Shapefile Record Layout	124
Figure 82: Appendix F-5: Tribal Block Group Shapefile Record Layout	125
Figure 83: Appendix G-1: Block State-based Shapefile Record Layout	126
Figure 84: Appendix G-2: Block Group State-based Shapefile Record Layout	127
Figure 85: Appendix G-3: Census Tract State-based Shapefile Record Layout	127
Figure 86: Appendix H-1: 116th Congressional District National Shapefile Record Layout	128
Figure 87: Appendix H-2: SLDL State-based Shapefile Record Layout	129

Figure 88: Appendix H-3: SLDU State-based Shapefile Record Layout	130
Figure 89: Appendix I-1: Consolidated City Shapefile Record Layout.....	131
Figure 90: Appendix I-2: County and Equivalent Entity National Shapefile Record Layout	132
Figure 91: Appendix I-3: County Subdivision State-based Shapefile Record Layout	133
Figure 92: Appendix I-4: Estate Shapefile (U.S. Virgin Islands Only) Record Layout	133
Figure 93: Appendix I-5: Place State-based Shapefile Record Layout	134
Figure 94: Appendix I-6: Subbarrio State-based Shapefile Record Layout.....	135
Figure 95: Appendix J-1: Area Hydrography County-based Shapefile Record Layout	136
Figure 96: Appendix J-2: Linear Hydrography County-based Shapefile Record Layout.....	137
Figure 97: Appendix K-1: Area Landmark State-based Shapefile Record Layout	137
Figure 98: Appendix K-2: Point Landmark State-based Shapefile Record Layout.....	138
Figure 99: Appendix L-1: All Lines County-based Shapefile Record Layout.....	140
Figure 100: Appendix L-2: Coastline National Shapefile Record Layout.....	140
Figure 101: Appendix L-3.1: Primary Roads National Shapefile Record Layout.....	140
Figure 102: Appendix L-3.2: Primary and Secondary Roads State-based Shapefile Record Layout	141
Figure 103: Appendix L-3.3: All Roads County-based Shapefile Record Layout.....	141
Figure 104: Appendix L-4: Address Range Feature County-based Shapefile Record Layout.....	143
Figure 105: Appendix L-5: Railroads National Shapefile Record Layout	143
Figure 106: Appendix M-1: CNECTA National Shapefile Record Layout.....	144
Figure 107: Appendix M-2: CSA National Shapefile Record Layout	145
Figure 108: Appendix M-3: Metropolitan Division National Shapefile Record Layout	146
Figure 109: Appendix M-4: CBSA National Shapefile Record Layout.....	146
Figure 110: Appendix M-5: NECTA National Shapefile Record Layout	147
Figure 111: Appendix M-6: NECTA Division National Shapefile Record Layout.....	148
Figure 112: Appendix N: Military Installation National Shapefile Record Layout.....	149
Figure 113: Appendix O-1: Public Use Microdata Area (PUMA) State-based Shapefile Record Layout	149
Figure 114: Appendix O-2: Urban Area (UA) National Shapefile Record Layout.....	150
Figure 115: Appendix O-3: ZCTA5 National Shapefile Record Layout	151
Figure 116: Appendix P-1: Elementary School District State-based Shapefile Record Layout.....	152
Figure 117: Appendix P-2: Secondary School District State-based Shapefile Record Layout.....	152
Figure 118: Appendix P-3: Unified School District State-based Shapefile Record Layout.....	153
Figure 119: Appendix P-4: State and Equivalent Entity National Shapefile Record Layout.....	154
Figure 120: Appendix Q: Topological Faces - Polygons All Geocodes County-based Shapefile Record Layout	156
Figure 121: Address Ranges County-based Relationship File Record Layout	157
Figure 122: Appendix R-2: Address Range-Feature Name County-based Relationship File Record Layout	157

Figure 123: Appendix R-3: Feature Names County-based Relationship File Record Layout	159
Figure 124: Appendix R-4.1: Topological Faces-Area Landmark County-based Relationship File Record Layout	159
Figure 125: Appendix R-4.2: Topological Faces-Area Hydrography County-based Relationship File Record Layout.....	159
Figure 126: Appendix R-4.3: Topological Faces-Military Installation National Relationship File Record Layout	159
Figure 127: Appendix S: Shapefile and Relationship File Names	160
Figure 128: Geographic Area values	161
Figure 129: Appendix T: Glossary	164

1. Legal Disclaimer, Citation Information and Contact

1.1 TIGER/Line Shapefile Legal Disclaimers

No warranty, expressed or implied, is made with regard to the accuracy of the data in the TIGER/Line Shapefiles, and no liability is assumed by the United States Government in general, or the Census Bureau specifically, as to the positional or attribute accuracy of the data. The boundary information in the TIGER/Line Shapefiles is for statistical data collection and tabulation purposes only. Their depiction and designation for statistical purposes does not constitute a determination of jurisdictional authority or rights of ownership or entitlement and are not legal land descriptions.

TIGER/Line® is a registered trademark of the Census Bureau. TIGER/Line cannot be used as or within the proprietary product names of any commercial product including or otherwise relevant to Census Bureau data and may only be used to refer to the nature of such a product. The Census Bureau requests that any repackaging of the TIGER/Line Shapefile data, documentation, and other files accompanying it for distribution include a conspicuously placed statement to this effect on the product's cover, the first page of the website, or elsewhere of comparable visibility. Further, Census Bureau trademarks, when used in reference to the nature of the product, should be accompanied by the ® (registered) symbol or ™ symbol, where convenient.

1.2 Citation Information

Copyright protection is not available for any work of the United States Government (Title 17 U.S.C., Section 105). Thus, you are free to reproduce census materials as you see fit. We would ask, however, that you [cite](#) the Census Bureau as the source.

1.3 Contact Information

Members of the public can obtain the TIGER/Line Shapefiles free of charge through the Census Bureau's website and should direct questions about these files to the Spatial Data Collection and Products Branch, Geography Division, U.S. Census Bureau. If you obtain the TIGER/Line Shapefiles from a third party, we recommend you contact that vendor for assistance.

Spatial Data Collection and Products Branch
Geography Division,
U.S. Census Bureau
4600 Silver Hill Road
Washington, DC 20233-7400
Office: (301) 763-1128
E-mail: geo.geography@census.gov

2. Introduction

2.1 What is a Shapefile?

Shapefiles are digital representations of geographic features (e.g., lakes, landmarks, roads, and boundaries) used to create maps. A shapefile stores non-topological geometry and attribute information for the spatial features in a data set. The Census Bureau provides shapefile layers in Environmental Systems Research Institute* (Esri) shapefile format.

* The use of brand names does not represent an endorsement of a company or its products by the U.S. government. Due to the wide use of Esri products by our partners in the Geographic Information System (GIS) community, and ubiquitous use of the shapefile format as a medium for GIS data exchange, the Census Bureau provides data in shapefile format.

2.2 What are TIGER/Line Shapefiles?

The TIGER/Line Shapefiles are extracts of selected geographic and cartographic information from the Census Bureau's Master Address File (MAF)/Topologically Integrated Geographic Encoding and Referencing (TIGER) Database (MTDB). The shapefiles include information for the fifty states, the District of Columbia, Puerto Rico, and the Island areas (American Samoa, the Commonwealth of the Northern Mariana Islands, Guam, and the United States Virgin Islands). The shapefiles include polygon boundaries of geographic areas and features, linear features including roads and hydrography, and point features. These shapefiles do not contain any sensitive data or confidential data protected by [Title 13](#) of the U.S.C.

2.3 Relationship of the TIGER/Line Shapefiles to Census Statistical Data

The TIGER/Line Shapefiles contain a standard geographic identifier (GEOID) for each entity that links to the GEOID in the data from censuses and surveys. The TIGER/Line Shapefiles do not include demographic data from surveys and censuses (e.g., Decennial Census, Economic Census, American Community Survey, and the Population Estimates Program). Other, non-census, data often have this standard geographic identifier as well. Data from many of the Census Bureau's surveys and censuses, including the geographic codes needed to join to the TIGER/Line Shapefiles, are available at the Census Bureau's public data dissemination website (<https://data.census.gov/>). For more information regarding the geographic entity codes, please refer to [Section 3.2.7 Codes for Geographic Entities](#).

In addition to the TIGER/Line Shapefiles, the Census Bureau creates additional shapefiles and geodatabases that include demographic data. These are as-is products and are created by Census Bureau staff as time permits. All shapefiles and geodatabases with demographic data are available at

[<https://www.census.gov/geographies/mapping-files/time-series/geo/tiger-data.html>](https://www.census.gov/geographies/mapping-files/time-series/geo/tiger-data.html)

2.4 History and Sources of TIGER/Line Files and Shapefiles

The first release of the TIGER/Line Files was in 1989. These files provided the first nationwide street centerline coverage of the United States, Puerto Rico, and the Island Areas in a series of American Standard Code for Information Interchange (ASCII) format fixed tables or record types. Initially, the Census Bureau used the U.S. Geological Survey (USGS) 1:100,000-scale Digital Line Graph (DLG), USGS 1:24,000-scale quadrangles, the Census Bureau's 1980 geographic base files (GBF/DIME Files), and a variety of miscellaneous maps for selected areas outside the contiguous 48 states to create the TIGER Database (predecessor to the current MTDB). The Census Bureau released versions of the TIGER/Line Files periodically throughout the 1990s and 2000s in ASCII format. Beginning with the 2007 version, the format of the TIGER/Line files changed from the ASCII file format to shapefile.

The Census Bureau continually makes additions and corrections to the MTDB, mainly through partner-supplied data, the use of aerial imagery, and fieldwork. The Census Bureau has numerous partner programs where federal, state, and local government partners supply updates to boundaries, features, and addresses. In the 2000s, the Census Bureau underwent a major realignment of the MTDB to improve the spatial accuracy of the road network. Since this realignment, the Census Bureau has added quality standards for data sources used to update the MTDB.

3. About the 2020 TIGER/Line Shapefiles

3.1 What is in the 2020 TIGER/Line Shapefiles

The 2020 TIGER/Line Shapefiles contain current geographic extent and boundaries of both legal and statistical entities (which have no governmental standing) for the United States, the District of Columbia, Puerto Rico, and the Island areas. This vintage includes boundaries of governmental units that match the data from the surveys that use 2020 geography (e.g., 2020 Population Estimates and the 2020 American Community Survey).

In addition to geographic boundaries, the 2020 TIGER/Line Shapefiles also include geographic feature shapefiles and relationship files. Feature shapefiles represent the point, line and polygon features in the MTDB (e.g., roads and rivers). Relationship files contain additional attribute information users can join to the shapefiles. Both the feature shapefiles and relationship files reflect updates made in the database through September 2020.

To see how the geographic entities, relate to one another, please see our geographic hierarchy diagrams here:

<https://www.census.gov/programs-surveys/geography/guidance/hierarchy.html>

The legal entities included in these shapefiles are:

- American Indian Off-Reservation Trust Lands.
- American Indian Reservations – Federal.
- American Indian Reservations – State.
- American Indian Tribal Subdivisions (within legal American Indian areas).
- Alaska Native Regional Corporations.
- Congressional Districts – 116th Congress.
- Consolidated Cities.
- Counties and Equivalent Entities (except census areas in Alaska).
- Estates (U.S. Virgin Islands only).
- Hawaiian Home Lands.
- Incorporated Places.
- Minor Civil Divisions.
- School Districts – Elementary.
- School Districts – Secondary.
- School Districts – Unified.
- States and Equivalent Entities.
- State Legislative Districts – Upper.
- State Legislative Districts – Lower.
- Subminor Civil Divisions (Subbarrios in Puerto Rico).

The statistical entities included in these shapefiles are:

- Alaska Native Village Statistical Areas.
- American Indian/Alaska Native Statistical Areas.
- American Indian Tribal Subdivisions (within Oklahoma Tribal Statistical Areas).
- Block Groups.

- Census Areas.
- Census Blocks.
- Census County Divisions (Census Subareas in Alaska).
- Unorganized Territories (statistical county subdivisions).
- Census Designated Places (CDPs).
- Census Tracts.
- Combined New England City and Town Areas.
- Combined Statistical Areas.
- Metropolitan and Micropolitan Statistical Areas and related statistical areas.
- Metropolitan Divisions.
- New England City and Town Areas.
- New England City and Town Area Divisions.
- Oklahoma Tribal Statistical Areas.
- Public Use Microdata Areas (PUMAs).
- State Designated Tribal Statistical Areas.
- Tribal Designated Statistical Areas.
- Urban Areas.
- ZIP Code Tabulation Areas (ZCTAs).

Shapefiles - Features

- Address Range-Feature.
- All Lines (called Edges).
- All Roads.
- Area Hydrography.
- Area Landmark.
- Coastline.
- Linear Hydrography.
- Military Installation.
- Point Landmark.
- Primary Roads.
- Primary and Secondary Roads.
- Topological Faces (polygons with all geocodes)

Relationship Files

- Address Range-Feature Name.
- Address Ranges.
- Feature Names.
- Topological Faces – Area Landmark.
- Topological Faces – Area Hydrography.
- Topological Faces – Military Installations

Figure 1 shows the geographic entities and features available in nation, state, or county-based files for the 2020 TIGER/Line Shapefiles.

Layer	Nation-Based File	State-Based File	County-Based File
Address Range-Feature			X
Alaska Native Regional Corporation		X	
All Lines (Edges)			X
All Roads			X
American Indian Tribal Subdivision	X		
American Indian/Alaska Native/Native Hawaiian Areas	X		
Area Hydrography			X
Area Landmark		X	
Block		X	
Block Group		X	
Census Tract		X	
Coastline	X		
Combined New England City and Town Area	X		
Combined Statistical Area	X		
Congressional District – 116th Congress	X		
Consolidated City		X	
Core Based Statistical Areas	X		
County and Equivalent	X		
County Subdivision		X	
Elementary School District		X	
Estates		X	
Linear Hydrography			X
Metropolitan Divisions	X		
Military Installation	X		
New England City and Town Area	X		
New England City and Town Division	X		
Place		X	
Point Landmark		X	
Primary and Secondary Roads		X	
Primary Roads	X		

Layer	Nation-Based File	State-Based File	County-Based File
Public Use Microdata Area		X	
Rails	X		
Secondary School District		X	
State and Equivalent	X		
State Legislative District – Lower Chamber		X	
State Legislative District – Upper Chamber		X	
Subbarrio		X	
Topological Faces (Polygons with All Geocodes)			X
Tribal Block Group	X		
Tribal Census Tract	X		
Unified School District		X	
Urban Areas	X		
ZIP Code Tabulation Area	X		

Figure 1: 2020 Shapefile availability

Figure 2 shows the relationship files available in nation, state, or county-based levels for the 2020 TIGER/Line Shapefiles.

Layer	Nation-Based File	State-Based File	County-Based File
Address Range-Feature Name			X
Address Ranges			X
Feature Names			X
Topological Faces – Area Landmark		X	
Topological Faces – Area Hydrography			X
Topological Faces – Military Installations	X		

Figure 2: 2020 Relationship file availability

3.2 File Changes and Updates for the 2020 TIGER/Line Shapefiles

3.2.1 List of files

The 2020 TIGER/Line Shapefiles include the following updates:

- No changes for 2020.
- The following shapefiles may have boundary updates:
 - County and equivalents
 - County Subdivisions
 - Places
 - School Districts
 - State Legislative Districts
 - Census Designated Places
 - Census Tracts
 - Census Block Groups

3.2.2 Boundary Changes

Most of the boundaries of federally recognized American Indian Reservations (AIRs) and Off-Reservation Trust Lands (ORTLs), tribal subdivisions, states and equivalent entities, counties and equivalent entities, Minor Civil Divisions (MCDs), consolidated cities, and incorporated places generally are those that were legally in effect as of January 1, 2020. The Boundary and Annexation Survey (BAS) collects boundaries of legal areas.

For more information about the BAS, please visit:

<<https://www.census.gov/programs-surveys/bas.html>>

For more information about specific boundary changes, please visit:

<<https://www.census.gov/geographies/reference-files/time-series/geo/bas/annex.html>>

For nearly all statistical areas, the boundaries shown have been updated as a part of the Participant Statistical Areas Program (PSAP). Current geography may differ from 2010 Census geography due to changes from several sources: in the case of census tracts and block groups, the most common changes are splitting or merging 2010 entities to accommodate population changes in the past decade. Small boundary changes to statistical entities may also follow feature update or align disparate geographic entities for database hygiene. For example, if a street feature that acts as a census tract boundary moves, then the census tract boundary will move as well. In addition, census tract boundaries may change to maintain comparability with related geographies (e.g., incorporated places). Census designated places (CDPs) may also change throughout the decade, and as time permits, the Census Bureau adds new CDPs to the database. Unorganized territories and CDPs occupy the same level of geography as legal MCD and incorporated places, updates to the legal boundaries may affect the current boundaries for some of these entities, including the elimination of some of the statistical entities. Census county divisions (CCDs) are employed by the Census Bureau to organize sub-county geography in states that do not have legal MCDs, and changes to these entities will reflect similar small boundary adjustments describe above as well as efforts to maintain nesting relationships with census tracts, where the latter have received substantial updates. Changes to census tract, block group, and CDP entities have come from both internal and partner proposals for the 2020 Census. Statistical areas which are not based on

2020 data in this product include Public Use Microdata Areas (PUMAs) and ZIP Code Tabulation Areas (ZCTAs), as these entities are delineated post-decennial publication.

3.3 Structure and Format

3.3.1 Structure

The Census Bureau provides 2020 TIGER/Line Shapefiles and associated relationship on the Census Bureau website in a compressed format. One zipped file is available for each layer, with a file extension of .zip. Each zipped shapefile consists of the following seven files:

File Type	Description
.cpg	Identify character encoding
.dbf	Tabular attribute information (database)
.prj	Coordinate System Information
.shp	Feature Geometry
.shx	Index of the Feature Geometry
.shp.iso.xml	International Organization for Standardization (ISO 191) metadata in Extensible Markup Language (XML) format.
.shp.ea.iso.xml	Entity and Attribute of ISO 191 metadata in XML format.

Figure 3: Shapefiles File Types

Each zipped relationship file consists of the following four files:

File Type	Description
.cpg	Identify character encoding
.dbf	Tabular attribute information (database)
.dbf.iso.xml	International Organization for Standardization (ISO 191) metadata in Extensible Markup Language (XML) format.
.dbf.ea.iso.xml	Entity and Attribute of ISO 191 metadata in XML format.

Figure 4: Relationship File Types

3.3.2 File Naming Conventions

The name of each file is:

tl_YYYY_<extent>_<layer>.<ext>

Where:

Name	Description
tl	TIGER/Line
YYYY	Year version of the files
<extent>	Parent geography entity ID code (variable length of two to five characters). The entity ID identifies the geographic extent by specific entity for which the file contains data (variable length depending on the type of file).
Nation-based	2 character abbreviation US
State-based	2 character state FIPS code
County-based	5 character state and county FIPS code

<layer>	Layer tag (variable length). The layer tag specifies the type of geography or feature the file contains.
<ext>	File extension

Figure 5: File Naming Conventions

Examples:

Nation-based shapefile: County and Equivalent shapefile

File Name: tl_YYYY_us_county.shp

State-based shapefile: State and Equivalent shapefile for Maryland

File Name: tl_YYYY_24_state.shp

County-based shapefile: All Lines shapefile for Montgomery County, Maryland

File Name: tl_YYYY_24031_edges.shp

3.3.3 Datum (GCS NAD 83)

Each shapefile contains a project (.prj) file that contains the GIS industry standard well-known text (WKT) format to describe the coordinate system, projection, datum information for each shapefile. All Census Bureau generated shapefiles are in Global Coordinate System North American Datum of 1983 (GCS NAD83). Each .prj file contains the following:

```
GEOGCS["GCS_North_American_1983",DATUM["D_North_American_1983",SPHEROID["GRS_1980",6378137,298.257222101]],PRIMEM["Greenwich",0],UNIT["Degree",0.017453292519943295]]
```

Field	Description
GEOGCS	A coordinate system based on based on latitude and longitude.
DATUM	The horizontal datum, which corresponds to the procedure used to measure positions on the surface of the Earth.
SPHEROID	An approximation of the Earth's surface as a squashed sphere.
PRIMEM	The prime meridian used to take longitude measurements (from). The longitude units will match those of the geographic coordinate system.
UNIT	This describes units used for values elsewhere within the parent WKT clause. The physical dimension (i.e. type) of the units determined by context. For example, the type of the units is angular.

Figure 6: Datum Field definition list

3.3.4 Metadata

Metadata describes the quality, purpose, spatial extent, and history of a dataset. The metadata files are compatible with a text editor, web browser, or Esri's ArcCatalog. The TIGER/Line Shapefiles metadata provide a detailed description of the TIGER/Line Shapefiles and relationship files. The metadata includes publication date, contact information, and all the valid attribute values and descriptions. Users should refer to the metadata files for extensive documentation about the contents of the shapefiles and relationship files. The all lines metadata also contains a Spatial Metadata Identifier (SMID), which identifies the source of the coordinates for each edge and the horizontal spatial accuracy information for a line. Please note that the horizontal spatial accuracy refers only to those edges identified as matched to the source with that accuracy and is not the spatial accuracy of the all lines shapefile as a whole. For more information regarding the all lines Shapefile, please refer to [Section 4.12, Linear Features](#).

Note: 2020 TIGER/Line files are in ISO 19115-3 stylesheet, as required by data.gov. However, Esri's ArcCatalog needs to be in the ISO 19139 stylesheet (entire metadata element values).

<<https://community.esri.com/thread/228884-problem-with-tigerline-2018-metadata>>

3.3.5 Spatial Accuracy of Linear Features

In order to maintain a current geographic database from which to extract the TIGER/Line Shapefiles, the Census Bureau uses various internal and external processes to update the MTDB. While it has made a reasonable and systematic attempt to gather the most recent information available about the features each file portrays, the Census Bureau cautions users that the files are no more complete than the source documents used in their compilation, the vintage of those source documents, and the translation of the information on those source documents.

3.3.6 Coordinates

Coordinates in the TIGER/Line Shapefiles have six decimal places, but the positional accuracy of these coordinates may not be as great as the six decimal places suggest. The spatial accuracy varies with the source materials used. The Census Bureau cannot specify the spatial accuracy of features changed or added by field staff or through local updates, features derived from the GBF/DIME Files (TIGER's predecessor in 1970 and 1980), or other map or digital sources.

3.3.7 Codes for Geographic Entities

The 2020 TIGER/Line Shapefiles includes the American National Standards Institute (ANSI) codes to identify both legal and statistical entities.

The ANSI publications include both the Federal Information Processing Series (FIPS) codes and the U.S. Geological Survey's Geographic Names Information System (GNIS) codes. The FIPS codes appear in the 2020 TIGER/Line Shapefiles in fields (e.g., "STATEFP", where "FP" indicates that the field contains a FIPS code). The GNIS codes are a permanent numeric identifier of up to eight digits. The GNIS codes appear in fields (e.g., "STATENS", where "NS" [National Standard] indicates that the field contains a GNIS code). The Census Bureau stores the GNIS code as a fixed-width string; the official code is a numeric value without leading zeroes. The GNIS code is available beginning in the 2010 TIGER/Line Shapefiles. For geographic entities not covered by ANSI, the Census Bureau assigns a code, and these appear in fields (e.g., "TRACTCE", where "CE" stands for Census). Finally, state-submitted codes end in "ST", (e.g., "SLDLST"), and local education agency codes end in "LEA", as in "ELSDLEA".

For more information about ANSI codes, please visit:

<<https://www.census.gov/library/reference/code-lists/ansi.html>>

4. Geographic Shapefile Concepts Overview

The following sections describe the geographic entity type displayed in each shapefile, as well as the record layout for each file, in alphabetical order. A listing of all available shapefiles, including vintage and geographic level (state, county and national), precedes the description of the entity type. Shapefiles do not exist for geographic layers where there is no data in the MTDB (e.g., states that have no American Indian/Alaska Native/Native Hawaiian Areas will not have an AIANNH shapefile).

4.1 American Indian / Alaska Native / Native Hawaiian (AIANNH) Areas

4.1.1 Alaska Native Regional Corporations (ANRCs)

Alaska Native Regional Corporations geography and attributes are available in the following shapefile:

Alaska Native Regional Corporation (ANRC) State Shapefile (Current)

ANRCs are corporations created according to the Alaska Native Claims Settlement Act (Pub. L. 92–203, 85 Stat. 688 (1971); 43 U.S.C. 1602 et seq. (2000)). The laws of Alaska organize Regional Corporations to conduct both the for-profit and non-profit affairs of Alaska Natives within defined regions of the state. The Census Bureau treats ANRCs as legal geographic entities. Twelve ANRCs cover Alaska except for the area within the Annette Island Reserve (an AIR under the governmental authority of the Metlakatla Indian Community). The Census Bureau offers representatives of the twelve ANRCs the opportunity to review and update the ANRC boundaries.

TIGER/Line Shapefiles represent ANRCs with a 5-character FIPS code unique within Alaska and a nationally unique 8-character ANSI code.

See [Appendix F-1 for ANRC record layout](#).

4.1.2 American Indian/Alaska Native/Native Hawaiian (AIANNH) Areas

American Indian, Alaska Native and Native Hawaiian area geography and attributes are available in the following shapefile:

American Indian/Alaska Native/Native Hawaiian (AIANNH) Area National Shapefile (Current)

This shapefile contains both legal and statistical AIANNH entities for which the Census Bureau publishes data. The legal entities consist of federally recognized AIR and ORTL areas, state-recognized AIRs and Hawaiian Home Lands (HHLs). American Indian Tribal Subdivisions (AITS) and Alaska Native Regional Corporations (ANRCs) are additional types of legal entities, displayed in separate shapefiles discussed in this chapter. The statistical entities displayed in these shapefiles are Alaska Native Village Statistical Areas (ANVSAs), Oklahoma Tribal Statistical Areas (OTSAs), Tribal Designated Statistical Areas (TDSAs), and State Designated Tribal Statistical Areas (SDTSAs).

The AIANNH shapefiles contain a unique polygon record for each AIR or ORTL, HHL, ANVSA, and American Indian statistical geographic entity.

For example, the Fort Peck Indian Reservation will have two records: one for the reservation portion and another for the Off-Reservation Trust Land portion.

Entities with only a single component (e.g., HHL, ANVSA, American Indian statistical geographic entity, reservation without any associated ORTL, or an entity that is only ORTL), will contain a single record.

AIANNH areas cannot overlap another tribal entity. Tribal subdivisions are the exception, which subdivide some American Indian entities and ANVSAs that exist within ANRCs. In cases where more than one tribe claims jurisdiction over an area, the Census Bureau creates a joint-use area as a separate entity to define this area of dual claims.

See [Appendix F-2 for AIANNH record layout](#).

4.1.2.1 Legal Entity Definitions

American Indian Reservations—Federal (federal AIRs)

Federal AIRs are areas set aside by the United States for the use of federally recognized tribes. The exterior boundaries of federal AIRs are in tribal treaties, agreements, executive orders, federal statutes, secretarial orders and/or judicial determinations. The Census Bureau recognizes federal reservations as territory over which American Indian tribes have governmental authority (e.g., colonies, communities, Indian colonies, Indian communities, Indian Rancherias, Indian Reservations, Indian villages, pueblos, rancherias, ranches, reservations, reserves, settlements, villages, or other descriptions). The Bureau of Indian Affairs (BIA) within the U.S. Department of Interior regularly publishes a list of federally recognized tribal governments in the Federal Register. The Census Bureau contacts representatives of these federally recognized American Indian tribal governments to identify the boundaries for federal reservations. Federal reservations may cross state, county, county subdivision, and/or place boundaries.

Contact information for federally recognized tribes; please visit the Bureau of Indian Affairs website at <https://www.bia.gov/>

< <https://www.usa.gov/tribes> >

Census Bureau assigns each federal AIR and reservation equivalent joint-use area with a nationally unique 4-character census code (0001 to 4999). These census codes are in alphabetical order of AIR names nationwide, except that joint-use areas appear at the end of the code range (4900 to 4999). Federal AIRs and reservation equivalent joint-use areas also have a nationally unique 8-character GNIS code.

American Indian Reservations—State (state AIRs)

Some state governments establish state AIRs for tribes recognized by the state. A governor-appointed state liaison provides the names and boundaries for state-recognized AIRs to the Census Bureau. State reservations may cross county, county subdivision and/or place boundaries.

Census Bureau assigns each state AIR with a nationally unique 4-character census code (9000 to 9499) and a nationally unique 8-character GNIS code.

American Indian Trust Lands

American Indian Trust Lands are areas for which the United States holds title in trust for the benefit of a tribe (tribal trust land) or for an individual American Indian tribal member (individual trust land or allotment). Trust lands may be located on (on-reservation) or off an AIR (off-reservation). The Census Bureau recognizes and tabulates data for reservations and ORTLs because American Indian tribes have governmental authority over these lands. Tribal governmental authority generally applies to lands located off the reservation only when the lands are in trust status. In Census Bureau data tabulations, ORTLs are always associated with a specific federally recognized reservation and/or tribal government. A tribal government appointed liaison provides the name and boundaries of their ORTLs. The Census Bureau

does not identify on-reservation trust land, fee land (or land in fee simple status), or restricted fee lands as specific geographic categories and are not identified in the TIGER/Line Shapefiles.

Hawaiian Home Lands (HHLs)

HHLs are areas held in trust for Native Hawaiians by Hawaii (Hawaiian Homes Commission Act of 1920, as amended). The Hawaii Admission Act (a compact between the federal government and Hawaii in 1959) vested land title and responsibility for the program with the State. An HHL is (not a governmental unit) a tract of land with a legally defined boundary that is owned by the state, which, as authorized by the Act, may lease to one or more Native Hawaiians for residential, agricultural, commercial, industrial, pastoral and/or any other activities authorized by state law. The Census Bureau obtains the names and boundaries for HHLs from State officials. The names of the HHLs are based on the traditional ahupua'a names of the Crown and government lands of the Kingdom of Hawaii from which the lands were designated or from the local name for an area.

HHLs are equivalent to ORTL areas with an AIANNH area trust land indicator coded as "T". Census Bureau assigns each HHL area with a nationally unique 4-character census code (5000 to 5499) in alphabetical sequence of each HHL name. Each HHL has a 5-character FIPS code in alphabetical order within Hawaii and a nationally unique 8-character GNIS code.

Joint-Use Areas (Legal)

Joint-Use Areas (Legal) designate land administered jointly and/or claimed by two or more federally recognized American Indian tribes. The Census Bureau designates legal joint-use areas as unique geographic entities for presenting statistical data. Census Bureau assigns each Joint-Use Area with a nationally unique 4-character census code (4800 to 4999) and a nationally unique 8-character GNIS code.

4.1.2.2 Statistical Entity Definitions

Alaska Native Village Statistical Areas (ANVSAs)

ANVSAs are a statistical geographic entity that represents the residences, permanent and/or seasonal, for Alaska Natives who are members of or are primarily receiving governmental services from the defining Alaska Native Village (ANV) and that are located within the region and vicinity of the ANV's historic and/or traditional location. ANVSAs represent the relatively densely settled portion of each ANV and ideally include only an area where Alaska Natives, especially members of the defining ANV, represent a significant proportion of the population during one season of the year (three consecutive months). Officials of the ANV delineated or reviewed ANVSA boundaries. If no ANV official chose to participate in the delineation process, officials of the non-profit ANRC, in which the ANV is located, delineated or reviewed the boundaries. In some cases, if neither the ANV nor ANRC official chose to participate in the delineation process, the Census Bureau reviewed and delineated the ANVSA. An ANVSA may not overlap the boundary of another ANVSA or an AIR.

Census Bureau assigns each ANVSA with a nationally unique 4-character census code (6000 to 7999) based on the alphabetical sequence of each ANVSA's name and a nationally unique 8-character GNIS code.

Joint-Use Areas (Statistical)

Joint-Use Areas (Statistical) designate land administered jointly and/or claimed by two or more American Indian tribes and only apply to overlapping OTSAs. The Census Bureau designates statistical joint-use

areas as unique geographic entities for presenting statistical data. OTSA Joint-use areas have a nationally unique 4-character census code (5900 to 5999) and a nationally unique 8-character GNIS code.

Oklahoma Tribal Statistical Areas (OTSAs)

OTSAs are statistical entities identified and delineated by the Census Bureau in consultation with federally recognized American Indian tribes that formerly had a reservation in Oklahoma. The boundary of an OTSA is generally that of the former reservation in Oklahoma, except where modified by agreements with neighboring federally recognized tribes that are eligible to delineate an OTSA. Tribal subdivisions can exist within the statistical Oklahoma tribal statistical areas. Census Bureau assigns each OTSA with a nationally unique 4-character census code (5500 to 5899) based on the alphabetical sequence of each OTSA's name and a nationally unique 8-character GNIS code.

State Designated Tribal Statistical Areas (SDTSAs)

SDTSAs are statistical entities for state-recognized American Indian tribes that do not have a state-recognized reservation. State liaisons chosen by the governor's office in each state identify and delineate SDTSAs for the Census Bureau. SDTSAs are generally a compact and contiguous area that contains a concentration of people who identify with a state-recognized American Indian tribe and in which there is structured or organized tribal activity. An SDTSA may not be located in more than one state unless both states recognize the tribe and may not include area within any other AIANNH areas. Note that for Census 2000 these areas were termed State Designated American Indian Statistical Areas (SDAISAs); SDTSAs bring consistency to tribal statistical area terms.

Census Bureau assigns each SDTSA with a nationally unique 4-character census code (9500 to 9998) in alphabetical sequence of SDTSA names nationwide and a nationally unique 8-character GNIS code.

Tribal Designated Statistical Areas (TDSAs)

TDSAs are statistical entities identified and delineated for the Census Bureau by federally recognized American Indian tribes that do not currently have a reservation or ORTL. A TDSA should be comparable to AIRs within the same state and/or region, especially for tribes that are of similar size. A TDSA is generally a compact and contiguous area that contains a concentration of individuals who identify with the delineating federally recognized American Indian tribe and in which there is structured or organized tribal activity. A TDSA may be located in more than one state but may not include area within any other AIANNH areas. Census Bureau assigns each TDSA with a nationally unique 4-character census code (8000 to 8999) in alphabetical sequence of TDSA names nationwide and a nationally unique 8-character GNIS code.

The AIANNH codes are in the TIGER/Line Shapefiles with a 4-character census code field, and a single alphabetic character AIANNH area reservation/statistical area or ORTL indicator field, shown as Component Type (COMPTYP). The census codes are in alphabetical order in assigned ranges by AIANNH area type nationwide, except that joint-use areas appear at the end of their applicable code range. There is also a nationally unique 8-character GNIS code. ORTLs have the same code assigned as the associated reservation. ORTLs associated with tribes that do not have a reservation have codes assigned based on their tribal name. There is one record created for each unique combination of AIANNH code and component type.

The type of AIANNH area can be identified either by census code (AIANNHCE), MAF/Tiger Feature Class Code (MTFCC), or FIPS class code (CLASSFP). The range of census codes allocated to each AIANNH area and the valid FIPS class code(s) associated with each are in Figure 7.

Type	Census Code Range	Valid FIPS Class Codes	MTFCCs
Federal American Indian Reservation (AIR) or Off-Reservation Trust Land (ORTL)	0001 to 4799	D1, D2, D3	G2100
Federal AIR or ORTL joint-use area	4800 to 4989	D0	G2170
Hawaiian home land (HHL)	5000 to 5499	F1	G2120
Oklahoma Tribal Statistical Areas (OTSA)	5500 to 5899	D6	G2140
OTSA joint-use area	5900 to 5999	D0	G2170
Alaska Native Village Statistical Area (ANVSA)	6000 to 7999	E1	G2130
Tribal Designated Statistical Area (TDSA)	8000 to 8999	D6	G2160
State AIR	9000 to 9499	D4	G2100
State Designated Tribal Statistical Areas (SDTSA)	9500 to 9998	D9	G2150

Figure 7: Census Codes for each AIANNH area

Notes:

- MTFCC G2100 can represent both federally and state-recognized areas (see Figure 8).

Type	Federal/State Recognition Flag (AIANNHR)
Federally recognized	F
State recognized	S

Figure 8: AIANNHR Recognition Flag

- MTFCC G2170 are Joint-use areas (see Figure 9).

Type	Functional Status (FUNCSTAT)
Federally AIR/ORTL joint-use areas	A
OTSA joint-use areas	S

Figure 9: Functional Status for G2170 joint use areas

- FIPS Class Codes for Federal AIRs or ORTLs (see Figure 10):

FIPS Class Codes	Description
D1	Legal federally recognized American Indian area consisting of reservation and associated Off-Reservation Trust Land.
D2	Legal federally recognized American Indian area consisting of reservation only.
D3	Legal federally recognized American Indian area consisting of Off-Reservation Trust Land only.

Figure 10: FIPS Class Codes for Federal AIRS or ORTLs

Type	Component Type (COMPTYP)
American Indian Trust Land	T
Reservation or Statistical Entity	R

Figure 11: Component types for AIANNH areas

See [Appendix F-2 for AIANNH record layout](#).

4.1.3 American Indian Tribal Subdivisions

American Indian Tribal Subdivision geography and attributes are available in the following shapefile:

American Indian Tribal Subdivision (AITS) National Shapefile (Current)

AITS are legally defined administrative subdivisions of federally recognized AIRs and/or ORTLs or OTSAs. Tribal Subdivisions are known as additions, administrative areas, areas, chapters, county districts, districts, or segments. These entities are internal units of self-government or administration that serve social, cultural, and/or economic purposes for the American Indians on the reservations, Off-Reservation Trust Lands (ORTLs). The Census Bureau obtains the boundary and name information for tribal subdivisions from the federally recognized tribal governments.

AITS codes are in the TIGER/Line Shapefiles with a 3-character census code and a nationally unique 8-character GNIS code. The Census Bureau assigns the 3-character AITS code alphabetically in order and uniquely within each AIR and/or associated ORTL or OTSA.

See [Appendix F-3 for AITS record layout](#).

4.1.4 Tribal Census Tract

Tribal census tract geography and attributes are available in the following shapefile:

Tribal Census Tract National Shapefile (Current)

Tribal census tracts are relatively small statistical subdivisions of an AIR and/or ORTL defined by federally recognized tribal government officials in partnership with the Census Bureau. While tribal census tracts (and block groups, see below) were delineated in the Tribal Statistical Areas Program (TSAP) in 2010, organizational changes to the PSAP allowed for greater flexibility in the geographies reviewed under that program, and proposed 2020 Decennial changes for tribal statistical geographies were solicited through this venue. Tribal census tracts are conceptually similar and equivalent to standard census tracts. Tribal census tracts may cross state, county, and standard census tract boundaries.

Tribal census tracts generally have 1,200 persons (480 housing units) to 8,000 persons (3,200 housing units), with an optimal size of 4,000 persons (1,600 housing units). AIRs and/or ORTLs that have less than 2,400 persons (960 housing units) will only have one tribal census tract that covers the entire AIR and/or ORTL. AIRs and/or ORTLs with 2,400 (or more) people will have more than one tribal census tract.

A tribal census tract usually covers a contiguous area but, in some cases, may consist of more than one discrete area. Tribal census tracts nest within individually federally recognized AIRs and/or ORTLs. In some cases, an AIR and/or ORTL might be noncontiguous, so the tribal census tracts will be as well.

Tribal Census Tracts Codes—Tribal census tracts have a 4-character basic name/code plus a 2-character suffix (for tribal census tract splits in the future). All tribal census tract suffixes are currently zeroes (00) because the 2010 Census was the first to use this coding and no subsequent splits were performed for 2020. Tribal census tract codes all begin with the letter “T” followed by three digits and the 2-character suffix.

For example:

T00200

Tribal census tract codes have an implied decimal between the basic code and the suffix and are unique within an American Indian Reservation and/or ORTL. The code is in the current Tribal Census Tract Code (TTRACTCE) field.

Tribal Census Tract Names—the tribal census tract code also acts as its name, with the suffix only appended if required. While the TTRACTCE field contains the 6-character code format (including the suffix), the NAME field contains the tribal census tract name as displayed in Census Bureau printed reports and on mapping products. The name will consist of the first four characters (“T” followed by three digits, including any leading or trailing zeroes) and a decimal point followed by the 2-character suffix if the suffix is something other than zeroes (00). When the suffix is only zeroes, the tribal tract decimal point and suffix are absent. For example, tribal census tract code “T01000” has a tribal census tract name of “T010”. The NAMELSAD field includes both the translated legal/statistical area description and the tribal tract name (e.g., “Tribal census tract T010”).

For more information on the PSAP, please visit:

<https://www.census.gov/programs-surveys/decennial-census/about/psap.html>

See [Appendix F-4 for Tribal Census Tract National Record Layout](#).

4.1.5 Tribal Block Group

Tribal block group geography and attributes are available in the following shapefile:

Tribal Block Group National Shapefile (Current)

Tribal block groups are subdivisions of a tribal census tract. For the 2010 Census, federally recognized tribal government officials in the Census Bureau’s TSAP defined tribal block groups. If a tribal government declined to participate in the TSAP, the Census Bureau delineated tribal block groups on the AIR and/or ORTL. As above, for the 2020 Census tribal block group changes were managed through PSAP.

Tribal block groups should contain 600 to 3,000 persons (240 to 1,200 housing units). Many AIRs and/or ORTLs have less than the minimum population thresholds will only have one Tribal block group that covers the entire AIR and/or ORTL.

Unlike standard block groups, the cluster of blocks that comprises each tribal block group will not necessarily begin with the same first digit of their 4-character census block number but may contain blocks from several different standard census block groups.

A tribal block group usually covers a contiguous area but, in some cases, may consist of more than one discrete area. Tribal block groups nest within tribal census tracts and within individual federally recognized AIRs and/or ORTLs. In some cases, an AIR and/or ORTLs might be noncontiguous, so the

tribal block groups are as well. In addition, tribal block group boundaries may cross standard census tract, standard block group, county, and/or state boundaries.

Tribal block groups have unique names within tribal tracts. Tribal block group names and codes are identical and are a single capital letter character from “A” to “K” (except for the letter “I”). No relationship exists between the tribal block group identifier and the numbering of census blocks within the tribal block group. A tribal block group will always be identified in conjunction with the tribal census tract within which it is contained.

For example:

T00100A.

For more information on the 2010 TSAP, please visit
<<https://www.census.gov/programs-surveys/geography/about/partnerships/2010-census-partnerships/tsap.html>>

See [Appendix F-5 for Tribal Block Group Record Layout](#).

4.2 Blocks (Census Block)

Block geography and attributes are available in the following shapefile:

Block State-based Shapefile (2010 Geography)

Block State-based Shapefile (2020 Geography)

Census blocks are statistical areas bounded on all sides by visible features (e.g., streets, roads, streams, and railroad tracks), and by non-visible boundaries (e.g., city, town, township, county limits, and short line-of-sight extensions of streets and roads). Generally, census blocks are small in area (e.g., a block in a city). Census blocks in suburban and rural areas may be large, irregular and bounded by a variety of features (e.g., roads, streams, and/or transmission line rights-of-way). In remote areas, census blocks may encompass hundreds of square miles. Census blocks cover all territory in the United States, Puerto Rico, and the Island areas. Blocks do not cross the boundaries of any entity for which the Census Bureau tabulates data. (See Figures 12 and 13).

Census Block Numbers—Census blocks are numbered uniquely within the boundaries of each state, county, census tract with a 4-character census block number. The first character of the tabulation block number identifies the block group. A block number can only be unique by using the decennial census state (STATEFP<YR>), county (COUNTYFP<YR>), census tract (TRACTCE<YR>), and block (BLOCKCE<YR>)+. There is no consistency in block numbers from census to census.

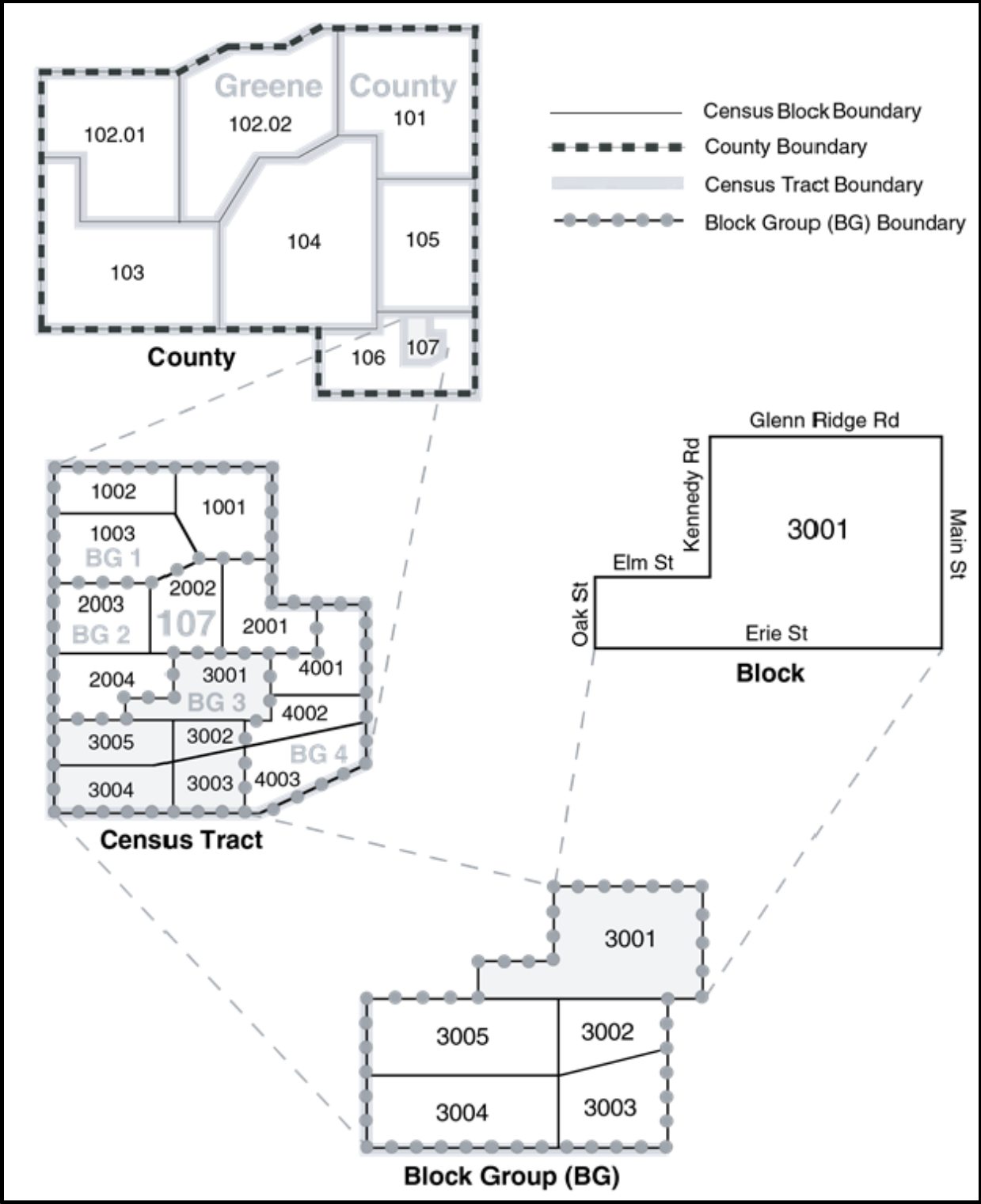

Figure 12: Census Block

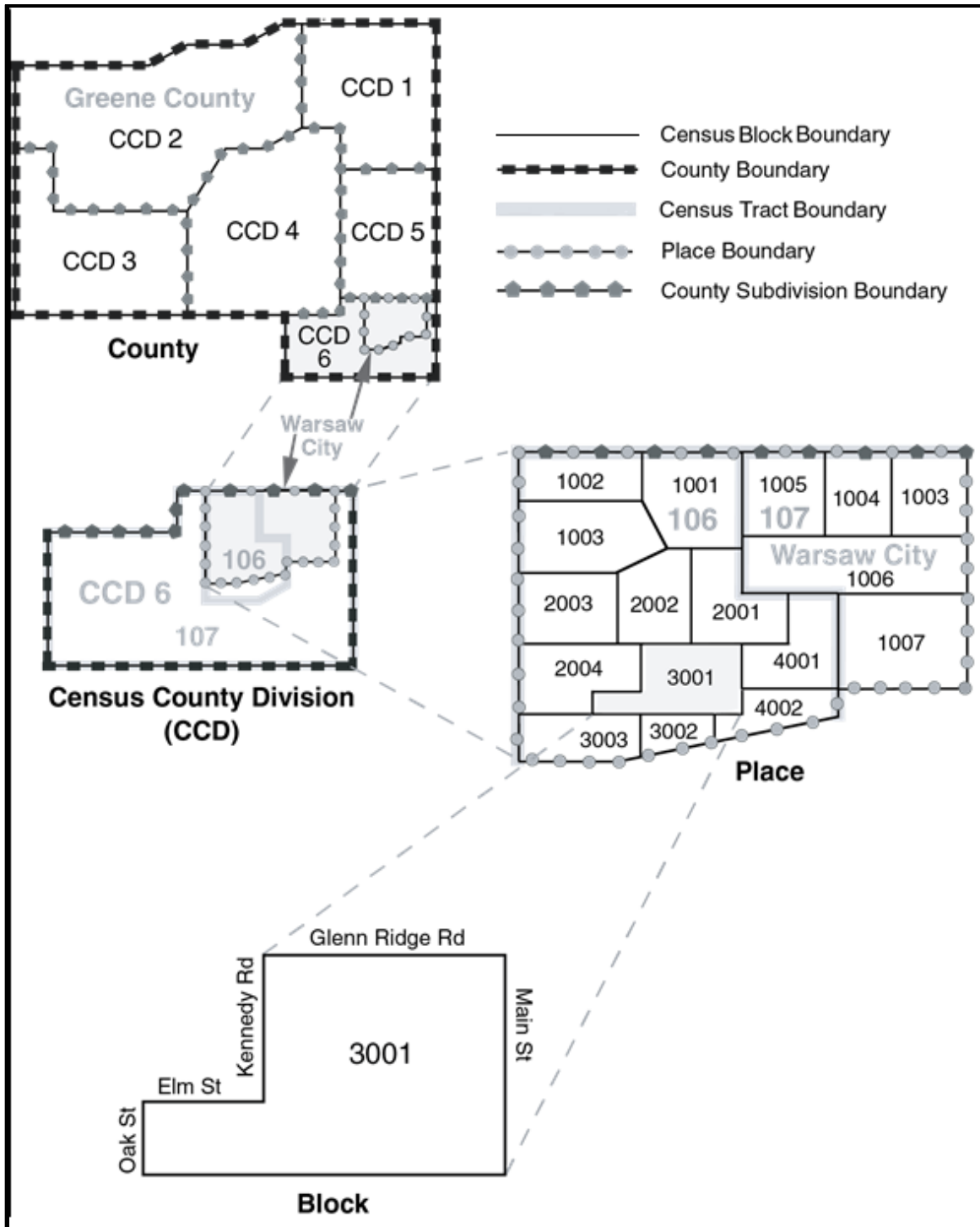

Figure 13: Geographic Relationships: County Subdivision Place Block

See [Appendix K: Block State-based Record Layout](#).

4.3 Block Groups

Block Group geography and attributes are available in the following shapefile:

Block Group State-based Shapefile (Current)

Standard block groups are clusters of blocks within the same census tract that have the same first digit of their 4-character census block number (e.g., Blocks 3001, 3002, 3003 to 3999 in census tract 1210.02 belong to block group 3). Current block groups do not always maintain these same block number to block group relationships due to boundary and feature changes that occur throughout the decade. For example, block 3001 might move due to a change in the census tract boundary. Even if the block is no longer in block group 3, the block number (3001) will not change. However, the GEOID for that block, identifying block group 3, would remain the same in the attribute information in the TIGER/Line shapefiles because block GEOIDs are always built using the decennial geographic codes.

Block groups delineated for the 2020 Census generally contain 600 to 3,000 people. Local participants delineated most block groups as part of the Census Bureau's PSAP. The Census Bureau delineated block groups only where a local or tribal government declined to participate or where the Census Bureau could not identify a potential local participant.

A block group usually covers a contiguous area. Each census tract contains one or more block groups and block groups have unique numbers within census tract. Within the standard census geographic hierarchy, block groups never cross county or census tract boundaries, but may cross the boundaries of county subdivisions, places, urban areas, voting districts, congressional districts, and AIANNH areas.

Block groups have a valid range of zero (0) through nine (9). Block groups beginning with a zero generally are in coastal and Great Lakes water and territorial seas. Rather than extending a census tract boundary into the Great Lakes or out to the 3-mile territorial sea limit, the Census Bureau delineated some census tract boundaries along the shoreline or just offshore.

For more information about the PSAP, please visit:

[<https://www.census.gov/programs-surveys/decennial-census/about/psap.html>](https://www.census.gov/programs-surveys/decennial-census/about/psap.html)

See [Appendix G-2 for Block Group State-based Record Layout](#).

4.4 Census Tracts

Census tract geography and attributes are available in the following shapefile:

Census Tract State-based Shapefile (Current)

Census tracts are small, relatively permanent statistical subdivisions of a county or equivalent entity, and are reviewed and updated by local participants prior to each decennial census as part of the Census Bureau's PSAP. The Census Bureau updates census tracts in situations where no local participant existed or where local or tribal governments declined to participate. The primary purpose of census tracts is to provide a stable set of geographic units for the presentation of decennial census data.

Census tracts generally have a population size of 1,200 to 8,000 people with an optimum size of 4,000 people. The spatial size of census tracts varies widely depending on the density of settlement. Ideally, census tract boundaries remain stable over time to facilitate statistical comparisons from census to census. However, physical changes in street patterns caused by highway construction, new development, and so forth, may require boundary revisions. In addition, significant changes in population may result in splitting or combining census tracts.

Census tract boundaries generally follow visible and identifiable features. Census tract boundaries may follow legal boundaries (e.g., MCD or incorporated place boundaries in some states to allow for census tract-to-governmental unit relationships where the governmental boundaries tend to remain unchanged between censuses). State and county boundaries always are census tract boundaries in the standard census geographic hierarchy.

In a few rare instances, a census tract may consist of noncontiguous areas. These noncontiguous areas may occur where the census tracts are coextensive with all or parts of legal entities that are themselves noncontiguous.

Census Tract Codes and Numbers—Census tract numbers have up to a 4-character basic number and may have an optional 2-character suffix:

For example:

1457.02

The census tract numbers (used as names) eliminate any leading zeroes and append a suffix only if required. The 6-digit census tract codes, however, include leading zeroes and have an implied decimal point for the suffix. Census tract codes (000100 to 998999) are unique within a county or equivalent area.

The Census Bureau assigned a census tract code of 9900 to represent census tracts delineated to cover large bodies of water. In addition, census tract codes in the 9400s represent American Indian Areas and codes in the 9800s represent special land use areas.

The Census Bureau uses suffixes to help identify census tract changes for comparison purposes. Local participants have an opportunity to review the existing census tracts before each census. If local participants split a census tract, the split parts usually retain the basic number, but receive different suffixes. In a few counties, local participants request major changes to, and renumbering of, the census tracts. Changes to individual census tract boundaries usually do not result in census tract numbering changes.

Relationship to Other Geographic Entities—Within the standard census geographic hierarchy, census tracts never cross state or county boundaries, but may cross the boundaries of county subdivisions, places, urban areas, voting districts, congressional districts, and AIANNH areas.

Census Tract Numbers and Codes:

- 000100 to 939999 - Basic number range for census tracts
- 940000 to 949999 - American Indian Areas
- 950000 to 979999 - Basic number range for census tracts
- 980000 to 989999 - Special land use areas
- 990000 to 990099 - Basic number range for census tracts in water areas

- 990100 to 998900 - Basic number range for census tracts

See [Appendix G-3 for Census Tract State-based record layout](#).

4.5 Congressional Districts

Congressional district geography and attributes are available in the following shapefile:

116th Congressional District National Shapefile

Congressional Districts are the 435 areas from which people elect their voting delegates to the U.S. House of Representatives and the 5 areas with nonvoting delegates from state equivalents (District of Columbia, Puerto Rico, American Samoa, Guam, and U.S. Virgin Islands). After the apportionment of congressional seats among the states based on decennial census population counts, each state is responsible for establishing the boundaries of congressional districts. All congressional districts in a state should be as equal in population as is practicable.

The 2020 TIGER/Line Shapefiles contain the 116th Congressional Districts. All congressional districts appearing in the 2020 TIGER/Line Shapefiles reflect the information provided to the Census Bureau by the states by May 1, 2018. The 116th Congressional District shapefile contains the areas in effect from January 2019 to 2021.

Congressional District Codes—Congressional districts have a 2-character FIPS code. Congressional Districts have unique numbers within state.

FIPS Code	Description
01 to 53	Congressional District Codes
98	Nonvoting delegate (District of Columbia, Puerto Rico and the Island Areas)
00	At large (single district for state)

Figure 14: Congressional Districts: FIPS Codes

See [Appendix H for 116th Congressional District Record Layout](#)

4.6 Consolidated Cities

Consolidated city geography and attributes are available in the following shapefile:

Consolidated City State-based Shapefile (Current)

A consolidated government is a unit of local government for which the functions of an incorporated place and its county or MCD have merged. This action results in both the primary incorporated place and the county or MCD continuing to exist as legal entities, even though the county or MCD performs few (or no) governmental functions and has few (or no) elected officials. When one or more other incorporated places in the county or MCD is included in the consolidated government but continues to function as separate government, the primary incorporated place is referred to as a consolidated city. The Census Bureau

classifies the separately incorporated places within the consolidated city as place entities and creates a separate place (balance) record for the portion of the consolidated city not within any other place. The shapefiles represent consolidated cities with a 5-character numeric FIPS code and an 8-character National Standard (GNIS) code. Consolidated City (Balance) Portions refer to the areas of a consolidated city not included in another separately incorporated place.

For example,

Butte-Silver Bow, MT, is a consolidated city (former Butte city and Silver Bow County) that includes the separately incorporated municipality of Walkerville city. The area of the consolidated city that is not in Walkerville city is assigned to Butte-Silver Bow (balance). The name always includes the “(balance)” identifier. Balance portions of consolidated cities are included in the incorporated place shapefiles.

See [Appendix I-1 for Consolidated City Record Layout](#).

4.7 Counties and Equivalent Entities

County and equivalent entity geography and attributes are available in the following shapefile:

County and Equivalent Entity National Shapefile (Current)

Counties and equivalent entities are primary legal divisions of states. In most states, these entities are termed “counties.” Alaska and the Census Bureau cooperatively delineate these census areas for statistical purposes. In four states (Maryland, Missouri, Nevada, and Virginia), there are one or more incorporated places that are independent of any county organization and thus constitute primary divisions of their states. These incorporated places are also known as independent cities. The Census Bureau treats the following entities as equivalents of counties for purposes of data presentation:

Place	Entity
Alaska	Organized Borough
Alaska (census areas)	Unorganized Borough
District of Columbia	-
Louisiana	Parishes
Maryland	Independent Cities
Missouri	Independent Cities
Nevada	Independent Cities
Virginia	Independent Cities
Puerto Rico	Municipios
American Samoa	Districts and Islands
Guam	-
Commonwealth of Northern Mariana Islands	Municipalities
U.S. Virgin Islands	Islands

Figure 15: County Equivalents

Each county or statistically equivalent entity has a 3-character FIPS code that is unique within a state, and an 8-character ANSI code.

The 2020 TIGER/Line Shapefiles reflect available governmental unit boundaries of the counties and equivalent entities as of January 1, 2019.

Core-based Statistical Area (CBSA) Codes

CBSA Codes – The 2019 County and Equivalent Entity shapefiles also contain fields with codes for Combined Statistical Area, metropolitan or micropolitan statistical area, and metropolitan division. Counties form the building blocks for CBSAs, and a user can merge county records to form these areas without having to acquire the individual CBSA shapefiles.

See [Appendix I-2 County and Equivalent Entity National Record Layout](#).

4.8 County Subdivisions

County subdivision geography and attributes are available in the following shapefile:

County Subdivision State-based Shapefile (Current)

County subdivisions are the primary divisions of counties and their equivalent entities for the reporting of decennial census data (e.g., census county divisions, census subareas, minor civil divisions, and unorganized territories). County subdivisions may represent legal or statistical entities. The shapefiles contain a 5-character FIPS code field for county subdivisions and an 8-character GNIS code.

Legal Entity Definitions

Minor Civil Divisions (MCDs)

MCDs are the primary governmental or administrative divisions of a county in many states. MCDs represent many kinds of legal entities with a wide variety of governmental and/or administrative functions. MCDs include the following areas:

American Indian Reservations	Assessment districts	Barrios	Barrios-pueblo	Boroughs
Census subdistricts	Charter townships	Commissioner districts	Counties	Election districts
Election precincts	Gores	Grants	Locations	Magisterial districts
Parish governing authority districts	Plantations	Precincts	Purchases	Supervisor's districts
Towns	Townships			

Figure 16: MCD areas

The Census Bureau recognizes MCDs in 29 states, Puerto Rico, and the Island areas. The District of Columbia has no primary divisions, and the Census Bureau treats the incorporated place of Washington as an MCD equivalent for statistical purposes. In 23 states, all or some incorporated places are not part of any MCD. These places also serve as primary legal county subdivisions and have a FIPS MCD code that is the same as the FIPS place code. The GNIS codes also match for those entities. In other states, incorporated places are part of the MCDs where located or the pattern is mixed—some incorporated places are independent of MCDs and others are included within one or more MCDs. The MCDs in 12

states (see Figure 17) also serve as general-purpose local governments that generally can perform the same governmental functions as Incorporated Places. The Census Bureau presents data for these MCDs in all products that contain place data.

Connecticut	Maine	Massachusetts	Michigan	Minnesota	New Hampshire
New Jersey	New York	Pennsylvania	Rhode Island	Vermont	Wisconsin

Figure 17: MCD States

In Maine and New York, AIRs exist outside the jurisdiction of any town (MCD) and thus serve as the equivalent of MCDs for purposes of data presentation.

Statistical Entity Definitions

Census County Divisions (CCDs)

CCDs are areas delineated by the Census Bureau in cooperation with state and local officials for statistical purposes (non-governmental units and have no legal functions). CCD boundaries usually follow visible features and, in most cases, coincide with census tract boundaries. The Census Bureau gives each CCD a name based on a place, county, or well-known local name to identify its location. CCDs exist where:

- There are no legally established MCDs
- The legally established MCDs do not have governmental or administrative purposes
- The boundaries of the MCDs change frequently
- The MCDs are not generally known to the public

The Census Bureau has established CCDs for the following 20 states:

Alabama	Arizona	California	Colorado	Delaware
Florida	Georgia	Hawaii	Idaho	Kentucky
Montana	Nevada	New Mexico	Oklahoma	Oregon
South Carolina	Texas	Utah	Washington	Wyoming

Figure 18: Census County Divisions

Census Subareas

Census subareas are statistical subdivisions of boroughs, city and boroughs, municipalities, and census areas. Census areas are the statistical equivalent entities for counties in Alaska. Alaska and the Census Bureau cooperatively delineate the census subareas to serve as the statistical equivalents of MCDs.

Unorganized Territories (UTs)

UTs defined by the Census Bureau in nine MCD states and in American Samoa, where portions of counties or equivalent entities are not included in any legally established MCD or incorporated place. The Census Bureau recognizes such separate pieces of territory as one or more separate county subdivisions for census purposes. Each UT is given a descriptive name, followed by the designation “unorganized

territory” and county subdivision FIPS and GNIS codes. The Census Bureau recognizes UTs in the following states and equivalent areas:

Arkansas	Indiana	Iowa	Maine	Minnesota
New York	North Carolina	North Dakota	South Dakota	

Figure 19: Unorganized Territories

Undefined County Subdivisions

In water bodies, primarily Great Lakes waters and territorial sea, legal county subdivisions do not extend to cover the entire county. For these areas, the Census Bureau created a county subdivision with a FIPS code of 00000 and GNIS code of 00000000 named “county subdivision not defined.” The following states and equivalent areas have these county subdivisions:

Connecticut	Illinois	Indiana	Maine	Massachusetts
Michigan	Minnesota	New Hampshire	New Jersey	New York
Ohio	Pennsylvania	Rhode Island	Wisconsin	Puerto Rico

Figure 20: Undefined County Subdivisions

New England City and Town Area (NECTA) Codes

The county subdivision shapefiles also contain fields with codes for combined New England city and town area, New England city and town area, and New England city and town area division. The NECTAs consist of county subdivisions in New England only and users can merge county subdivision records to form these areas without acquiring the individual NECTA shapefiles.

See [Appendix I-3 County Subdivision State-based Record Layout](#).

4.9 Estates (United States Virgin Islands)

Estate features and attributes are available in the United States Virgin Islands in the following shapefile:

Estate State-based Shapefile (Current)

Estates are subdivisions of the three major islands in the United States Virgin Islands (USVI). The estates have legally defined boundaries and are generally smaller in area than the Census Subdistricts (county subdivisions), but do not necessarily nest within these districts. The boundaries of the estates are primarily those of the former agricultural plantations that existed at the time Denmark transferred the islands to the United States in 1917. The names and boundaries of the estates are in common usage by residents and in government administration. Estate boundaries have been substantially revised for the 2020 Census at the request of the USVI Office of the Lieutenant Governor, effective as of January 1, 2020. The 2010 and 2011 TIGER/Line products contain estate data in the Subminor Civil Division (submcd) shapefiles.

See [Appendix I-4 Estate \(U.S. Virgin Islands Only\) Record Layout](#).

4.10 Hydrography (Area and Linear)

Hydrography features and attributes are available in the following shapefiles:

Area Hydrography County-based Shapefile
Linear Hydrography County-based Shapefile

The area hydrography shapefile contains the geometry and attributes of both perennial and intermittent area hydrography features (e.g., ponds, lakes, oceans, swamps, glaciers, and the area covered by large streams represented as double-line drainage). Single-line drainage water features exist in the all lines shapefile and the linear hydrography shapefile.

The linear hydrography shapefile contains all linear features with Hydrography (“H”) type MTFCCs in the MTDB by county. The Census Bureau provides these shapefiles at a county geographic extent and in linear elemental feature geometry. The linear hydrography shapefile includes streams/rivers, braided streams, canals, ditches, artificial paths and aqueducts. A linear hydrography feature may include edges with both perennial and intermittent persistence.

Single-line drainage water features include artificial path features that run through double-line drainage features (e.g., rivers and streams) and serve as a linear representation of these features. The artificial path features may correspond to those in the USGS National Hydrographic Dataset (NHD). However, in many cases the features do not match NHD equivalent feature and will not carry the NHD metadata codes.

Shorelines for Area Hydrography exist in the all lines shapefiles and have MTFCCs of either “P0002” (shoreline of perennial water feature) or “P0003” (shoreline of intermittent water feature).

See [Appendix J-1 for Area Hydrography County-based Record Layout](#).

See [Appendix J-2 for Linear Hydrography County-based Record Layout](#).

4.11 Landmarks (Area and Point)

Landmark features and attributes are available in the following shapefiles:

Area Landmark State-based Shapefile
Point Landmark State-based Shapefile

The Census Bureau includes landmarks in the MTDB to locate special features and help enumerators during field operations. Some of the more common landmark types include area landmarks (e.g., airports, cemeteries, parks and educational facilities) and point landmarks (e.g., schools and churches).

The Census Bureau adds landmark features to the database on an as-needed basis (and does not attempt to ensure that all instances of a feature were included). The landmarks were not used to build or maintain the 2010 Census address list and the absence of a landmark (e.g., hospital or prison) does not mean that associated living quarters were excluded from the 2020 Census enumeration.

Area landmark and area water features can overlap. For example, a park or other special land-use feature may include a lake or pond. In this case, the polygon covered by the lake or pond belongs to a water feature and a park landmark feature. Other kinds of landmarks can overlap as well. Area landmarks can contain point landmarks, but TIGER/Line Shapefiles do not contain links to these features.

All landmarks have a MTFCC that identifies the type of feature and may or may not have a specific feature name. A full MTFCC list with definitions for the 2020 TIGER/Line Shapefiles is in [Appendix E](#). Each landmark has a unique area landmark identifier (AREAID) or point landmark identifier (POINTID) value.

See [Appendix K-1 for Area Landmark State-based Record Layout](#).

See [Appendix K-2 for Point Landmark State-based Record Layout](#).

4.12 Linear Features

Linear elemental features are the spatial representation of 1-dimensional roads, hydrography, railroads, and other miscellaneous features in the MTDB. A linear elemental feature can span one edge or multiple connecting edges that share a common name and feature classification (MTFCC).

More than one linear elemental feature can share the same edge or group of connected edges. For example, an edge may be associated with a linear feature called Oak Street. This same edge may be one of several edges also associated with another linear feature called State Highway 57. The edge in question has two names: Oak Street and State Highway 57. The Census Bureau designates one of these names as primary and the others as alternates; usually the common street name (Oak Street) will be primary.

The MTDB breaks/ends linear elemental features when the feature name changes. All spelling differences result in a new feature. Features will also break at county boundaries, changes in primary/alternate designation, MTFCC, and gaps in the geometry.

4.12.1 All Lines

Each all lines shapefile describes the universe of edges that bound or are included within a county or equivalent entity. The shapefile describes the geometry of each edge along with descriptive attributes and unique identification numbers. These identification numbers provide the means for linking the edges to alternate features (e.g. their names, address ranges, and adjacent faces).

The all lines features, and attributes are in the following shapefile:

All Lines County-based Shapefile

The all lines shapefile contains visible linear feature edges (e.g., roads, railroads, and hydrography), as well as non-feature edges and non-visible boundaries. Additional attribute data associated with the edges are available in relationship files that users must download separately.

The all lines shapefile contains the geometry and attributes of each topological primitive edge. Each edge has a unique Topological Line Identifier (TLID). An edge's left and right faces are identified by the Topological Faces Identifier on the left side of the edge (TFIDL) and the Topological Faces Identifier on the right side of the edge (TFIDR) attributes, which link to the TFID attribute in the Topological Faces shapefile.

The left and right side of an edge is determined by the order of the points that form the edge. An edge is oriented from the start node to the end node. If a person stands on an edge at the start node and faces the end node, data listed in the fields carrying a right qualifier to the right of the edge. Users can employ GIS software to plot the edges as directional vectors with arrows showing the orientation of edges.

In the MTDB, edges may represent several types of features. The series of feature indicator flags (Hydrography [HYDROFLG], Road [ROADFLG], Rail [RAILFLG] and Other Linear [OLFFLG]) indicate the classes of features that share the edge. For example, a road may have embedded railroad tracks; the corresponding edge will have both the ROADFLG and RAILFLG set. Generally, certain feature types appear together on the same edge:

Feature Type	Description
Road and Rail	Roads with adjacent tracks, tracks embedded in roadways or tracks located in the median
Rail and Other Linear Feature	Rail features located on dams and levees
Road and Other Linear Feature	Road features located on dams and levees

Figure 21: Feature Types

The MTFCC identifies the specific code for the primary feature on the edge. For edges that represent roads in combination with other features, the MTFCC in the all lines shapefile will reflect the road feature.

See [Appendix L-1 for All Lines County-based Record Layout](#).

4.12.2 Coastline

The coastline boundary is available in the following shapefile:

Coastline National Shapefile

The coastline shapefile includes all features within the MTDB class "Coastline," distinguished by the MTFCC of L4150. The coastline shapefile uses the MTDB based on water measurement class for display of statistical information only. The name assigned to each coastline feature is a short form of the name of the large body of water bordered by this coastline feature.

See [Appendix L-2 for Coastline National Record Layout](#).

4.12.3 Roads – Primary, Secondary and All Roads

Linear road features and attributes are available in the following shapefiles:

Primary Roads National Shapefile
 Primary and Secondary Roads State-based Shapefile
 All Roads County-based Shapefile

Primary roads are generally divided limited-access highways within the Federal interstate highway system or under state management. Interchanges and ramps distinguish these roads, and some are toll highways. The primary roads shapefile contains all linear street features with a MTFCC of primary roads (S1100) in the MTDB.

The primary and secondary roads shapefile contains all linear street features with MTFCCs of primary roads (S1100) or secondary roads (S1200) in the MTDB. Secondary roads are main arteries, usually in the U.S. highway, state highway, or county highway system. These roads have one or more lanes of traffic in each direction, may or may not be divided, and usually have at-grade intersections with many other roads and driveways. These roads often have both a local name and a route number.

The all roads shapefile contains all linear street features with Street (“S”) type MTFCCs in the MTDB (e.g., primary roads, secondary roads, local neighborhood roads, rural roads, city streets, vehicular trails [4WD], ramps, service drives, walkways, stairways, alleys and private roads).

The Census Bureau works continuously to improve the accuracy of the features in the MTDB, including a recent focus on highway review. However, some street features may have a misclassified MTFCC. There can be gaps in features in the primary roads or the primary and secondary roads shapefiles, if a segment of the feature was misclassified as a local neighborhood road, rural road, or city street (S1400) instead of a primary road (S1100) or secondary road (S1200).

The all roads shapefile will contain multiple overlapping road segments where a segment is associated with more than one road feature. For example, if a road segment is associated with US Route 36 and State Highway 7 and 28th Street, the all roads shapefile will contain three spatially coincident segments, each with a different name. The all lines shapefile contains the set of unique road segments for each county, along with other linear features. Note that the linear feature address range identifier (LINEARID) field can link the linear features back to the featnames table. From there the TLID can relate the feature back to the all lines shapefile.

See [Appendix L-3.1 Primary Roads National Record Layout](#).

See [Appendix L-3.2 Primary and Secondary Roads State-based Record Layout](#).

See [Appendix L-3.3 All Roads County-based Record Layout](#).

4.12.4 Address Ranges

Linear address range features and attributes are available in the following layer:

Address Range Feature County-based Shapefile

- The address range feature county-based shapefile contains the geospatial edge geometry and attributes of all unsuppressed address ranges for a county or county equivalent area. All the TIGER/Line address range files contain potential address ranges, not individual addresses. Potential ranges include the full range of possible structure numbers even though the actual structures may not exist. The Census Bureau suppresses single-address address ranges in order to maintain the confidentiality of the described addresses as specified by [Title 13](#) of the U.S. Code, and does not currently provide any address ranges for the Island areas.

The address range feature shapefile contains all the address range to street name relationships in the address range feature name relationship file. The address range feature shapefile also contains all possible relationships between the address range county-based relationship file (see [Appendix R-1](#)) and the all lines shapefile. The address range feature shapefile will result in better geocoding match rates compared with using the all lines shapefile. The all lines shapefile only contains the most inclusive address range associated with each side of a street edge and the primary street name assigned to the edge.

See [Appendix L-4 for Address Range Feature County-based Record Layout](#).

4.12.5 Railroads

Linear railroad features and attributes are available in the following layer:

Railroads National Shapefile

The railroad shapefile includes spur lines and rail yards, mass transit rail lines (e.g., carlines, streetcar track, monorail or other mass transit rail), and special purpose rail lines (e.g., cog rail lines, incline rail lines, and trams). The railroad shapefile contains all linear rail features with rail (“R”) type MTFCCs in the MTDB. The Census Bureau provides these shapefiles at a national geographic extent and in a linear elemental feature geometry.

See [Appendix L-5 for Railroads National Record Layout](#).

4.13 Metropolitan and Micropolitan Statistical Areas and Related Statistical Areas

Metropolitan and micropolitan statistical areas and related statistical area geography and attributes are available in the following current shapefiles:

Combined New England City and Town Area (CNECTA) National
Combined Statistical Area (CSA) National
Metropolitan Division National
Core Based Statistical Areas (CBSA) National (Metropolitan and Micropolitan Statistical Areas)
New England City and Town Area (NECTA) National
New England City and Town Area (NECTA) Division National

Figure 22: Metropolitan and Micropolitan Statistical Areas

In March 2020, the U.S. Office of Management and Budget (OMB) announced updates to metropolitan and micropolitan delineations, superseding the delineations published on July 15, 2015, and based on official standards published in the Federal Register on June 28, 2010 ([OMB 17-01](#)). The interagency Metropolitan Area Standards Review Committee developed these standards to provide a nationally consistent set of geographic entities for the United States and Puerto Rico. The OMB has not defined metropolitan or micropolitan geography in the Island areas.

A metropolitan or micropolitan statistical area contains a core area with a substantial population nucleus, as well as adjacent communities having a high degree of economic and social integration with that core. Core Based Statistical Area (CBSA) term became effective in 2000 and refers collectively to metropolitan and micropolitan statistical areas.

Each metropolitan statistical area must have one urbanized area of 50,000 or more inhabitants. Each micropolitan statistical area must have one urban cluster of 10,000 to 49,999 inhabitants. The categorization of CBSAs as either metropolitan or micropolitan statistical areas is based on the population in the most populous (or dominant) core, not the total CBSA population or the total population of all (multiple) cores within the CBSA.

Counties or equivalent entities form the building blocks for metropolitan and micropolitan statistical areas. Central counties are those counties or equivalent entities in which 50 percent of the population resides within urban areas of 10,000 (or more) population, or that contain 5,000 people residing within a single urban area of 10,000 (or more) population. Additional outlying counties that meet specified requirements of commuting to or from the central counties may be included in the CBSA.

In New England (Connecticut, Maine, Massachusetts, New Hampshire, Rhode Island, and Vermont), the OMB has defined an alternative county subdivision (generally city and town) based definition of CBSAs known as New England City and Town Areas (NECTAs). NECTAs have the same criteria as metropolitan

and micropolitan statistical areas (urbanized area of 50,000 [or more] inhabitants or an urban cluster of 10,000 to 49,999 inhabitants).

Combined Statistical Areas (CSAs)

CSAs consist of two or more adjacent CBSAs that have significant employment interchanges. The CBSAs that combine to create a CSA retain separate identities within the larger CSAs. CSAs represent groupings of metropolitan and micropolitan statistical areas and should not be ranked or compared with individual metropolitan and micropolitan statistical areas.

Combined New England City and Town Areas (CNECTAs)

CNECTAs consist of two or more adjacent NECTAs that have significant employment interchanges. The NECTAs that combine to create a CNECTA retain separate identities within the larger combined statistical areas. CNECTAs represent groupings of NECTAs and should not be ranked or compared with individual NECTAs.

Metropolitan Divisions

Metropolitan divisions are smaller groupings of counties or equivalent entities within a metropolitan statistical area that contains a single core with 2.5 million inhabitants. Not all metropolitan statistical areas with urbanized areas of this size will contain metropolitan divisions. A metropolitan division consists of one or more main counties that represent an employment center or centers, plus adjacent counties associated with the main county or counties through commuting ties. Metropolitan divisions represent subdivisions of larger metropolitan statistical areas and should not be ranked or compared with metropolitan and micropolitan statistical areas.

New England City and Town Area (NECTA) Divisions

NECTA Divisions are smaller groupings of cities and towns within a NECTA that contains a single core with 2.5 million inhabitants. A NECTA Division consists of a main city or town that represents an employment center, as well as adjacent cities and towns associated with the main city or town through commuting ties. Each NECTA Division must contain a total population of 100,000 or more. NECTA Divisions represent subdivisions of larger NECTAs and should not be ranked or compared with NECTAs.

OMB designates one or more principal cities within each metropolitan statistical area, micropolitan statistical area, and NECTA. Principal cities can be either incorporated places or CDPs. In addition to identifying the more significant places in each metropolitan and micropolitan statistical area or NECTA in terms of population and employment, principal cities also title metropolitan and micropolitan statistical areas, metropolitan divisions, CSAs, NECTAs, NECTA Divisions, and combined NECTAs. A principal city may be only a part of a place if a portion of that place is outside of the metropolitan statistical area, micropolitan statistical area, or NECTA.

Core Based Statistical Area Codes (CBSA)

CBSAs are the metropolitan statistical areas, micropolitan statistical areas, NECTAs, metropolitan divisions, and NECTA divisions use a 5-character code. The codes for metropolitan and micropolitan statistical areas and metropolitan divisions are in alphabetical order by area title. Metropolitan divisions have a code ending in "4". NECTA and NECTA Division codes are in alphabetical order by area title. NECTA Divisions have a code ending in "4".

Core Based Statistical Area Codes	Length	Range
Metropolitan Statistical Areas	5 digits	10000 to 59999
Metropolitan Divisions	5 digits	10004 to 59994
Micropolitan Statistical Areas	5 digits	10000 to 59999
New England City and Town Area (NECTA)	5 digits	70000 to 79999
NECTA Divisions	5 digits	70004 to 79994
Combined Statistical Areas (CSA)	3 digits	100 to 599
Combined NECTAs	3 digits	700 to 799

Figure 23: CBSA codes

Since CBSA codes are defined nationally, no additional codes are required to provide a unique entity identifier. Since lower level divisions nest within CBSA and CBSAs nest within combined areas, the higher-level codes exist in the record layouts for the subordinate entity types.

The metropolitan and micropolitan statistical area and related statistical area boundaries, names, and codes appearing in the 2020 TIGER/Line Shapefiles are those defined as of March 2020 by the OMB.

For more information, please visit:

<<https://www.census.gov/programs-surveys/metro-micro.html>>

See [Appendix M-1 for Combined New England City and Town Area \(CNECTA\) Record Layout.](#)

See [Appendix M-2 for Combined Statistical Area \(CSA\) Record Layout.](#)

See [Appendix M-3 for Metropolitan Division National Record Layout.](#)

See [Appendix M-4 for Metropolitan Statistical Area \(CBSA\) National Record Layout.](#)

See [Appendix M-5 for New England City and Town Area \(NECTA\) National Record Layout](#)

See [Appendix M-6 for New England City and Town Area \(NECTA\) Division National Record Layout.](#)

4.14 Military Installations

Military installation geography and attributes are available in the following shapefile:

Military Installation National Shapefile

The Census Bureau includes landmarks such as military installations in the MTDB to locate special features and help enumerators during field operations. The Census Bureau adds landmark features to the database on an as-needed basis and does not attempt to ensure that all instances of a particular feature are included. For additional information about area landmarks, please see [Section 4.11, Landmarks \(Area and Point\)](#).

This file does not include the three-point landmarks identified as military installation features in the MTDB. These point landmarks are included in the point landmark shapefile.

Although almost all military installations have assigned 8-character ANSI codes, the Census Bureau has not loaded most of this data into the MTDB. The 2020 military shapefiles contain few values in the ANSICODE field.

See [Appendix N Military Installation National Record Layout](#).

4.15 Places – Incorporated Places and Census Designated Places

Place geography and attributes are available in the following shapefile:

Place State-based Shapefile (Current)

The 2020 TIGER/Line Shapefiles include both Incorporated Places (legal entities) and Census Designated Places (statistical entities).

Incorporated Places

Incorporated places are those reported to the Census Bureau as legally in existence as of January 1, 2020, under the laws of their respective states. An incorporated place provides governmental functions for a concentration of people. Incorporated places may extend across county and county subdivision boundaries, but never across state boundaries. An incorporated place usually is a city, town, village, or borough, but can have other legal descriptions.

Census Designated Places (CDPs)

CDPs are the statistical counterparts of incorporated places. CDPs are settled concentrations of population that are identifiable by name but not legally incorporated under the laws of the state in which the CDPs are located. The Census Bureau defines CDP boundaries in cooperation with local partners as part of the PSAP. CDP boundaries usually coincide with visible features or the boundary of an adjacent Incorporated Place or another legal entity boundary. CDPs have no legal status and do not have officials elected to serve traditional municipal functions. CDP boundaries may change from one decennial census to the next with changes in the settlement pattern; a CDP with the same name as in an earlier census does not necessarily have the same boundary. There are no population size requirements for CDPs. In the nine states of the Northeast (Connecticut, Maine, Massachusetts, New Hampshire, New Jersey, New York, Pennsylvania, Rhode Island, and Vermont) as well as Michigan, Minnesota, and Wisconsin, a CDP may represent a densely settled concentration of population within a town or township; in other instances, a CDP represents an entire town or township.

All places shown in data products for Hawaii are CDPs. The Census Bureau (in an agreement with Hawaii) does not show data separately for the city of Honolulu (coextensive with Honolulu County). Puerto Rico only has CDPs, which are comunidades or zonas urbanas. Guam and the Commonwealth of the Northern Mariana Islands also have only CDPs.

Place Codes

Place Codes—the FIPS place code uniquely identifies a place within a state. If place names are duplicated within a state and represent distinctly different areas, a separate code is assigned to each place name alphabetically by the primary county in which each place is located, or, if both places are in the same county, alphabetically by their legal descriptions (e.g., city before village). All places also have an 8-character GNIS code.

Dependent and Independent Places

Dependent and Independent Places—Depending on the state, incorporated places are either dependent within, or independent of, county subdivisions. Some states contain a mixture of dependent and independent incorporated places. Dependent places are part of the county subdivision; the county subdivision code of the place is the same as that of the underlying county subdivision(s) but is different from the FIPS place code. Independent places are not part of any Minor Civil Division (MCD) and serve as primary county subdivisions. The independent place FIPS code usually is the same as that used for the MCD for the place. The only exception is if the place is independent of the MCDs in a state in which the FIPS MCD codes are in the 90000 range. (The [FIPS code range 90000 to 98999](#) is reserved for CCDs and nonfunctioning MCDs where they cover whole States, whole counties, or their statistically equivalent entities). Then, the FIPS MCD and FIPS place codes will differ. CDPs are always dependent within county subdivisions and all places are dependent within statistical county subdivisions.

Independent Cities

Independent Cities are not part of any surrounding county:
Baltimore city, Maryland
St. Louis city, Missouri
Carson City, Nevada
All cities in Virginia (38)

The Census Bureau treats these cities as equivalent to both counties and MCDs (in MCD states). The FIPS code for St. Louis City is the same as the FIPS county subdivision code. All the others have differing FIPS place and county subdivision codes. At the county level, Independent Cities have a 3-character county code of 500 or higher.

Geographic Corridor

A geographic corridor (formerly called corporate corridor) is a narrow, linear part of an incorporated place (or in a very few instances, another type of legal entity). The geographic corridor includes the street and/or right-of-way or a portion of the street and/or right-of-way within the incorporated place. Geographic corridors do not include structures from the incorporated place (e.g., houses, apartments, or businesses that front along the street or road).

Geographic Limit Offset Boundary

A geographic limit offset boundary (formerly called corporate limit offset boundary) exists where the incorporated place lies on only one side of the street and may include all or part of the street and/or the right-of-way. The geographic limit offset boundary does not include the houses or land that adjoins the side of the street with the geographic limit offset boundary. Two or more geographic limit offset boundaries can be on the same street or right-of-way. Geographic limit offset boundaries use the same map symbology as non-offset boundaries. Figures 24 and 25 depict geographic corridors and geographic limit offsets.

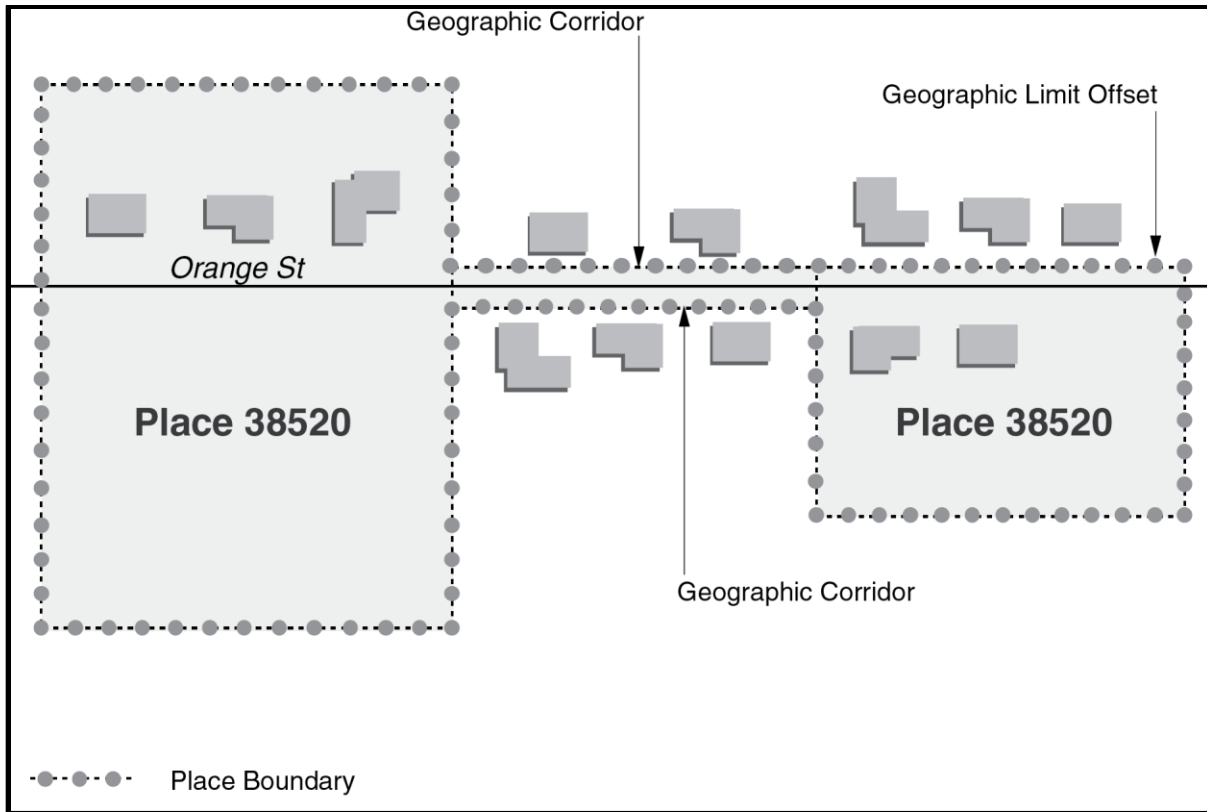

Figure 24: Geographic Corridors - Overview

This diagram (Figure 24), using symbology typical of a census map, shows a geographic corridor linking the two larger areas of Place 38520. Shading highlights the actual area within the corporate limits. Part of the geographic limit along Orange St. is an offset boundary. A geographic limit offset covers only one side of the street or right-of-way, not the entire street or right-of-way, as is the case with a geographic corridor.

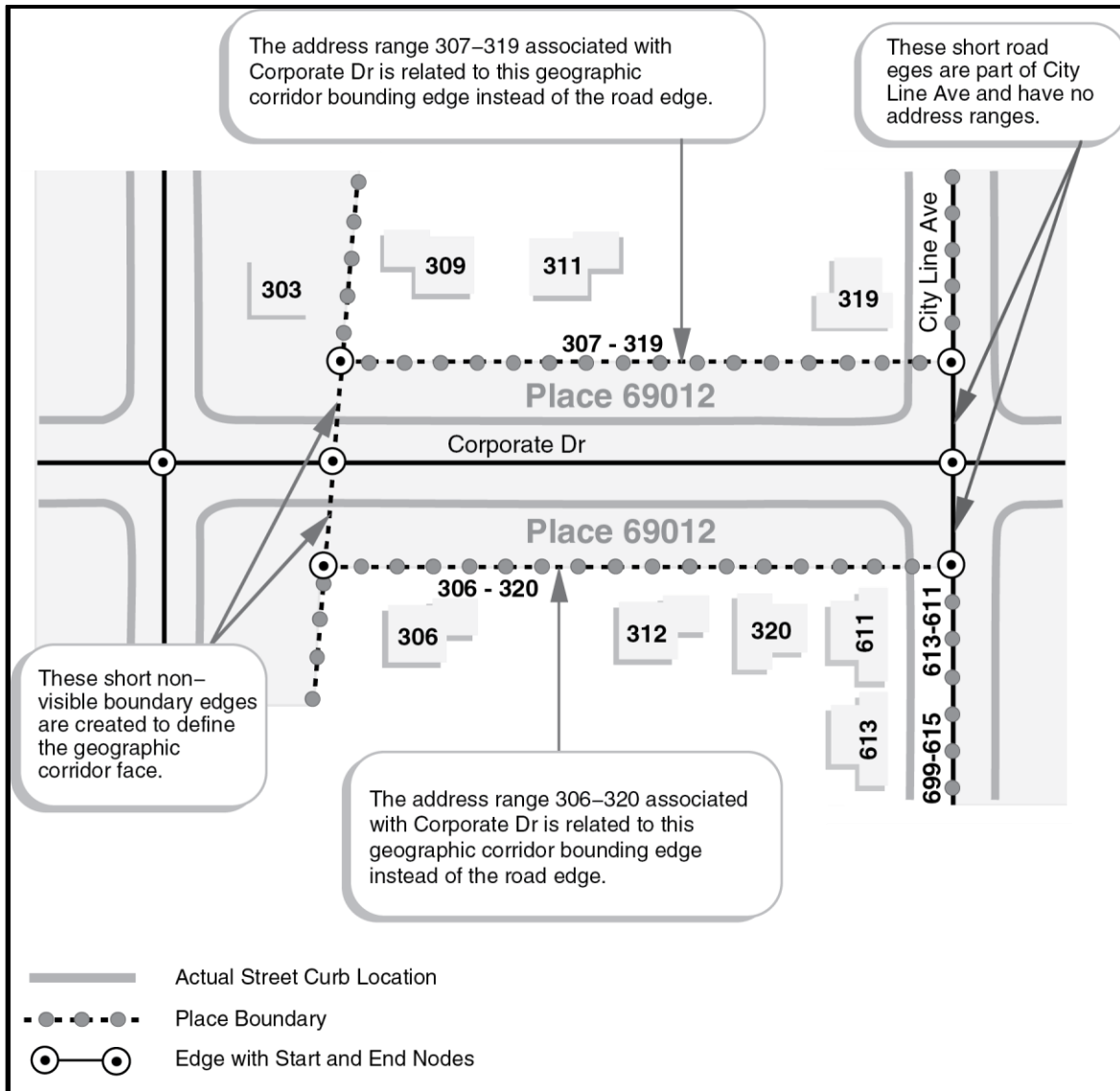

Figure 25: Geographic Corridors Address Ranges

The diagram (Figure 25) shows the address ranges associated with a geographic corridor that runs along Corporate Dr. In order to correctly geocode structures outside the geographic corridor in the correct block and place, the address ranges associated with Corporate Dr. are located on and related to the geographic corridor bounding edge instead of the road edge. For example, 311 Corporate Dr. is located outside the geographic limits. Using address ranges on the road edge for Corporate Dr. will incorrectly geocode the structure to Place 69012. Assigning the address ranges to the geographic corridor edge alongside Corporate Dr. will correctly geocode the structure to the block outside of Place 69012. Note that the geographic corridor edge splits City Line Ave. road edge at one end of the corridor. In this case, the road edge outside of the geographic corridor is the address range and the road edge for City Line Ave. inside the corridor does not have address ranges.

The all lines shapefile and address ranges relationship TLID relate geographic corridor address ranges to the corridor bounding edge adjacent to the road edge. The address range-feature name relationship file relates street names to address ranges on geographic corridor bounding edges. By assigning the address

range to the geographic corridor edge rather than the road edge, structures will geocode correctly outside of the geographic corridor.

Consolidated city (Balance) portions refer to the areas of a consolidated city not included in another separately incorporated place. For example, Butte-Silver Bow, MT, is a consolidated city (former Butte city and Silver Bow County) that includes the separately incorporated municipality of Walkerville city. The area of the consolidated city that is not in Walkerville city is assigned to Butte-Silver Bow (balance). The name always includes the “(balance)” identifier. Balance portions of consolidated cities are included in the place shapefiles.

See [Appendix I-5 Place State-based Record Layout](#).

4.16 Public Use Microdata Areas (PUMAs)

Public Use Microdata Area geography and attributes are available in the following shapefile:

Public Use Microdata Area (PUMA) State-based Shapefile (2010 Census)

PUMAs are decennial census areas that permit the tabulation and dissemination of Public Use Microdata Sample (PUMS) data, American Community Survey (ACS) data, and ACS period estimates.

For the 2010 Census, the State Data Centers (SDCs) in each state, the District of Columbia, and the Commonwealth of Puerto Rico had the opportunity to delineate PUMAs within their state or statistically equivalent entity. All PUMAs must nest within states and have a minimum population threshold of 100,000 persons. 2010 PUMAs consist of census tracts and cover the entirety of the United States, Puerto Rico, Guam, and the U.S. Virgin Islands. The Commonwealth of the Northern Mariana Islands and American Samoa do not contain any 2010 PUMAs because the population is less than the minimum population requirement.

For detailed information about PUMAs, please visit the PUMAs website at:

<<https://www.census.gov/programs-surveys/geography/guidance/geo-areas/pumas.html>>

See [Appendix O-1 Public Use Microdata Area \(PUMA\) State-based Record Layout](#).

4.17 School Districts (Elementary, Secondary, and Unified)

School district geography and attributes are available in the following shapefiles:

Elementary School District State-based Shapefile (Current)

Secondary School District State-based Shapefile (Current)

Unified School District State-based Shapefile (Current)

The Census Bureau obtains school district boundaries, names, local education agency codes, grade ranges, and school district levels annually from state education officials. The Census Bureau collects this information for the primary purpose of providing the U.S. Department of Education with annual estimates of the number of children aged 5 through 17 in families in poverty within each school district, county and state. This information serves as the basis for the Department of Education to determine the annual allocation of Title I funding to states and school districts.

The 2020 TIGER/Line Shapefiles include separate shapefiles for elementary, secondary, and unified school districts. The 2020 shapefiles contain information from the 2020 school year (i.e. districts in operation as of January 1, 2020).

Unified school districts provide education to children of all school ages. In general, if there is a unified school district, no elementary or secondary school district exists (see exceptions described below). If there is an elementary school district, the secondary school district may or may not exist (see explanation below). In addition to regular functioning school districts, the TIGER/Line Shapefiles contain pseudo-school districts as described below.

The Census Bureau categorizes school districts based on the grade ranges for which the school district is financially responsible. These may or may not be the same as the grade ranges that a school district operates. (The grade range that reflects financial responsibility is important for the allocation of Title I funds.) A typical example would be a school district that operates schools for children in grades Kindergarten (KG)-8 and pays a neighboring school district to educate children in grades 9–12. The first school district is operationally responsible for grades KG-8, but financially responsible for grades KG-12. Therefore, the Census Bureau would define the grade range for that school district as KG-12. If an elementary school district is financially responsible for grades KG-12 or Pre-Kindergarten (PK)–12, there will be no secondary school district represented for that area. In cases, where an elementary school district is financially responsible for only lower grades, there is generally a secondary school district that is financially responsible for providing educational services for the upper grades.

The following are exceptions to the above information:

The Census Bureau depicts one unified school district each:

- Hawaii
- Five counties that represent the five boroughs of New York City.

Pseudo-elementary school districts

In the school district shapefiles, Illinois contains pseudo-elementary school districts that represent regular unified school districts in an area where the unified school districts share financial responsibility service with secondary school districts. The Census Bureau created pseudo-elementary school districts linked to the unified school district in order to allocate the elementary school aged children to the unified school district. In this area, there was no regular functioning elementary school district serving the area and the secondary school district in this area was not paying tuition to the unified school district (the secondary school districts' financial responsibilities did not extend to kindergarten).

Pseudo-secondary school districts

In the school district shapefiles, the following states contain pseudo-secondary school districts that represent regular unified school districts in areas where the unified school districts share financial responsibility service with elementary school districts:

California	Georgia	Illinois	Kentucky	Massachusetts
Minnesota	Oklahoma	South Carolina	Tennessee	Texas

Figure 26: School Districts: Pseudo-secondary

The Census Bureau created pseudo-secondary school districts linked to real unified school districts in order to allocate the high school aged children to the unified school districts. In these areas, there were no regular functioning secondary school districts serving the area, and the elementary school districts in these areas were not paying tuition to the unified school districts (the elementary school districts' financial responsibilities did not extend to grade 12).

Pseudo-unified school districts

In the school district shapefiles, New Jersey contains a pseudo-unified school district that represents a regular unified school district, a regular secondary school district, and a regular elementary school district in an area where the unified, secondary, and elementary school districts share financial responsibility service. The Census Bureau created a pseudo-unified school district and linked it to the regular unified, secondary, and elementary school districts in order to allocate the elementary and secondary school aged children to the unified, secondary and elementary school districts.

A list of pseudo-elementary, pseudo-secondary, and pseudo-unified school districts and their codes appears in [Appendix A](#). Pseudo school districts are in the elementary, secondary, and unified school district tables with an 'A' in the school district type (SDTYP) field.

School District Codes

[School District Codes](#)—the 2020 TIGER/Line Shapefiles contain 5-character school district codes. The school district codes are the local education agency codes used by the U.S. Department of Education and are unique within a state. The value 99997 is the school district code assigned to water or land where the state does not define an official school district.

School District Names— the names of school districts include their description and no other field (NAMELSAD) is required.

See [Appendix P-1 Elementary School District State-based Record Layout](#).

See [Appendix P-2 Secondary District State-based Record Layout](#).

See [Appendix P-3 Unified School District State-based Record Layout](#).

4.18 States and State Equivalent Entities

State and equivalent entity geography and attributes are available in the following shapefile:

State and Equivalent Entity National Shapefile (Current)

States and equivalent entities are the primary governmental divisions of the United States. In addition to the fifty states, the Census Bureau treats the District of Columbia, Puerto Rico, and the Island areas (American Samoa, the Commonwealth of the Northern Mariana Islands, Guam, and the U.S. Virgin Islands) as statistical equivalents of states for the purpose of data presentation. Census regions and divisions consist of groupings of states and equivalent entities. Region and division codes are included in the state shapefiles and users can merge state records to form those areas.

See [Appendix P-4 State and Equivalent Entity National Record Layout](#).

4.19 State Legislative Districts (Upper and Lower)

State legislative district geography and attributes are available in the following shapefiles:

State Legislative District Lower Chamber (SLDL) State-based Shapefile (Current)
State Legislative District Upper Chamber (SLDU) State-based Shapefile (Current)

SLDs are the areas in which voters elect a person to represent them in state or equivalent entity legislatures. Most state legislatures consist of upper (senate—SLDU) and lower (house—SLDL) chambers with separate legislative districts. The Census Bureau first reported data for state legislative districts as part of the 2000 Public Law (P.L.) 94-171 Redistricting Data File for the states that chose to submit legislative district boundaries. Starting with the 2010 Census, the Census Bureau updates state legislative district boundaries every two years.

State Legislative Districts (2018 Election Year): All 50 states, plus the District of Columbia and Puerto Rico, participated in Phase 4 of the Census Redistricting Program (part of the P.L. 94-171) and provided the Census Bureau with the 2012 election cycle boundaries, codes, and in some cases names for their state legislative districts. States had the opportunity to provide additional updates to their plans in 2014, 2016 and 2018.

The most recent plans collected by the Census Bureau are the 2018 election year SLDs. The Census Bureau holds the 2018 SLDs until the postcensal state legislative plans for the 2022 state legislatures are collected. Any changes between the 2018 election and the postcensal collection are not reflected in the 2020 TIGER/Line Shapefile products.

A unique 3-character census code (SLD code), identified by state participants, is assigned to each SLDU (senate) and SLDL (house) within a state. The SLD code ZZZ is assigned to areas with no SLDs defined (usually large water bodies) and are a single SLD for purposes of data presentation. The following states contain unassigned SLD (code ZZZ) areas:

Connecticut	Illinois	Louisiana	Maine
Maryland	Massachusetts	Michigan	Ohio
Puerto Rico			

Figure 27: State Legislative Districts

Other Notes on State Legislative Districts

- Nebraska has a unicameral legislature and the District of Columbia has a single council, both of which the Census Bureau treats as upper-chamber legislative areas for the purpose of data presentation. Therefore, there are no data by the lower house of the state legislative districts for either Nebraska or the District of Columbia.
- Ohio generated their state legislative plans using custom geography from the state's Ohio Common and Unified Redistricting Database produced by Cleveland State University. These shapefiles approximate those plans using Census Bureau geography.
- New Hampshire uses flotal districts in their lower-chamber (SLDL) plan. Flotal districts are overlay districts made up of two or more discrete districts. These discrete or component districts are those represented in the New Hampshire SLDL shapefile. A listing of the flotal districts and their component districts is available as a report (pdf) at:
<<https://www2.census.gov/programs-surveys/decennial/rdo/mapping-files/2012/2012-state-legislative-bef/nh-2012-flotal-list.pdf>>

See [Appendix H for records layouts on SLDL and SLDU](#).

4.20 Subbarrio (Subminor Civil Division) (Puerto Rico)

Subbarrio (Subminor civil division - sub-MCD) geography and attributes for Puerto Rico are available in the following shapefile:

Subbarrio (Subminor Civil Division) State-based Shapefile (Current)

Subbarrios, located in Puerto Rico, are legally defined subdivisions MCDs named barrios-pueblo and barrios. Subbarrios do not exist within every MCD in Puerto Rico nor do they necessarily cover the entire area of an MCD where they do exist. The Puerto Rico Planning Board through the Boundary and Annexation Survey (BAS) provided the boundaries of the subbarrios to the Census Bureau. The subbarrio boundaries are as of January 1, 2019. For more information, please visit:

[<https://www.census.gov/programs-surveys/bas.html>](https://www.census.gov/programs-surveys/bas.html)

The 2020 TIGER/Line Shapefiles contain the 5-character FIPS codes for subbarrios and an 8-digit GNIS code.

See [Appendix I-6 Subbarrio \(Subminor Civil Division\) State-based Record Layout](#).

4.21 Topological Faces (Polygons with All Geocodes)

Topological face information is available in the following shapefile:

Topological Faces (Polygons with All Geocodes) County-based Shapefile (Current)

The topological faces shapefile contains the attributes of each topological primitive face. The attributes associated with each face in this shapefile contain both current and 2010 census block information. The Census Bureau created a set of census blocks for the 2010 Census, identified by a 4-digit number with the first digit representing the block group. Throughout the decade, changes to census blocks can occur due to changes in boundaries of the incorporated places, legislative districts, and census tracts that form census block boundaries. The Census Bureau may also split a large census block into more than one piece. All resulting blocks keep the original census block number, followed by a unique alpha character suffix (e.g., block 1001A and 1001B). In a few cases, especially with census tract and block group changes, the first digit in the census block number may no longer represent the current block group.

Due to potential updates to the codes, do not to mix 2010 Census geographic codes with current geographic codes. A block can only be unique by using the decennial census state, county, tract, and block group (STATEFP10 + COUNTYFP10 + TRACTCE10 + BLKGRPCE10) to get the correct block group corresponding to the BLOCKCE or BLOCKCE10. (BLOCKCE10 and BLOCKCE are always identical.) Replacing any of these decennial codes with current codes can lead to false duplicate and/or noncontiguous blocks, as well as state, county, tract, and/or block group changes.

See [Appendix Q Topological Faces \(Polygons with All Geocodes\) County-based Record Layout](#).

4.22 Urban Areas

Urban area geography and attributes are available in the following shapefile:

Urban Area National Shapefile (2010 Census)

For the 2010 Census, the Census Bureau classified all territory, population, and housing units located within Urbanized Areas (UAs) and Urban Clusters (UCs) as urban. The Census Bureau delineates UA and UC boundaries to represent densely developed territory, encompassing residential, commercial, and other non-residential urban land uses. In general, this territory consists of areas of high population density and urban land use resulting in a representation of the urban footprint. Rural areas consist of territory, population, and housing units located outside of UAs and UCs.

For the 2010 Census, the urban and rural classification applied to the 50 States, the District of Columbia, Puerto Rico, and the Island Areas.

Urbanized Areas (UAs) consists of densely developed territory that contains 50,000 (or more) people. The Census Bureau delineates UAs to provide a better separation of urban and rural territory, population, and housing surrounding large places. The Census Bureau first introduced the urbanized area concept for the 1950 Census.

Urban Clusters (UCs) consists of densely developed territory that has 2,500 to 49,999 people. The Census Bureau first introduced the UC concept for the 2000 Census to provide a more consistent and accurate measure of urban population, housing, and territory throughout the United States, Puerto Rico, and the Island Areas. The Census Bureau identifies all qualifying urban areas in Guam, the Commonwealth of the Northern Mariana Islands, and the U.S. Virgin Islands as urban clusters based on agreements with the local governments. Thus, in the Island Areas, urban clusters may exceed 50,000 people.

Urban Area Titles and Codes—The title of each UA and UC may consist of up to three incorporated place or CDP names and will include the 2-letter U.S. Postal Service abbreviation for each state or statistically equivalent entity into which the UA or UC extends. However, if the UA or UC does not contain an incorporated place or CDP, the urban area title will include the single name of an MCD or populated place recognized by GNIS.

Each UC and UA has a 5-character code, based on a national alphabetical sequence of all urban area names. A separate flag is included in data tabulation files to differentiate between UAs and UCs. In printed reports, this differentiation is included in the name.

Relationship to Other Geographic Entities

The Census Bureau delineates urban areas at the block level. Urban areas may cross the boundaries of all other geographic areas for which the Census Bureau presents data, which means that all areas, other than blocks, may include both urban and rural areas.

For more information, visit

<https://www.census.gov/programs-surveys/geography/guidance/geo-areas/urban-rural.html>

4.23 ZIP Code Tabulation Areas (5-digit)

ZIP Code tabulation area geography and attributes are available in the following shapefile:

5-Digit ZIP Code Tabulation Area (ZCTA) National Shapefile (2010 Census)

ZCTAs are approximate area representations of U.S. Postal Service (USPS) 5-digit ZIP Code service areas that the Census Bureau creates using census blocks to present statistical data from censuses and surveys. The Census Bureau defines ZCTAs by allocating each block that contains addresses to a single ZIP Code tabulation area, usually to the ZCTA that reflects the most frequently occurring ZIP Code for the addresses within that block. Blocks that do not contain addresses but that are completely surrounded by a single ZIP Code tabulation area (enclaves) are assigned to the surrounding ZCTA; those surrounded by multiple ZCTAs will be added to a single ZCTA based on the longest shared border. The Census Bureau identifies ZCTAs using a 5-character code that represents the most frequently occurring USPS ZIP Code within that ZCTA. This code may contain leading zeros.

Users should not use ZCTAs to identify the official USPS ZIP Code for mail delivery. The USPS makes periodic changes to ZIP Codes to support more efficient mail delivery. ZIP Codes that cover primarily nonresidential or post office box addresses may not have a corresponding ZCTA because the delineation process uses primarily residential addresses, resulting in a bias towards ZIP Codes used for city-style mail delivery.

For more information on ZCTAs, visit:

<<https://www.census.gov/programs-surveys/geography/guidance/geo-areas/zctas.html>>

See [Appendix O-3 5-digit ZIP Code Tabulation Area \(ZCTA\) National Record Layout](#).

5. Relationship File Concept Overview

Relationships files are database files that provide additional attribute information that users can join to the TIGER/Line Shapefiles. The following sections describe, in alphabetical order, the geographic entity type displayed in each relationship file as well as the record layout for each file.

5.1 Address Ranges

Address range information is available in the following relationship file:

Address Ranges County-based Relationship File

Address ranges fall along an edge side relative to the coded direction of the edge. The 2020 TIGER/Line Shapefiles contain potential address ranges, not individual addresses. Potential ranges include the full range of possible structure numbers even though the actual structures might not exist (see Figure 26).

The address ranges relationship file contains the attributes of each address range. Each address range applies to a single edge side and has a unique address range identifier (ARID) value. A user can determine the edge to which an address range applies by linking the address range to the all lines shapefile using the TLID attribute. Multiple address ranges can apply to the same edge because addresses with different number sequences (e.g., 101, 103, 1622, 1624, etc.) or alphanumeric characters (e.g., N101, N103, S099, S97) can appear along that edge. The most inclusive address range associated with each side of a street edge appears in the all lines shapefile.

The most inclusive address range (not a composite of the available address ranges) has the largest range of potential house number values of all address ranges associated with the side of an edge. The Census Bureau provides the most inclusive address ranges for users looking for data comparable to the address ranges supplied in the Record Type 1 (RT1) of the TIGER/Line data files.

5.1.1 ZIP Codes and Address Ranges

The address numbers used to create address ranges are house number-street name style addresses (or city-style addresses). A house number-street name style address minimally consists of a structure number, street name, and a 5-digit ZIP Code (e.g., 213 Main Street 90210). In the 2020 TIGER/Line Shapefiles, ZIP Codes are only associated to address ranges.

The ZIP Code is an attribute of the address ranges. The address ranges relationship file has a 5-digit ZIP Code field containing a numeric code that may have leading zeroes. Both sides of a street typically have the same ZIP Code, but this is not always true. Different ZIP Codes may serve different sides of a street or cover addresses at each end of a street. Nearly all address ranges will have a ZIP Code, but there are a few instances where unknown ZIP Codes result in null/blank values in the ZIP Code field.

The 2020 TIGER/Line Shapefiles may not contain all street delivery ZIP Codes and may contain some non-delivery ZIP Codes. In some cases, P.O. Box delivery ZIP Codes may be associated with house number-street name style addresses that are not used for mail delivery (see below). The distribution of ZIP Codes in the TIGER/Line Shapefiles may not reflect the exact USPS ZIP Code service area. Likewise, the address range ZIP Codes may not match the ZIP Code Tabulation Area (ZCTA) for the area.

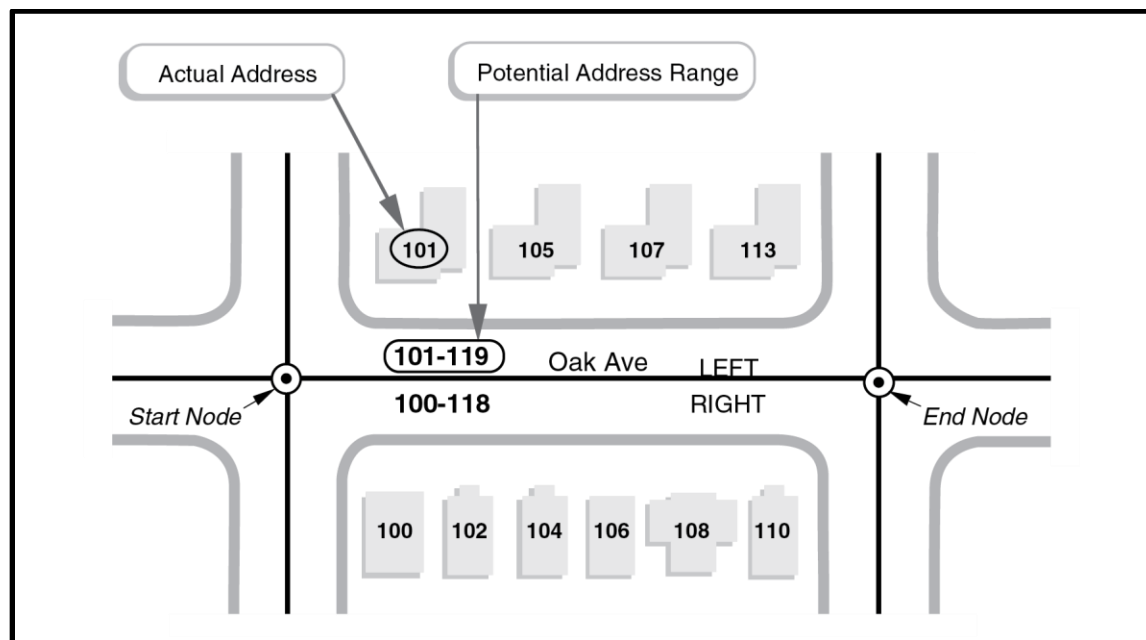

Figure 28: TIGER/Line Shapefiles Address Range Basics

The TIGER/Line Shapefiles contain potential address ranges for city-style addresses. The edge (between the start node and the end node) in the diagram above has two address ranges; the left side has odd-

numbered addresses and the right side has the complementary even-numbered addresses. Potential address ranges along an edge have values that encompass the addresses of existing structures, as well as those not yet built.

Note: The all lines shapefile has the largest range of potential house number values of all address ranges associated with the side on an edge.

Layer Name	Filename	Spatial Data	Address Ranges	Geocoding Usability
All Lines Shapefile	edge.shp	Yes	Most inclusive address ranges	Limited geocoding
Address Range Feature Shapefile	addrfeat.shp	Yes	All address ranges	Best source for geocoding
Address Range Table	addr.dbf	No	All address ranges	No geocoding
Address Range to Feature Name Relationship Table	addrfn.dbf	No	No address ranges	No geocoding

Figure 29: Address Range Product Comparison

Some basic characteristics of address ranges are as follows:

- The 2020 TIGER/Line Shapefiles generally contain address ranges with only house number-street name style addresses. They do not show rural route and post office box addresses. They may contain structure numbers assigned in select areas for use by local emergency services, but not for mail delivery. The 2020 TIGER/Line Shapefiles do include address ranges and ZIP Codes in some small places where the USPS provides only P.O. Box service. These address ranges represent the structure numbers collected during census field operations, supplemented with addresses provided through local participant programs and intercensal Census Bureau activities and updates. These structure-number addresses may have ZIP Codes associated only with P.O. Box addresses. The USPS does not recognize these street addresses as valid mailing addresses and does not assign a ZIP+4 Code to them or include them in the ZIP+4 file. The address ranges may be used to geocode a structure to the census block, but users should be aware of potential conflicts with similar or duplicate mailing street addresses.
- Gaps may exist between multiple ranges for a single edge. A gap may be significant because any numbers missing from one edge may actually appear on another edge. This situation occurs in cases where there are address anomalies (e.g., out-of-parity or out-of-sequence addresses) that cover a single house number. For example, address 709 Main Street is in the middle of the even side of the 700 block of Main Street and suppressed because it is a single address-address range. The following address ranges for the 700 block of Main Street will appear in the 2020 TIGER/Line Shapefiles: 700-798 Main Street, 701-707 Main Street, and 711-799 Main Street. Users cannot tell where 709 Main Street is located based on the information provided. Suppression of single address-address ranges is to protect the confidentiality of individual addresses as specified by [Title 13](#) of the U.S.C.

- Address ranges can include numbers with alphabetic characters. These characters help uniquely identify addresses within a county. For instance, certain unincorporated areas of Genesee County, Michigan, add a letter G prefix to the address number. The characters maintain a consistent column placement within the address range field; for example, the letter G maintains a consistent column placement in the range G1 to G99.
- Some address systems use a hyphen to separate avenue numbers, private road designators, and grid cell numbers from the structure numbers; for example, 10-01 Reynolds St. uses a hyphen to separate the avenue number (i.e., Tenth Avenue) from the structure number. Depending on the locality, the hyphen may be unnecessary for address matching.
- Address ranges exist only for street features, and in some cases, geographic corridor and geographic offset boundary features adjacent to street features. When these boundaries exist, the address ranges move from the street centerline to the boundary to ensure that addresses will geocode to the correct entity.
- Address ranges (consisting of a unique combination of structure number, ZIP Code, feature name, feature type, and directional) should not overlap; addresses should belong to only one address range. The Census Bureau edits address ranges to locate possible overlaps but cannot guarantee that all possible overlap situations are found and have been resolved.
- Address ranges in the 2020 TIGER/Line Shapefiles may be associated with one or more of the street names that belong to an edge. Address range overlap conflicts may occur if the address ranges are associated with some street names or route numbers not intended for use in locating addresses. A route number may traverse several streets with similar house numbers, but different common names used for mail delivery.

5.1.2 Imputed Address Ranges

Imputed address ranges occur during the process of updating the MTDB when a new edge intersects an existing edge with address ranges. The intersection splits the existing edge and produces two new edges connected by a new node located at the intersection point. The update program divides the old address ranges between the two new edges and imputes the address range ends at the new node.

The impute process allocates either all or part of each original address range to each of the new edges in proportion to their lengths (see Figures 28 and 29). For each side of the original edge, the process considers all address ranges appearing on the side and determines the overall low and high addresses. The process assumes addresses have an even distribution along the length of the edge and applies the proportion of edge lengths to the overall address range to calculate a split-point address for each side. Address ranges that fall entirely above or below the split-point address move intact to one of the new edges. The process divides any address ranges that contain the split-point address and allocates each part to one of the new edges. The new address range ends created from the split are imputed values and have the from address range type (FROMTYP) or to address range type (TOTYP) set to imputed value. Some intermediate address range ends also may carry the impute flag. These address range ends fall between the overall high and low address for edge sides that have more than one address range. In current practice, the imputation process will assign the entire address range to one of the edges if the other is very small and would receive only a single address using the proportional division of address ranges.

5.1.3 Geocoding

To get the best match results, the Census Bureau advises users to use the address range feature shapefile (ADDRFEAT.shp) to geo-reference/geocode addresses. Address ranges in the MTDB may separate into multiple address ranges on the same edge (e.g., ZIP Code differences or to establish gaps created by address anomalies located elsewhere). Some address ranges may also include embedded

alphanumeric characters or hyphens that make them distinct from the other address ranges on the same edge side. The ADDRFEAT.shp contains all the address range to edge and street name relationships for a county to increase the number of potential geocoding matches. In comparison, the most inclusive address range in the all line shapefile (EDGES.shp) can also be used for geocoding but a single pair of left and right side address ranges and the primary street name on the edge may not always provide complete address range coverage.

5.1.4 Limitations

Users of the address ranges in the 2020 TIGER/Line Shapefiles should be aware that address range overlaps, gaps, odd/even reversals, and low-high orientation reversals may exist in the data. Apart from overlaps, these may be valid. While the Census Bureau continues to edit and correct data errors, it is possible that some still exist. The Census Bureau defines address ranges on a county-by-county basis. Streets that cross county boundaries may have overlapping address ranges. The Census Bureau is implementing checks to identify and correct these issues. Geocoders often return the address range located in the first county, alphabetically.

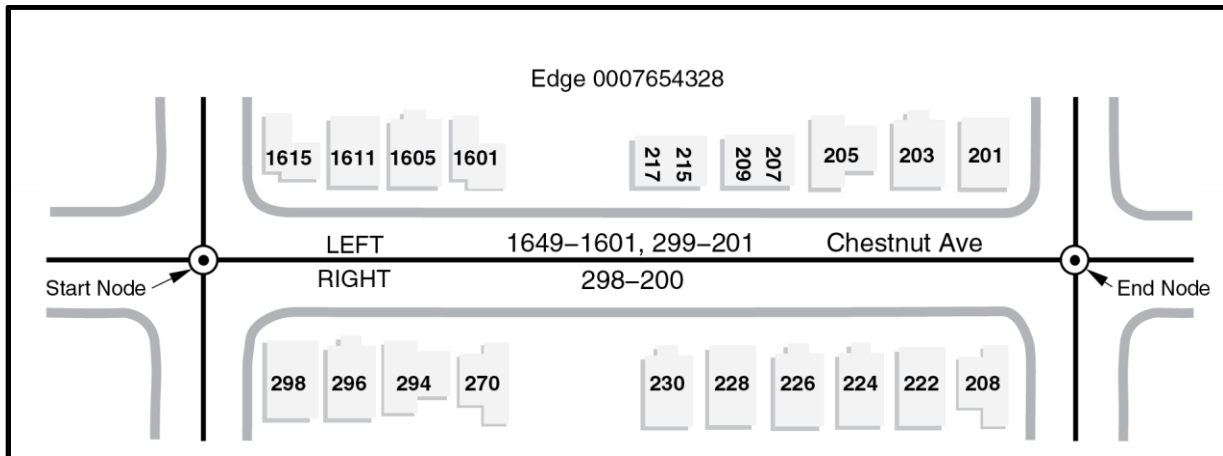

Figure 30: TIGER/Line Shapefile Address Range Imputes - Before Split

The MTDB uses impute flags to indicate that the one or both ends of an address range reflect calculations instead of known values. Imputed address situations generally occur when a new edge splits an edge with existing address ranges. The illustration above shows the address ranges on Chestnut Ave. before a split (see Figure 30).

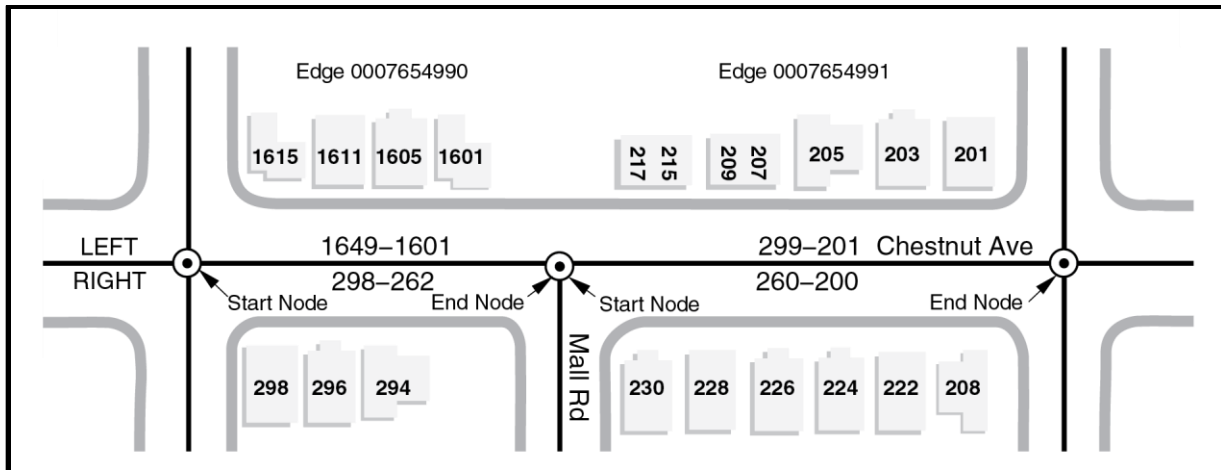

Figure 31: TIGER/Line Shapefile Address Range Imputes - After Split

In the diagram above (see Figure 31), Mail Rd. has split the edge into two parts. The MTDB will assign a new TIGER/Line Identification Number (TLID) to each part and delete the old number. The MTDB next determines the overall address range for each edge side (1649 to 201 on the left side and 298 to 200 on the right side) and the split points for each affected address range (approximately 1088 on the left side and 261 of the right side). Address ranges that fall entirely above or below the split point belong to one of the two new edges and do not get an impute flag. The MTDB divides those address ranges that contain the split point and assigns a part to each of the edges.

See [Appendix R-1 Address Ranges County-based Relationship Record Layout](#).

5.2 Address Range-Feature Name Relationships

Address range-to-feature name relationship information is available in the following relationship file:

Address Range-Feature Name County-based Relationship File

The address range-feature name relationship file contains a record for each address range-linear feature name relationship. The purpose of this relationship file is to identify all street names associated with each address range. An edge can have several feature names and an address range located on an edge can be associated with multiple feature names. A user can link to the address ranges relationship file by using the ARID attribute. The LINEARID attribute identifies the linear feature name and relates the address range back to the Feature Names Relationship File.

See [Appendix R-2 Address Range-Feature Name County-based Relationship Record Layout](#).

5.3 Feature Names

Feature name information is available in the following relationship file:

Feature Names County-based Relationship File

The feature names relationship file contains a record for each feature name-edge combination and includes the feature name attributes. The edge to which a feature names relationship file record applies can be determined by linking to the all lines shapefile using TLID attribute. Multiple feature names relationship table records can link to the same edge.

For example:

A road edge could link to U.S. Hwy 22 and Rathburn Road.

The LINEARID attribute identifies the linear feature to which the feature name applies. Multiple feature names may exist for the same edge. Linear features are not included in the data set, but users can construct them using the all lines shapefile and the relationship tables.

If the edge is both a road and a rail feature, the name associated with the rail feature will carry a rail feature MTFCC. If there are any address ranges on the edge, they apply only to the designated street features.

See [Appendix B Feature Name Directions](#)

See [Appendix C Feature Name Qualifiers](#)

See [Appendix D Feature Name Types](#)

See [Appendix R-3 Feature Names County-based Relationship Record Layout](#)

5.4 Topological Faces-Area Landmark Relationships

Topological faces-to-area landmark relationship information is available in the following relationship file:

Topological Faces-Area Landmark State-based Relationship File

The topological faces-area landmark relationship file contains a record for each face-area landmark relationship. The face to which a topological faces-area landmark relationship file record applies can be determined by linking to the topological faces (polygons with all geocodes) Shapefile using the TFID attribute. The area landmark to which a topological faces-area landmark relationship table record applies can be determined by linking to the area landmark shapefile using the area landmark identifier (AREAID) attribute. A face may be part of multiple area landmarks. An area landmark may consist of multiple faces.

See [Appendix R-4.1 Topological Faces-Area Landmark County-based Relationship File Record Layout](#).

5.5 Topological Faces-Area Hydrography Relationships

Topological faces-to-area hydrography relationship information is available in the following relationship file:

Topological Faces-Area Hydrography County-based Relationship File

The topological faces-area hydrography relationship file contains a record for each face-area hydrography feature relationship. The face to which a topological faces-area hydrography relationship file record applies can be determined by linking to the topological faces (polygons with all geocodes) using the TFID

attribute. The area hydrography feature to which a topological faces-area hydrography relationship file record applies can be determined by linking to the area hydrography shapefile using the area hydrography identifier (HYDROID) attribute. A face may be part of multiple area water features. An area water feature may consist of multiple faces.

See [Appendix R-4.2 Topological Faces-Area Hydrography County-based Relationship Record Layout](#).

5.6 Topological Faces-Military Installation Relationships

Topological faces-to-military installation relationship information is available in the following relationship file:

Topological Faces-Military Installation National Relationship File

The topological faces-military installation relationship file contains a record for each face-military installation relationship. To find out more information about the face the military installation relates to, use TFID in the topological faces (polygons with all geocodes) Shapefile. To determine the military installation the record applies to use the area id (AREAID) attribute found in the military installation shapefile. A military installation feature may consist of multiple faces.

See [Appendix R-4.3 Topological Faces-Military Installation National Relationship Record Layout](#).

6. Instructions for Downloading the TIGER/Line Shapefiles

6.1 Software requirements

To download the shapefiles, you will need:

- Internet Browser or
- File Transfer Protocol (FTP) client,
- Unzipping Utility (e.g. WinZip)

The files downloaded are zipped to save space and ensure you download all the necessary files. Most operating systems have an unzipping utility built-in.

6.2 Getting Started

There are five methods for downloading TIGER/Line Shapefiles from the Census Bureau:

- Website Interface
- Website Interface (FTP Archive)
- Direct from FTP Site
- Connect via FTP Client
- Direct from Data.gov

The examples below are from the 2019 version of the TIGER/Line Shapefiles but apply to all recent TIGER/Line Shapefile versions.

New TIGER/Line Shapefiles are on the census site at:

<<https://www.census.gov/geographies/mapping-files/time-series/geo/tiger-line-file.html>>

Data.gov gets information and links to new TIGER/Line Shapefiles as they become available.

6.3 Website Interface

The Website Interface download method requires the least amount of technical knowledge.

Start at the Census Bureau's TIGER website:

<<https://www.census.gov/geographies/mapping-files/time-series/geo/tiger-line-file.html>>

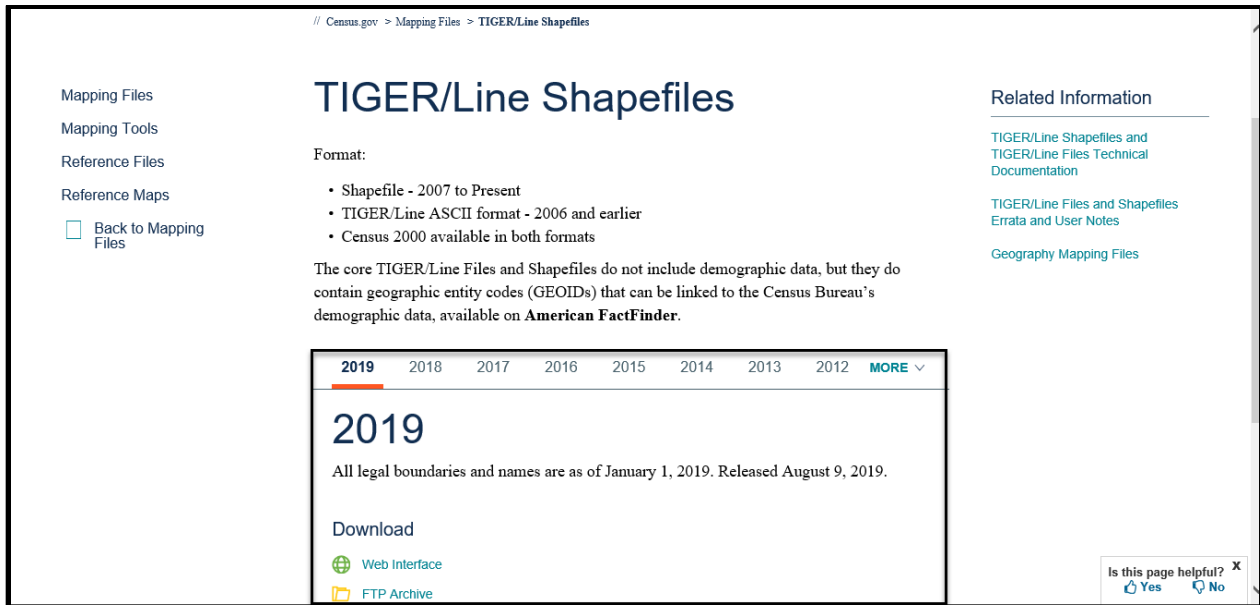

Figure 32: TIGER/Line Shapefiles base screen

Select the tab for the year version of TIGER/Line Shapefiles (e.g., 2019) (See Figure 33 black box).

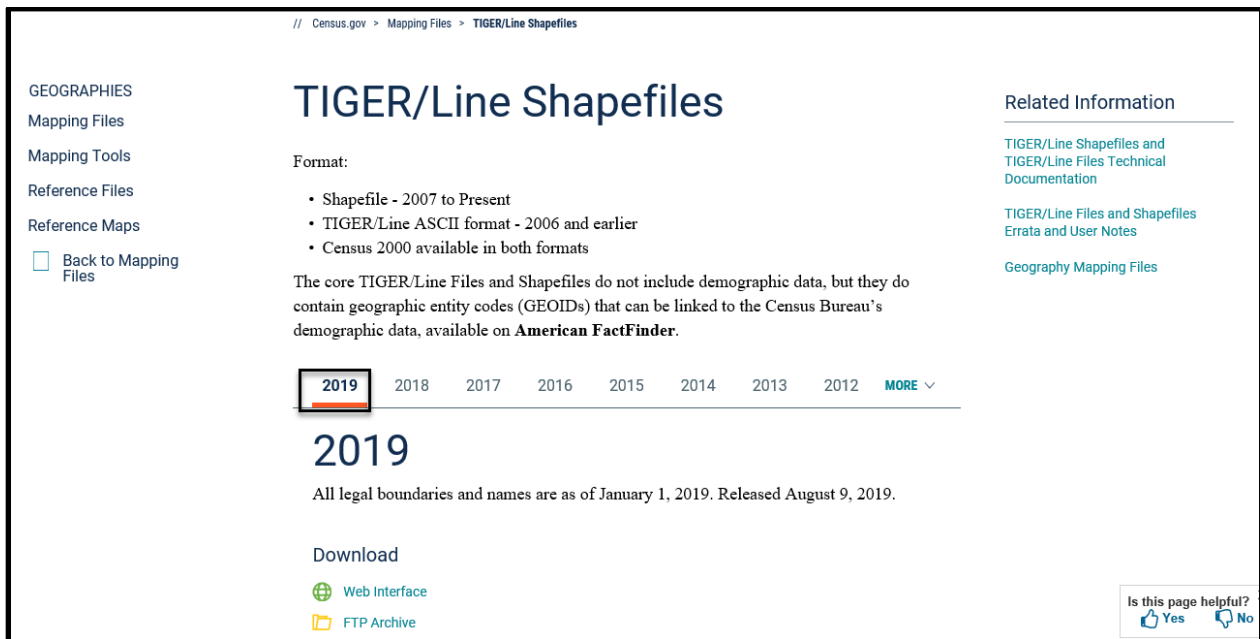

Figure 33: TIGER/Line Shapefiles: Pick Year Version

Click Download, Web Interface (see Figure 34 black box).

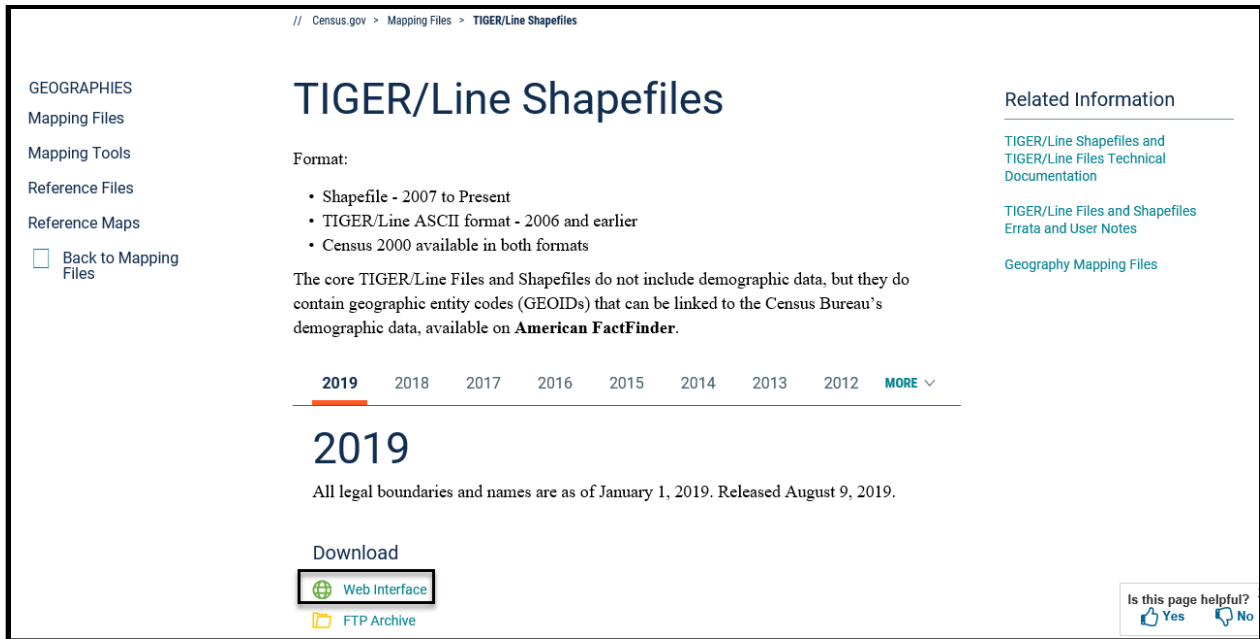

Figure 34: TIGER/Line Shapefiles Selecting Web Interface

Then following screen is shown (see Figure 35)

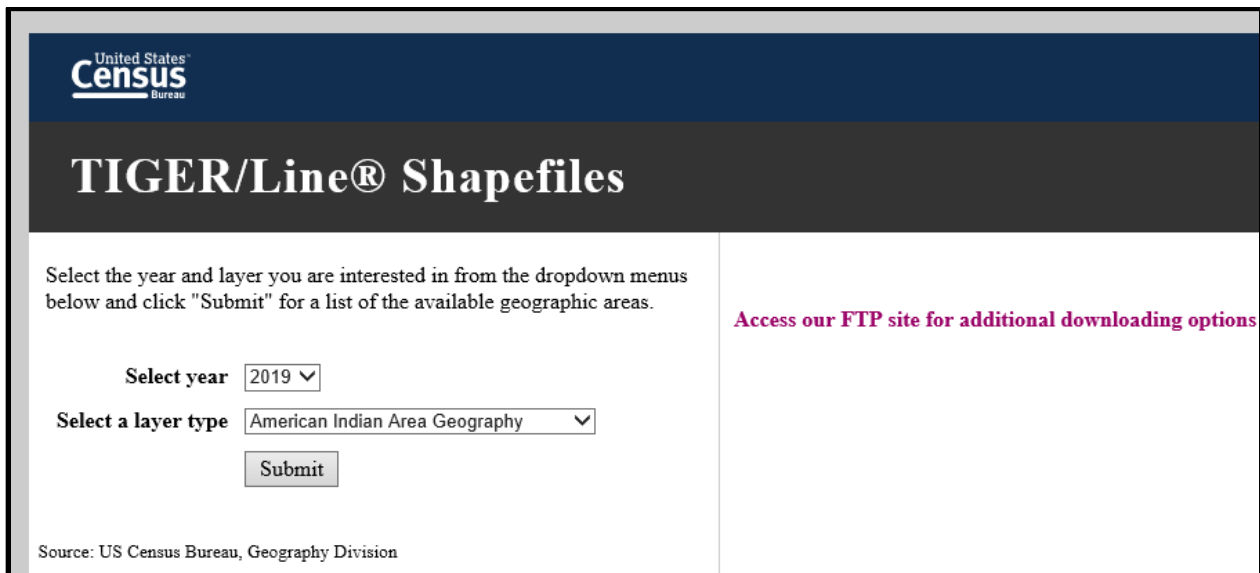

Figure 35: TIGER/Line Shapefiles year and website interface base screen

Different geographies will have different screen options for the download options.

If Submit is pressed, you will see (see Figure 36):



Figure 36: TIGER/Lines Shapefiles menu after submit is pressed

For example: Select American Indian/Alaska Native/Native Hawaiian Area (current) (see Figure 37 black box)

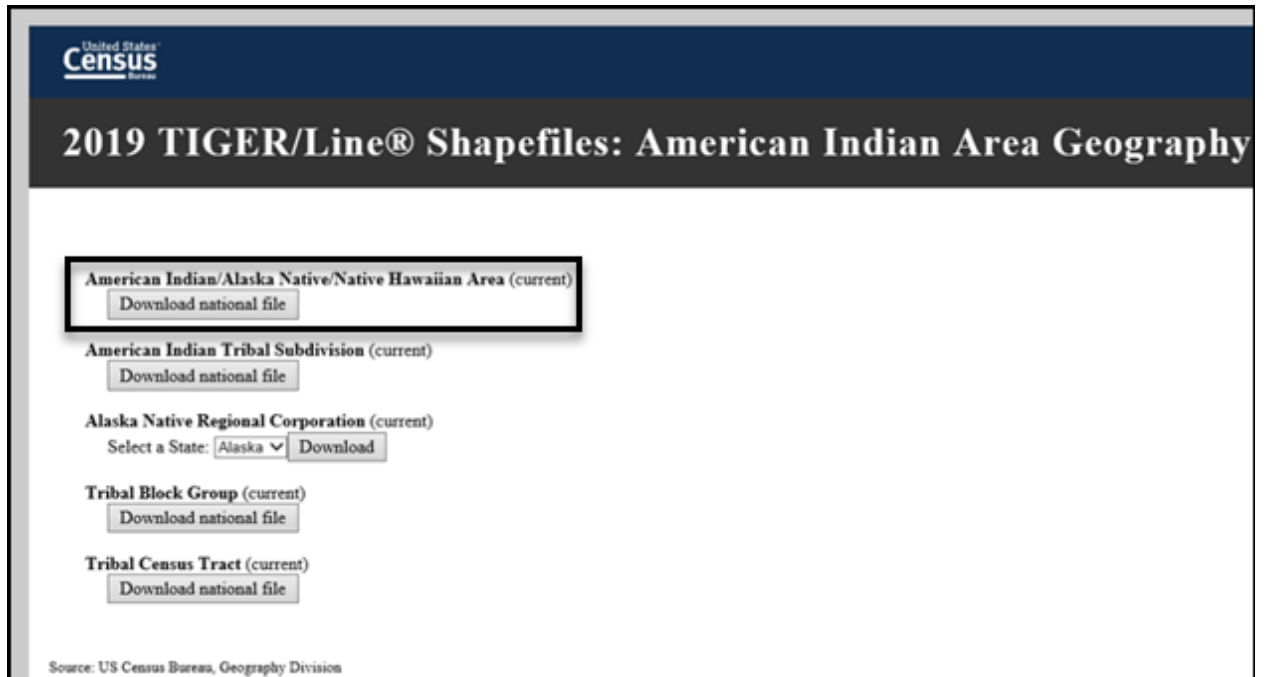

Figure 37: TIGER/LINE Shapefiles selecting American Indian/Alaska Native/Native Hawaiian Area

Then the following box would appear (see Figure 38): (options to open [in browser] or save [or specify its name and file location] or cancel [quit]).



Figure 38: TIGER/Line Shapefiles open, save, cancel options

6.3.1 Geographic Areas by State (or Island Area):

- Alaska Native Regional Corporation (ANRC) (Alaska only)
- Blocks
- Block Groups
- Census Tract
- Consolidated City
- County Subdivisions
- Estates (U.S. Virgin Islands Only)
- Places
- Public Use Microdata Area (PUMA)
- Subbarrios (Subminor Civil Divisions) (Puerto Rico Only)

6.3.2 Features by State:

- All Lines

6.3.3 National Files:

- American Indian Area Geography
 - American Indian, Alaska Native, Native Hawaiian Area
 - American Indian Tribal Subdivision
 - Tribal Block Group
 - Tribal Census Tract
- Congressional Districts
- County and Equivalent
- States and Equivalent
- Urban Areas
- ZIP Code Tabulation Areas (ZCTA5)

6.3.4 National Features:

- Coastlines
- Rails
- Military Installations

6.3.5 Core Based Statistical Areas (CBSA)

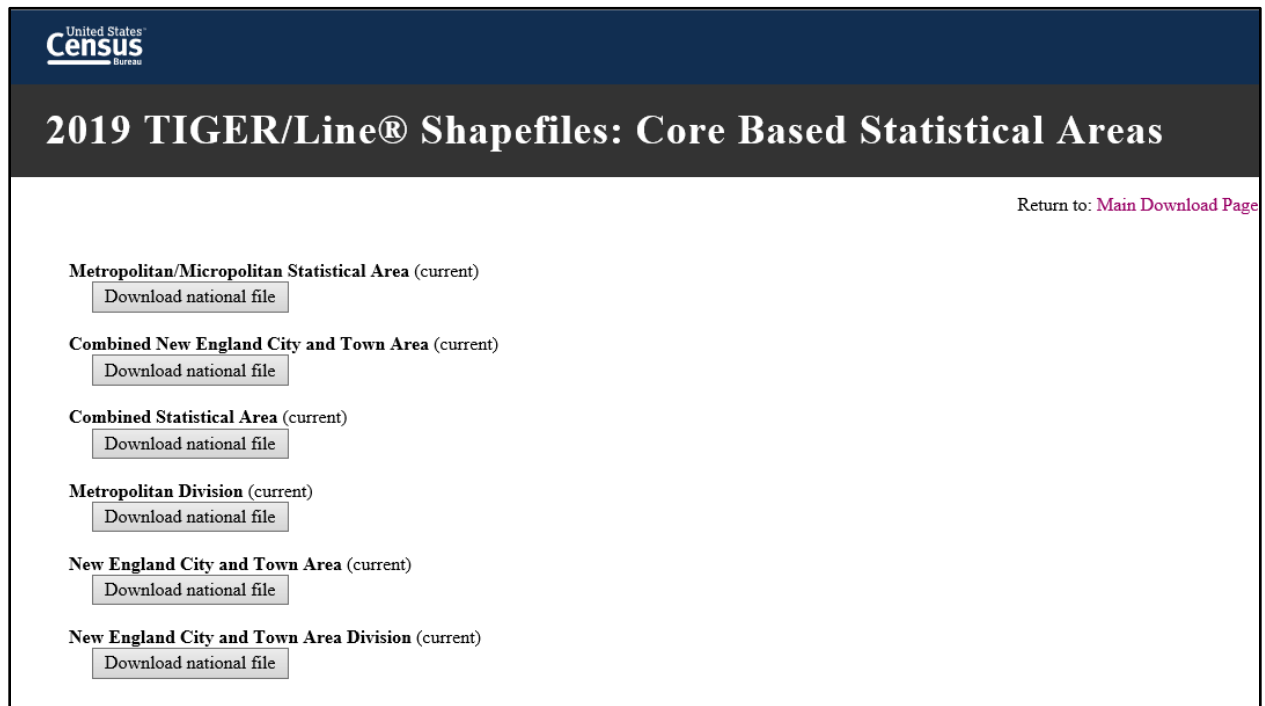

United States
Census
Bureau

2019 TIGER/Line® Shapefiles: Core Based Statistical Areas

[Return to: Main Download Page](#)

Metropolitan/Micropolitan Statistical Area (current)
[Download national file](#)

Combined New England City and Town Area (current)
[Download national file](#)

Combined Statistical Area (current)
[Download national file](#)

Metropolitan Division (current)
[Download national file](#)

New England City and Town Area (current)
[Download national file](#)

New England City and Town Area Division (current)
[Download national file](#)

Figure 39: TIGER/Line Shapefiles Core Based Statistical Areas menu

- Metropolitan/Micropolitan Statistical Area (Current)
- Combined New England City and Town Area (current)
- Combined Statistical Area (current)
- Metropolitan Division (current)
- New England City and Town Area (current)
- New England City and Town Area Division (current)

6.3.6 School Districts

United States
Census
Bureau

2019 TIGER/Line® Shapefiles: School Districts

Return to: [Main Download Page](#)

Elementary School District (current)
Select a State:

Secondary School District (current)
Select a State:

Unified School District (current)
Select a State:

Source: US Census Bureau, Geography Division

Figure 40: TIGER/Line Shapefiles School Districts Menu

- Elementary School District (current)
- Secondary School District (current)
- Unified School District (current)

6.3.7 State Legislative District

United States
Census
Bureau

2019 TIGER/Line® Shapefiles: State Legislative Districts

Return to: [Main Download Page](#)

State Legislative District - Lower Chamber (current)
Select a State:

State Legislative District - Upper Chamber (current)
Select a State:

Source: US Census Bureau, Geography Division

Figure 41: TIGER/Line Shapefiles: State Legislative Districts Menu

- State Legislative District - Lower Chamber (current)
- State Legislative District - Upper Chamber (current)

6.3.8 Features: Landmarks

United States
Census
Bureau

2019 TIGER/Line® Shapefiles: Landmarks

Return to: [Main Download Page](#)

Area Landmark
Select a State:

Point Landmark
Select a State:

Source: US Census Bureau, Geography Division

Figure 42: TIGER/Line Shapefiles: Landmarks Menu

- Area Landmark (State file)
- Point Landmark (State file)

6.3.9 Features: Roads

United States
Census
Bureau

2019 TIGER/Line® Shapefiles: Roads

Primary Roads

Primary and Secondary Roads
Select a State:

All Roads
Select a State:

Source: US Census Bureau, Geography Division

Figure 43: TIGER/Line Shapefiles: Roads Menu

- Primary Roads (National file)

- Primary and Secondary Roads (State file)
- All Roads (State file)

6.3.10 Features: Water

United States
Census
Bureau

2019 TIGER/Line® Shapefiles: Water

Area Hydrography
Select a State:

Linear Hydrography
Select a State:

Source: US Census Bureau, Geography Division

Figure 44: TIGER/Line Shapefiles: Water Menu

- Area Hydrography (State file)
- Linear Hydrography (State file)

6.3.11 Relationship files

United States Census Bureau

2019 TIGER/Line® Shapefiles: Relationship Files

Address Ranges Relationship File
Select a State:

Address Range-Feature Shapefile
Select a State:

Address Range-Feature Name Relationship File
Select a State:

Topological Faces (Polygons with all Geocodes) Shapefile
Select a State:

Topological Faces-Area Hydrography Relationship File
Select a State:

Topological Faces-Area Landmark Relationship File
Select a State:

Topological Faces-Military Installations Relationship File

Feature Names Relationship File
Select a State:

Source: US Census Bureau, Geography Division

Figure 45: TIGER/Line Shapefiles: Relationship Files Menu

- Address Ranges Relationship File (State file)
- Address Range-Feature Shapefile (State file)
- Address Range-Feature Name Relationship File (State file)
- Topological Faces (Polygons with all Geocodes) Shapefile (State file)
- Topological Faces-Area Hydrography Relationship File (State file)
- Topological Faces-Area Landmark Relationship File (State file)
- Topological Faces-Military Installations Relationship File (National file)
- Feature Names Relationship File (State file)

The Connect via FTP Client (6.5) can also be accessed from this screen by pressing the “Access our FTP site for additional downloading options” (See figure 46 black box).

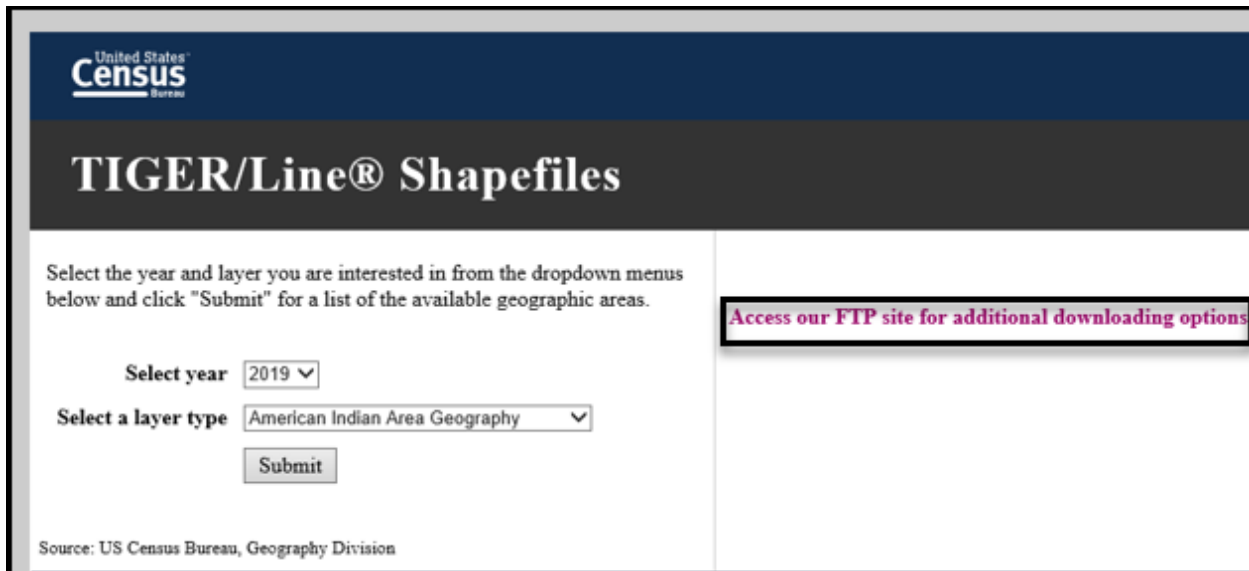

Figure 46: TIGER/Line Shapefiles, FTP site for download

6.4 Web Interface, Archive FTP

Start at the Census Bureau's TIGER website:

<https://www.census.gov/geographies/mapping-files/time-series/geo/tiger-line-file.html>

Then the TIGER/Line Shapefiles menu (Figure 47) will appear.

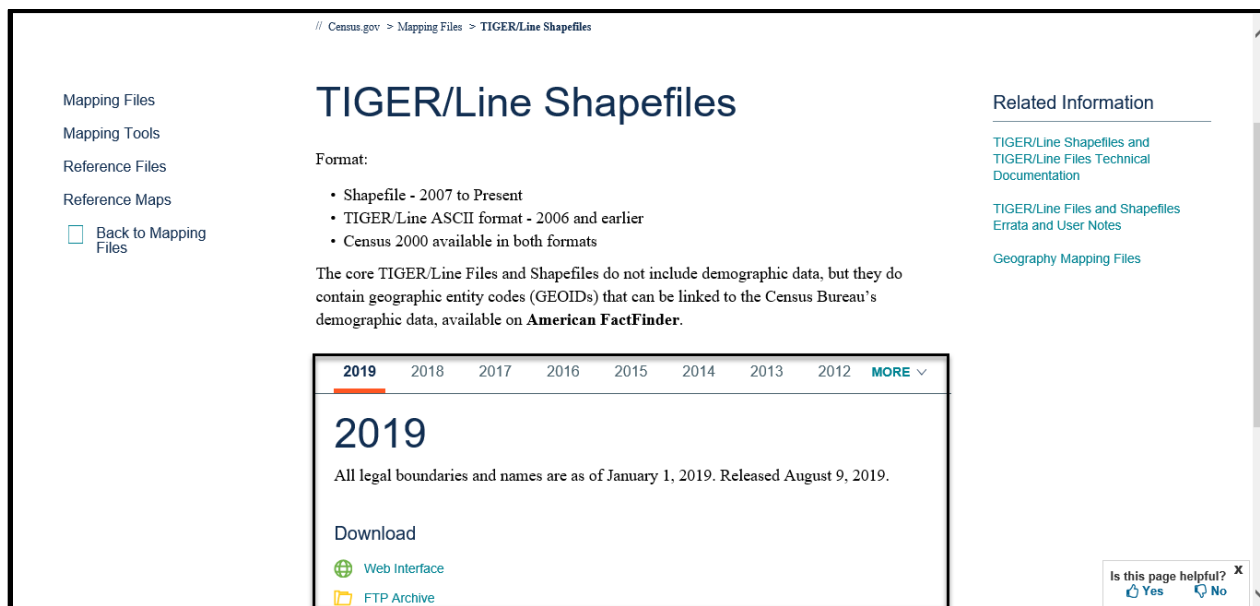

Figure 47: TIGER/Line Shapefiles start menu

Choose FTP Archive (see Figure 48 with black box)

// Census.gov > Mapping Files > TIGER/Line Shapefiles

GEOGRAPHIES

Mapping Files

Mapping Tools

Reference Files

Reference Maps

Back to Mapping Files

TIGER/Line Shapefiles

Format:

- Shapefile - 2007 to Present
- TIGER/Line ASCII format - 2006 and earlier
- Census 2000 available in both formats

The core TIGER/Line Files and Shapefiles do not include demographic data, but they do contain geographic entity codes (GEOIDs) that can be linked to the Census Bureau's demographic data, available on [American FactFinder](#).

Related Information

[TIGER/Line Shapefiles and TIGER/Line Files Technical Documentation](#)

[TIGER/Line Files and Shapefiles Errata and User Notes](#)

[Geography Mapping Files](#)

2019 2018 2017 2016 2015 2014 2013 2012 [MORE](#) ▾

2019

All legal boundaries and names are as of January 1, 2019. Released August 9, 2019.

Download

[Web Interface](#)

[FTP Archive](#)

Is this page helpful?

[Yes](#) [No](#)

Figure 48: TIGER/Line Shapefiles, FTP Archive

Then the following screen will appear (see Figures 49-51)

Name	Last modified	Size	Description
Parent Directory		-	
ADDR/	09-Aug-2019 00:08	-	
ADDRFEAT/	09-Aug-2019 00:08	-	
ADDRFN/	09-Aug-2019 00:08	-	
AIANNH/	09-Aug-2019 00:08	-	
AITSN/	09-Aug-2019 00:08	-	
ANRC/	09-Aug-2019 00:09	-	
AREALM/	09-Aug-2019 00:22	-	
AREAWATER/	09-Aug-2019 00:08	-	
BG/	09-Aug-2019 00:22	-	
CBSA/	09-Aug-2019 00:08	-	
CD/	09-Aug-2019 00:08	-	
CNECTA/	09-Aug-2019 00:08	-	

Figure 49: FTP Archive, Part 1

















 COASTLINE/	09-Aug-2019 00:08	-
 CONCITY/	09-Aug-2019 00:19	-
 COUNTY/	09-Aug-2019 00:08	-
 COUSUB/	09-Aug-2019 00:22	-
 CSA/	09-Aug-2019 00:08	-
 EDGES/	09-Aug-2019 00:08	-
 ELSD/	09-Aug-2019 00:22	-
 ESTATE/	09-Aug-2019 00:22	-
 FACES/	09-Aug-2019 00:08	-
 FACESAH/	09-Aug-2019 00:08	-
 FACESAL/	09-Aug-2019 00:23	-
 FACESMIL/	09-Aug-2019 00:08	-
 FEATNAMES/	09-Aug-2019 00:08	-
 LINEARWATER/	09-Aug-2019 00:08	-
 METDIV/	09-Aug-2019 00:08	-
 MIL/	09-Aug-2019 00:08	-
 NECTA/	09-Aug-2019 00:08	-
 NECTADIV/	09-Aug-2019 00:08	-
 PLACE/	09-Aug-2019 00:23	-
 POINTLM/	09-Aug-2019 00:23	-
 PRIMARYROADS/	09-Aug-2019 00:08	-
 PRISECROADS/	09-Aug-2019 00:23	-
 PUMA/	09-Aug-2019 00:23	-

Figure 50: FTP Archive, Part 2

RAILS/	09-Aug-2019 00:09
ROADS/	09-Aug-2019 00:08
SCSD/	09-Aug-2019 00:21
SLDL/	09-Aug-2019 00:22
SLDU/	09-Aug-2019 00:22
STATE/	09-Aug-2019 00:09
SUBMCD/	09-Aug-2019 00:22
TABBLOCK/	09-Aug-2019 00:23
TBG/	09-Aug-2019 00:09
TRACT/	09-Aug-2019 00:23
TTRACT/	09-Aug-2019 00:09
UAC/	09-Aug-2019 00:09
UNSD/	09-Aug-2019 00:23
ZCTA5/	09-Aug-2019 00:09

Figure 51: FTP Archive, Part 3

Select which entity folder to display (e.g. TRACT) (See Figure 52 with Black box)

TBG/	09-Aug-2019 00:09	-
TRACT/	09-Aug-2019 00:23	-
TTRACT/	09-Aug-2019 00:09	-
UAC/	09-Aug-2019 00:09	-
UNSD/	09-Aug-2019 00:23	-
ZCTA5/	09-Aug-2019 00:09	-

Figure 52: TRACT Selection

The following screen will appear (see Figures 53-55)





















Name	Last modified	Size	Description
 Parent Directory		-	
 tl_2019_01_tract.zip	09-Aug-2019 00:09	9.9M	
 tl_2019_02_tract.zip	09-Aug-2019 00:09	3.0M	
 tl_2019_04_tract.zip	09-Aug-2019 00:10	7.2M	
 tl_2019_05_tract.zip	09-Aug-2019 00:10	8.2M	
 tl_2019_06_tract.zip	09-Aug-2019 00:10	28M	
 tl_2019_08_tract.zip	09-Aug-2019 00:10	7.1M	
 tl_2019_09_tract.zip	09-Aug-2019 00:11	2.5M	
 tl_2019_10_tract.zip	08-Aug-2019 13:37	1.0M	
 tl_2019_11_tract.zip	09-Aug-2019 00:11	353K	
 tl_2019_12_tract.zip	09-Aug-2019 00:11	11M	
 tl_2019_13_tract.zip	09-Aug-2019 00:11	13M	
 tl_2019_15_tract.zip	09-Aug-2019 00:12	1.4M	
 tl_2019_16_tract.zip	09-Aug-2019 00:12	4.0M	
 tl_2019_17_tract.zip	09-Aug-2019 00:12	9.1M	
 tl_2019_18_tract.zip	09-Aug-2019 00:12	5.5M	
 tl_2019_19_tract.zip	09-Aug-2019 00:13	3.8M	
 tl_2019_20_tract.zip	09-Aug-2019 00:13	2.8M	
 tl_2019_21_tract.zip	09-Aug-2019 00:13	11M	
 tl_2019_22_tract.zip	09-Aug-2019 00:13	6.9M	

Figure 53: TRACT individual files, Part 1







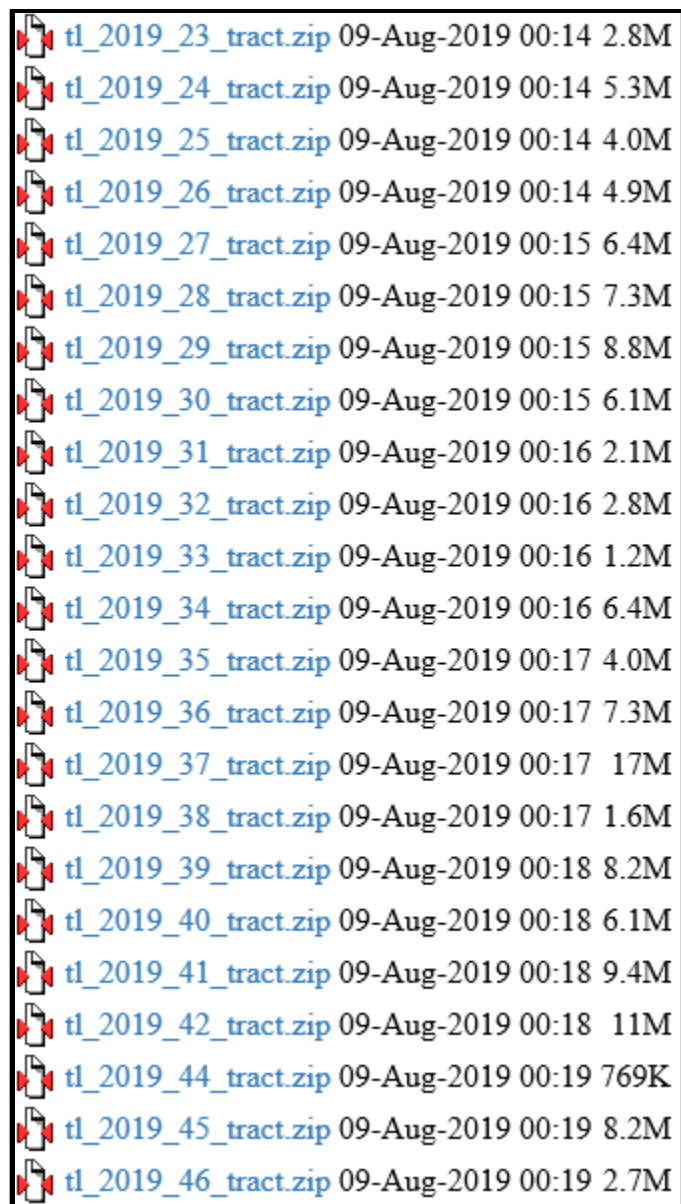

















 tl_2019_23_tract.zip	09-Aug-2019 00:14	2.8M
 tl_2019_24_tract.zip	09-Aug-2019 00:14	5.3M
 tl_2019_25_tract.zip	09-Aug-2019 00:14	4.0M
 tl_2019_26_tract.zip	09-Aug-2019 00:14	4.9M
 tl_2019_27_tract.zip	09-Aug-2019 00:15	6.4M
 tl_2019_28_tract.zip	09-Aug-2019 00:15	7.3M
 tl_2019_29_tract.zip	09-Aug-2019 00:15	8.8M
 tl_2019_30_tract.zip	09-Aug-2019 00:15	6.1M
 tl_2019_31_tract.zip	09-Aug-2019 00:16	2.1M
 tl_2019_32_tract.zip	09-Aug-2019 00:16	2.8M
 tl_2019_33_tract.zip	09-Aug-2019 00:16	1.2M
 tl_2019_34_tract.zip	09-Aug-2019 00:16	6.4M
 tl_2019_35_tract.zip	09-Aug-2019 00:17	4.0M
 tl_2019_36_tract.zip	09-Aug-2019 00:17	7.3M
 tl_2019_37_tract.zip	09-Aug-2019 00:17	17M
 tl_2019_38_tract.zip	09-Aug-2019 00:17	1.6M
 tl_2019_39_tract.zip	09-Aug-2019 00:18	8.2M
 tl_2019_40_tract.zip	09-Aug-2019 00:18	6.1M
 tl_2019_41_tract.zip	09-Aug-2019 00:18	9.4M
 tl_2019_42_tract.zip	09-Aug-2019 00:18	11M
 tl_2019_44_tract.zip	09-Aug-2019 00:19	769K
 tl_2019_45_tract.zip	09-Aug-2019 00:19	8.2M
 tl_2019_46_tract.zip	09-Aug-2019 00:19	2.7M

Figure 54: TRACT individual files, Part 2















	tl_2019_47_tract.zip	09-Aug-2019 00:20	14M
	tl_2019_48_tract.zip	09-Aug-2019 00:20	27M
	tl_2019_49_tract.zip	09-Aug-2019 00:20	4.7M
	tl_2019_50_tract.zip	09-Aug-2019 00:20	630K
	tl_2019_51_tract.zip	09-Aug-2019 00:21	14M
	tl_2019_53_tract.zip	09-Aug-2019 00:21	8.7M
	tl_2019_54_tract.zip	09-Aug-2019 00:21	7.0M
	tl_2019_55_tract.zip	09-Aug-2019 00:21	6.8M
	tl_2019_56_tract.zip	09-Aug-2019 00:22	2.3M
	tl_2019_60_tract.zip	09-Aug-2019 00:22	40K
	tl_2019_66_tract.zip	09-Aug-2019 00:22	541K
	tl_2019_69_tract.zip	09-Aug-2019 00:22	362K
	tl_2019_72_tract.zip	09-Aug-2019 00:22	3.2M
	tl_2019_78_tract.zip	09-Aug-2019 00:23	376K

Figure 55: TRACT individual files, Part 3

Select which tract file to view.

6.5 Direct from FTP Site

Another option is to go directly to the Census Bureau’s File Transfer Protocol (FTP) site through a web browser. The web address for the TIGER/Line Shapefiles is:

<<ftp://ftp2.census.gov/geo/tiger/>> or <<https://www2.census.gov/geo/tiger/>>

- Navigate to the version of the TIGER/Line Shapefiles to download (e.g., TIGER2019). See figure 60.
- Navigate to the geographic entity to download (e.g., TRACT) (see Figure 52). See [Appendix S](#) for the shapefile naming convention.

6.6 Connect via FTP Client

To access a large number of files the best option is to use an FTP client software to connect to the Census Bureau’s FTP site. There are many free FTP clients. The host name must be the Census Bureau’s main FTP site: <<ftp2.census.gov>>

Use “anonymous” for the username and password.

FTP root at ftp2.census.gov

To view this FTP site in File Explorer: press Alt, click **View**, and then click **Open FTP Site in File Explorer**.

Server: ftp2.census.gov

Personal Identifiable Information (PII) shall not be placed on the FTP server without prior special arrangement and in conjunction with ITSO.

NOTE: The data available for anonymous FTP download on this FTP server are also available over the Web:

<http://www2.census.gov>

01/14/2020 04:06PM	Directory	2020Census
01/24/2014 12:00AM	17	AOA
12/19/2018 12:00AM	18	CTPP
12/04/2019 04:00PM	Directory	EEO 2006 2010
06/08/2015 12:00AM	Directory	EEO Disability 2008-2010
04/27/2011 12:00AM	Directory	Econ2001 And Earlier
01/24/2014 12:00AM	17	HUD
10/08/2019 07:12AM	Directory	about
05/24/2015 12:00AM	Directory	acs
09/23/2008 12:00AM	Directory	acs2002
10/06/2004 12:00AM	Directory	acs2003
02/02/2006 12:00AM	Directory	acs2004
11/28/2017 12:00AM	Directory	acs2005
01/24/2014 12:00AM	11	acs2005 2007 3yr
01/24/2014 12:00AM	11	acs2005 2009 5yr
08/25/2015 12:00AM	Directory	acs2006
01/24/2014 12:00AM	11	acs2006 2008 3yr
08/25/2015 12:00AM	Directory	acs2007 1yr
01/24/2014 12:00AM	12	acs2007 2009 3yr
08/25/2015 12:00AM	Directory	acs2007 3yr
08/25/2015 12:00AM	Directory	acs2008 1yr
08/25/2015 12:00AM	Directory	acs2008 3yr
08/25/2015 12:00AM	Directory	acs2009 1yr
08/25/2015 12:00AM	Directory	acs2009 3yr
08/25/2015 12:00AM	Directory	acs2009 5yr
05/02/2015 12:00AM	Directory	acs2010 1

Figure 56: FTP Root, Part 1

05/24/2015 12:00AM	Directory	acs2011 3yr
05/24/2015 12:00AM	Directory	acs2011 5yr
05/24/2015 12:00AM	Directory	acs2012 1yr
05/24/2015 12:00AM	Directory	acs2012 3yr
05/24/2015 12:00AM	Directory	acs2012 5yr
05/24/2015 12:00AM	Directory	acs2013 1yr
05/24/2015 12:00AM	Directory	acs2013 3yr
05/24/2015 12:00AM	Directory	acs2013 5yr
07/22/2016 12:00AM	20	acs latest data
03/31/2008 12:00AM	Directory	acs special tabs
05/23/2019 12:00AM	Directory	adrm
01/06/2014 12:00AM	Directory	aff
02/08/2013 12:00AM	8,347	akamai-sureroute-test-object.htm
12/27/2016 12:00AM	Directory	cac
04/16/2019 12:00AM	Directory	census 1940
04/04/2017 12:00AM	Directory	census 1980
01/11/2017 12:00AM	Directory	census 1990
03/13/2015 12:00AM	Directory	census 2000
05/23/2019 12:00AM	Directory	census 2010
07/10/2019 12:00AM	Directory	ces
10/24/2019 08:44AM	Directory	data
01/28/2019 12:00AM	Directory	decennial
02/25/2013 12:00AM	Directory	doe
01/27/2014 12:00AM	Directory	does
09/29/2014 12:00AM	Directory	dssd
04/18/2016 12:00AM	Directory	econ
06/02/2011 12:00AM	Directory	econ1977
06/02/2011 12:00AM	Directory	econ1982
06/02/2011 12:00AM	Directory	econ1987
04/26/2011 12:00AM	Directory	econ1992
04/13/2011 12:00AM	Directory	econ1997
06/27/2012 12:00AM	Directory	econ2002
06/27/2012 12:00AM	Directory	econ2003
06/27/2012 12:00AM	Directory	econ2004
06/27/2012 12:00AM	Directory	econ2005
06/27/2012 12:00AM	Directory	econ2006
05/14/2013 12:00AM	Directory	econ2007
06/23/2010 12:00AM	Directory	econ2008
06/09/2011 12:00AM	Directory	econ2009
09/25/2012 12:00AM	Directory	econ2010
05/28/2013 12:00AM	Directory	econ2011
09/15/2016 12:00AM	Directory	econ2012
06/06/2017 12:00AM	Directory	econ2013
12/05/2016 12:00AM	Directory	econ2014
05/24/2018 12:00AM	Directory	econ2015
07/11/2019 12:00AM	Directory	econ2016
06/20/2019 12:00AM	Directory	econ2017
01/27/2014 12:00AM	Directory	exist
05/15/2001 12:00AM	318	favicon.ico
02/27/2015 12:00AM	Directory	foia
06/04/2018 12:00AM	Directory	geo
08/23/2016 12:00AM	Directory	govs
10/09/2014 12:00AM	Directory	hhes
01/24/2014 12:00AM	12	inc
01/24/2014 12:00AM	12	incoming
04/26/2017 12:00AM	Directory	indicators
08/06/2019 08:49AM	Directory	library
11/21/2005 12:00AM	Directory	lost+found

Figure 57: FTP Root, Part 2

05/18/2015 12:00AM	Directory	main
11/18/2019 06:08PM	Directory	media
01/27/2014 12:00AM	Directory	mount
11/15/2016 12:00AM	Directory	mtis
11/21/2013 12:00AM	0	mytouch
09/13/2018 12:00AM	Directory	news
01/27/2014 12:00AM	Directory	not
01/24/2014 12:00AM	12	outgoing
07/11/2003 12:00AM	Directory	plmap
09/03/2014 12:00AM	Directory	prod2
01/16/2020 12:36PM	Directory	programs-surveys
03/04/2010 12:00AM	Directory	pub
03/28/2011 12:00AM	0	qwertyuiop.test
05/07/2009 12:00AM	Directory	retail
09/03/2019 12:35PM	478	robots.txt
08/20/2019 03:28PM	993	robots.txt-original
03/28/2012 12:00AM	Directory	sam
01/11/2016 12:00AM	Directory	services
12/15/2017 12:00AM	Directory	software
12/19/2018 12:00AM	17	thu
01/28/2020 06:20AM	Directory	tms_data
10/26/2018 12:00AM	Directory	topics
11/14/2013 12:00AM	Directory	trade
01/30/2009 12:00AM	Directory	w3c
06/09/2017 12:00AM	Directory	wholesale

Figure 58: FTP Root, Part 3

Then, navigate to the GEO (figure 59, black box)

01/27/2014 12:00AM	Directory	exist
05/15/2001 12:00AM	318	favicon.ico
02/27/2015 12:00AM	Directory	foia
06/04/2018 12:00AM	Directory	geo
08/23/2016 12:00AM	Directory	govs
10/09/2014 12:00AM	Directory	hhes

Figure 59: FTP Client, Select GEO

Then select Tiger (see Figure 60 with a black box)

FTP directory /geo/ at ftp2.census.gov

To view this FTP site in File Explorer: press Alt, click View, and then click **Open FTP Site in File Explorer**.

[Up to higher level directory](#)

02/08/2016 12:00AM	Directory	docs
07/24/2019 12:00AM	Directory	img
03/23/2011 12:00AM	Directory	lost+found
07/17/2019 12:00AM	Directory	maps
01/28/2020 10:18AM	0	mytouch
01/12/2015 12:00AM	Directory	pdfs
07/24/2018 12:00AM	Directory	pvs
12/11/2018 12:00AM	Directory	relfiles
06/25/2019 12:00AM	Directory	tiger

Figure 60: FTP Client, Select Tiger

Then the following screen will appear (see Figure 61):

FTP directory /geo/tiger/ at ftp2.census.gov

To view this FTP site in File Explorer: press Alt, click View, and then click **Open FTP Site in File Explorer**

[Up to higher level directory](#)

06/25/2019 12:00AM	449,182	Directory Contents ReadMe.pdf
07/24/2013 12:00AM	Directory	GENZ2010
07/24/2013 12:00AM	Directory	GENZ2012
07/02/2014 12:00AM	Directory	GENZ2013
07/20/2017 12:00AM	Directory	GENZ2014
07/20/2017 12:00AM	Directory	GENZ2015
07/20/2017 12:00AM	Directory	GENZ2016
04/04/2018 12:00AM	Directory	GENZ2017
05/02/2019 12:00AM	Directory	GENZ2018
06/20/2013 12:00AM	Directory	PREVGENZ
03/23/2015 12:00AM	Directory	TGRGDB13
03/31/2015 12:00AM	Directory	TGRGDB14
08/20/2015 12:00AM	Directory	TGRGDB15
09/20/2016 12:00AM	Directory	TGRGDB16
09/14/2017 12:00AM	Directory	TGRGDB17
08/05/2019 01:46PM	Directory	TGRGDB18
08/09/2019 10:21AM	Directory	TGRGDB19
12/19/2011 12:00AM	Directory	TIGER1992
02/13/2012 12:00AM	Directory	TIGER1999
05/05/2015 12:00AM	Directory	TIGER2002
03/30/2017 12:00AM	Directory	TIGER2003
03/26/2008 12:00AM	Directory	TIGER2007FE
11/26/2008 12:00AM	Directory	TIGER2008
09/23/2009 12:00AM	Directory	TIGER2009
06/13/2012 12:00AM	Directory	TIGER2010
06/08/2011 12:00AM	Directory	TIGER2010BLKPOPHU
05/14/2015 12:00AM	Directory	TIGER2010DP1
12/12/2011 12:00AM	Directory	TIGER2011
01/30/2013 12:00AM	Directory	TIGER2012
06/07/2013 12:00AM	Directory	TIGER2012 ADDLOCATOR
08/21/2013 12:00AM	Directory	TIGER2013
08/19/2014 12:00AM	Directory	TIGER2014
09/28/2017 12:00AM	Directory	TIGER2015
12/06/2016 12:00AM	Directory	TIGER2016
09/28/2017 12:00AM	Directory	TIGER2017
09/18/2018 12:00AM	Directory	TIGER2018
02/21/2019 12:00AM	Directory	TIGER2018PLtest
08/28/2019 12:21PM	Directory	TIGER2019
04/04/2019 12:00AM	Directory	TIGER DP
01/15/2013 12:00AM	Directory	TIGERrd13
01/15/2013 12:00AM	Directory	TIGERrd13 st
11/04/2013 12:00AM	Directory	rd 2ktiger
03/14/2003 12:00AM	Directory	tgrcd108
05/05/2015 12:00AM	Directory	tiger2005se
02/24/2009 12:00AM	Directory	tiger2006se
11/04/2013 12:00AM	Directory	tiger2k
11/04/2013 12:00AM	Directory	tigerua

Figure 61: FTP Client, Directory results for geo/tiger

The Directory_Contents_ReadMe file (.pdf) gives a summary of what each of these directories contain.

Select the directory you wish to see (e.g., TIGER2019) and the following screen will appear (see Figures 62 and 63).

FTP directory /geo/tiger/TIGER2019/ at ftp2.census.gov

To view this FTP site in File Explorer: press Alt, click View, and then click Open FTP Site in File Explorer

[Up to higher level directory](#)

08/09/2019 12:00AM	Directory	ADDR
08/09/2019 12:00AM	Directory	ADDRFEAT
08/09/2019 12:00AM	Directory	ADDRFN
08/09/2019 12:00AM	Directory	ATANNH
08/09/2019 12:00AM	Directory	AITSN
08/09/2019 12:00AM	Directory	ANRC
08/09/2019 12:00AM	Directory	AREALM
08/09/2019 12:00AM	Directory	AREAWATER
08/09/2019 12:00AM	Directory	BG
08/09/2019 12:00AM	Directory	CBSA
08/09/2019 12:00AM	Directory	CD
08/09/2019 12:00AM	Directory	CNECTA
08/09/2019 12:00AM	Directory	COASTLINE
08/09/2019 12:00AM	Directory	CONCITY
08/09/2019 12:00AM	Directory	COUNTY
08/09/2019 12:00AM	Directory	COUSUB
08/09/2019 12:00AM	Directory	CSA
08/09/2019 12:00AM	Directory	EDGES
08/09/2019 12:00AM	Directory	ELSD
08/09/2019 12:00AM	Directory	ESTATE
08/09/2019 12:00AM	Directory	FACES
08/09/2019 12:00AM	Directory	FACESAH
08/09/2019 12:00AM	Directory	FACESAL
08/09/2019 12:00AM	Directory	FACESMIL
08/09/2019 12:00AM	Directory	FEATNAMES
08/09/2019 12:00AM	Directory	LINEARWATER
08/09/2019 12:00AM	Directory	METDIV
08/09/2019 12:00AM	Directory	MIL
08/09/2019 12:00AM	Directory	NECTA
08/09/2019 12:00AM	Directory	NECTADIV
08/09/2019 12:00AM	Directory	PLACE
08/09/2019 12:00AM	Directory	POINTLM
08/09/2019 12:00AM	Directory	PRIMARYROADS

Figure 62: Directory of Geo/tiger/TIGER2019, Part 1

08/09/2019 12:00AM	Directory	PRISECROADS
08/09/2019 12:00AM	Directory	PUMA
08/09/2019 12:00AM	Directory	RAILS
08/09/2019 12:00AM	Directory	ROADS
08/09/2019 12:00AM	Directory	SCSD
08/09/2019 12:00AM	Directory	SLDL
08/09/2019 12:00AM	Directory	SLDU
08/09/2019 12:00AM	Directory	STATE
08/09/2019 12:00AM	Directory	SUBMCD
08/09/2019 12:00AM	Directory	TABBLOCK
08/09/2019 12:00AM	Directory	TBG
08/09/2019 12:00AM	Directory	TRACT
08/09/2019 12:00AM	Directory	TTRACT
08/09/2019 12:00AM	Directory	UAC
08/09/2019 12:00AM	Directory	UNSD
08/09/2019 12:00AM	Directory	ZCTA5

Figure 63: Directory of Geo/tiger/TIGER2019, Part 2

Select the map information you want to see (e.g. COUNTY) and the following screen will appear (see Figure 64).

FTP directory /geo/tiger/TIGER2019/COUNTY/ at ftp2.census.gov

To view this FTP site in File Explorer: press Alt, click **View**, and then click **Open FTP Site in File Explorer**.

Server: ftp2.census.gov

Personal Identifiable Information (PII) shall not be placed on the FTP server without prior special arrangement and in conjunction with ITSO.

NOTE: The data available for anonymous FTP download on this FTP server are also available over the Web:
<http://www2.census.gov>

[Up to higher level directory](#)

08/09/2019 12:08AM 79,237,324 [t1 2019 us county.zip](#)

Figure 64: Directory of Geo/tiger/TIGER2019/COUNTY

6.7 Data.gov

The TIGER/Line Shapefiles and Relationship files are also available through the following website

<<https://www.data.gov/>>

<<https://catalog.data.gov/organization/census-gov>>

Then the following screen appears (see Figure 65).

Refer to [Appendix S](#) for the shapefile naming conventions.

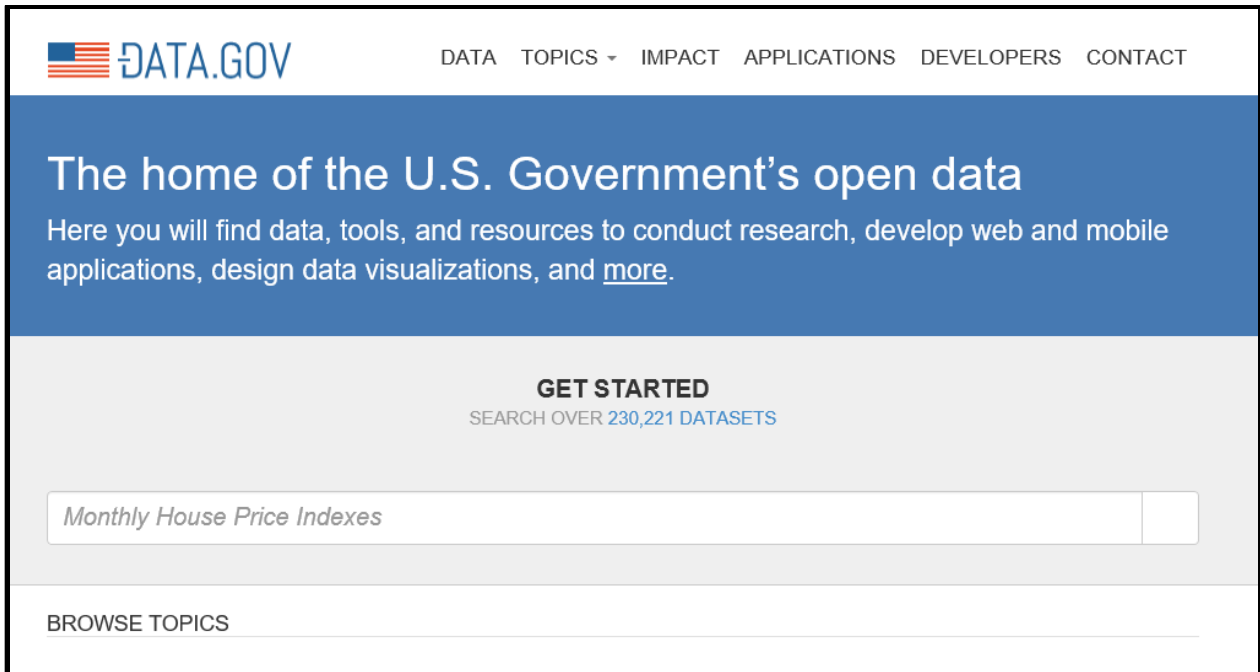

Figure 65: Data.gov

To narrow your search, you can select the DATA tab (to search by data sets) on the top of the screen (See Figure 66 black box)

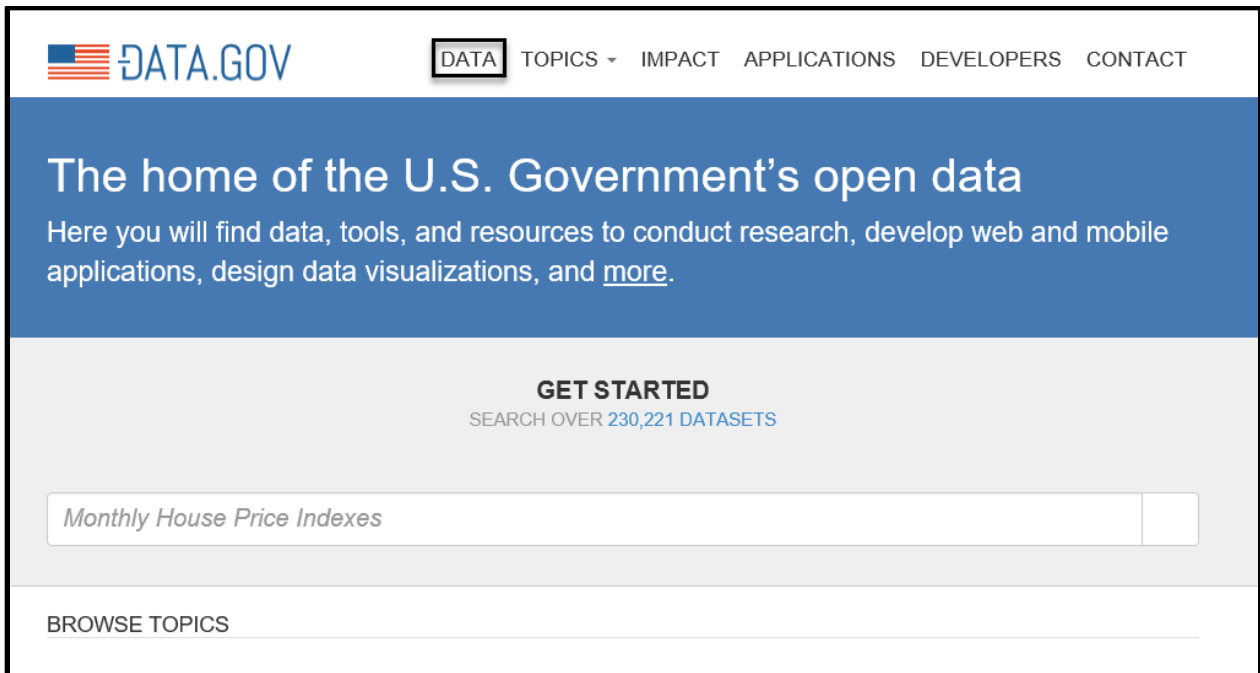

Figure 66: Data.gov Data tab selection

Then the following screen appears (see Figure 67):

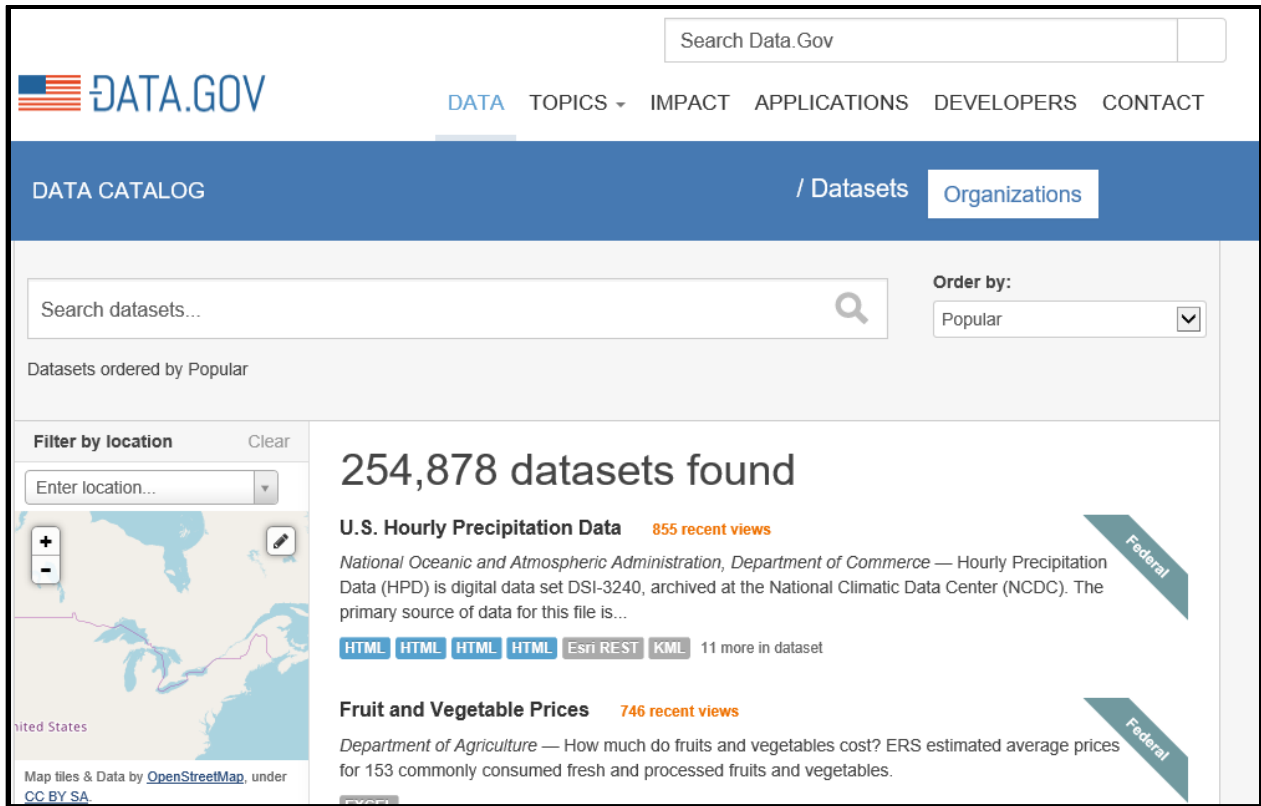

Figure 67: Data.gov Data tab results

To narrow the search results down to only the US Census Bureau data sets.

Click Organizations box (shown in figure 68 with black box)

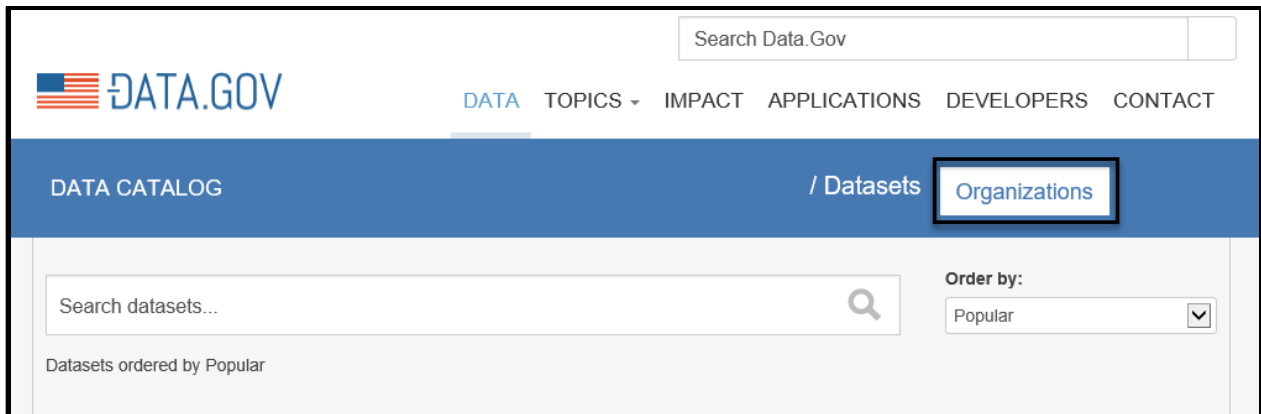

Figure 68: Data.gov Organization selection

Then the following screen appears (see figure 69):

Search Data.Gov

DATA.GOV DATA TOPICS ▾ IMPACT APPLICATIONS DEVELOPERS CONTACT

DATA CATALOG / Datasets **Organizations**

/ Organizations

What are organizations?

Organizations are entities that publish and manage datasets (for example, the U.S. Geological Survey or NASA). Organizations own the datasets that are published under them. Within organizations, administrators can authorize members and assign them roles, giving them the right to publish datasets from that particular organization.

Search organizations...

Order by: Name Ascending ▾

196 organizations found



Arctic Landscape Conservation Cooperative

The Arctic Landscape Conservation Cooperative (ALCC) supports conservation in...

3 Datasets



Allegheny County / City of Pittsburgh / Western PA Regional Data Center

Allegheny County (Pennsylvania) and the City of Pittsburgh both publish their...

250 Datasets



American Battle Monuments Commission

The American Battle Monuments Commission, established by Congress in 1923, is...

0 Datasets



State of Arkansas

Figure 69: Data.gov Organization menu

Either put "Census Bureau" in the Search organizations box or scroll down to the US Census Bureau box and click. Then the following screen appears (see figure 70).

The screenshot shows the Data.gov website interface for the US Census Bureau. At the top, there is a navigation bar with links for DATA, TOPICS, IMPACT, APPLICATIONS, DEVELOPERS, and CONTACT. Below this is a blue header with 'DATA CATALOG' and a breadcrumb trail '/ Datasets Organizations'. The main content area is titled '/ US Census Bureau, Department of ...' and features a sidebar on the left with the 'United States Census Bureau' logo and a description of their mission. The main content area has a search bar labeled 'Search datasets...' and an 'Order by:' dropdown menu set to 'Relevance'. A notification states '1,527 datasets found'. Two dataset listings are visible: 'TIGER/Line Shapefile, 2017, nation, U.S., Current Metropolitan Statistical Area/Micropolitan Statistical Area (CBSA) National' with 156 recent views, and 'TIGER/Line Shapefile, 2015, nation, U.S., Rails National Shapefile' with 75 recent views. Each listing includes a brief description and a row of format options: ZIP, HTML, WMS, and Esri REST.

Figure 70: Data.gov Census Bureau menu

Search for the shapefile in the search datasets box.

Some Shapefiles are available in multiple output formats.

Select the format of the shapefile to view.

7. Useful Links

7.1 User Notes

The Census Bureau posts user notes to share information concerning errors in or corrections to the TIGER/Line Shapefiles. Examples of such errors are duplicate records or missing attribute information.

User notes are located on the main TIGER/Line Shapefile webpage:

<<https://www.census.gov/geo/maps-data/data/tiger-line.html>>

User notes are unique to each release of TIGER/Line Shapefiles. Click on the appropriate year's tab to find that year's user notes.

7.2 Help Documents

Additional information about each geographic entity, available as a TIGER/Line Shapefile, is in several formats. For basic definitions, visit:

<<https://www.census.gov/programs-surveys/geography/library/reference.html>>

This site provides definitions of geographic terms and concepts for geographic entities found in the TIGER/Line Shapefiles and other Census Bureau data products.

For more in depth information, blog posts and brochures offer a more detailed look at some of the geographic entities available in shapefile format. Blog posts are located here:

<https://www.census.gov/about/contact-us/social_media.html>

For specific information about each state's geographic entities, history, rankings, and more, you can read the Guide to State and Local Census Geography pages here

<<https://www.census.gov/geographies/reference-files/2010/geo/state-local-geo-guides-2010.html>>

Definitions for several of the codes found in the attributes of the TIGER/Line Shapefiles are located in the following links:

Legal/Statistical Area Description (LSAD) Codes

<<https://www.census.gov/library/reference/code-lists/legal-status-codes.html>>

Class (CLASSFP) Codes

<<https://www.census.gov/library/reference/code-lists/class-codes.html>>

Functional Status (FUNCSTAT) Codes

<<https://www.census.gov/library/reference/code-lists/functional-status-codes.html>>

Route Type (RTTYP) Codes

<<https://www.census.gov/library/reference/code-lists/route-type-codes.html>>

7.3 Additional TIGER Products for use in a GIS

7.3.1 TIGER Geodatabases

TIGER Geodatabases are spatial extracts from the Census Bureau's MTDB for use with Esri's ArcGIS. The geodatabases contain both national and state coverage for boundaries and features. These files provide access to large amounts of geographic data with one download; however, the files are large. Technical documentation for the TIGER Geodatabases is available. These files are available here: <https://www.census.gov/geographies/mapping-files/time-series/geo/tiger-geodatabase-file.html>

7.3.2 TIGER/Line Shapefiles and Geodatabases with Demographic Data

A limited set of TIGER/Line Shapefiles and TIGER Geodatabases are available with demographic data, including the 2010 Census and the American Community Survey. These files attempt to make GIS analysis and thematic mapmaking easier by providing the geography and demographic data in one download. Each file also contains a metadata file to provide additional information about the demographic data included. These files are available here:

<https://www.census.gov/geographies/mapping-files/time-series/geo/tiger-data.html>

7.3.3 Cartographic Boundary Files

The Cartographic Boundary files are simplified representations of selected geographic areas from the Census Bureau's MTDB. The Census Bureau designs these boundary files specifically for small-scale, thematic mapping to show a simplified version of the U.S. outline. Cartographic boundary files are available in shapefile format for the 2010 Census, Census 2000, and selected geographies for other years. In addition, Cartographic Boundary files are available in shapefile and Keyhole Markup Language (KML) format (started in 2013 and updates are available annually one year after their corresponding TIGER/Line Shapefile release). The cartographic boundary files have less attribute information than the TIGER/Line Shapefiles and are not available for all the same geographic entities as the TIGER/Line Shapefiles. Cartographic boundary files are available here:

<https://www.census.gov/programs-surveys/geography/technical-documentation/naming-convention/cartographic-boundary-file.html>

Appendix A. Pseudo-School Districts

2020 School District Review Program Pseudo-School Districts (stored as Unified School Districts)

Column headers:

STATEFP20 2020 Census state FIPS code
 SDLEA20 2020 Census unified school district local education agency code
 NAME20 2020 Census unified school district name

STATEFP20	SDLEA20	NAME20
34	34001	Joint Base McGuire-Dix-Lakehurst

Figure 71: Appendix A: Unified School Districts

2020 School District Review Program Pseudo-School Districts (stored as Elementary School Districts)

Column headers:

STATEFP20 2020 Census state FIPS code
 SDLEA20 2020 Census elementary school district local education agency code
 NAME20 2020 Census elementary school district name

STATEFP20	SDLEA20	NAME20
17	99002	Bluford Unit School District 318 (KG-8) in Mount Vernon
17	99003	Woodlawn Unit District 209 (KG-8) in Mount Vernon
17	99007	Woodlawn Unit District 209 (KG-8) in Nashville

Figure 72: Appendix A: Elementary School Districts

2020 School District Review Program Pseudo-School Districts (stored as Secondary School Districts)

Column headers:

STATEFP20 2020 ACS state FIPS code
 SDLEA20 2020 ACS secondary school district local education agency code
 NAME20 2020 ACS secondary school district name

STATEFP20	SDLEA20	NAME20
06	06001	Yosemite Unified School District (9-12)
06	06003	Twin Rivers Unified School District (9-12)
06	06004	Twin Rivers Unified School District (7-12)
06	06005	Scott Valley Unified School District (9-12)
06	06006	Trinity Alps Unified School District (9-12)
06	06013	Turlock Unified School District (9-12)
06	06015	Santa Cruz City High School District (9-12)
06	06016	Dinuba Unified School District (9-12)
06	06018	Washington Unified School District (9-12)
06	06019	Santa Barbara Unified School District (7-12)
06	06020	Lammersville Joint Unified School District (9-12)
06	06021	Bishop Unified School District (9-12)
06	06022	Santa Paula Unified School District (9-12)
06	06025	Hamilton Unified School District (9-12)
06	06026	Woodlake Unified School District (9-12)
06	06028	Exeter Unified School District (9-12)
06	06031	Tracy Unified School District (9-12)
06	06034	Perris Union High School District (9-12)
06	06037	Alhambra Unified School District (9-12)
06	06038	Healdsburg Unified School District (7-12)
06	06053	Gonzales Unified School District (9-12)
06	06107	Porterville Unified School District (9-12)
06	99001	Gridley Unified School District (9-12)
06	99002	Caruthers Unified School District (9-12)
06	99003	Riverdale Joint Unified School District (9-12)
06	99004	Sierra Unified School District (9-12)
06	99005	Orland Joint Unified School District (9-12)
06	99006	Eureka City Unified School District (7-12)
06	99007	Eureka City Unified School District (9-12)
06	99008	Upper Lake Unified School District (9-12)
06	99009	Coast Unified School District (9-12)
06	99010	Paso Robles Joint Unified School District (9-12)
06	99011	Santa Cruz City High School District (6-12)
06	99012	Hughson Unified School District (9-12)
06	99013	Oakdale Joint Unified School District (9-12)
06	99014	Nevada Joint Union High School District (9-12)
13	13053	Chattahoochee County for Fort Benning
13	13215	Muscogee County for Fort Benning
17	17901	Flanagan-Cornell District 74 in Cornell
17	17902	Flanagan-Cornell District 74 in Pontiac
17	17903	Flanagan-Cornell District 74 in Rooks Creek
17	99001	Bluford Unit School District 318 (9-12) in Farrington
17	99004	Bluford Unit School District 318 (9-12) in Opdyke-Belle Rive
17	99005	Woodlawn Unit District 209 (9-12) in Grand Prairie

17	99006	Woodlawn Unit District 209 (9-12) in Rome
17	99008	Woodlawn Unit District 209 (9-12) in Ashley
21	21001	Laurel County School District for East Bernstadt ISD
21	21002	Pulaski County School District for Science Hill ISD
21	21003	Elizabethtown Independent School District for West Point ISD
21	21004	Jefferson County School District in Anchorage ISD
21	21005	Campbell County School District in Southgate ISD
25	22222	Mohawk Trail Regional School District in Hawley and Charlemont towns
25	25002	North Adams School District in Clarksburg (9-12)
25	25003	Gill-Montague School District in Erving (7-12)
25	25005	Swampscott School District in Nahant (7-12)
25	25006	Pittsfield School District in Richmond (9-12)
25	25007	Mohawk Trail School District in Rowe (7-12)
25	25008	Hoosac Valley School District in Savoy (7-12)
25	25009	North Adams School District in Florida (9-12)
25	25010	Fairhaven/New Bedford School Districts in Acushnet (9-12)
25	25012	Nauset/Provincetown School Districts in Turo (7-12)
25	25013	Mount Greylock/New Lebanon (NY) School Districts in Hancock (7-12)
25	25014	North Adams School District in Monroe (9-12)
25	25015	Lee/Berkshire Hills in Farmington River Regional (7-12)
27	27001	Park Rapids Public School District in Pine Point (9-12)
40	40001	Secondary Coverage Area in White Oak Public Schools (9-12)
40	99001	Frederick Public Schools in Davidson (9-12)
45	45013	Beaufort County School District within Beaufort Marine Corps Air Station
45	45079	Richland County School District 2 within Fort Jackson
47	47001	Anderson County School District in Clinton
47	47002	Arlington Community Schools in Lakeland (9-12)
47	47029	Cocke County School District in Newport
47	47031	Coffee County School District in Manchester
47	47033	Crockett County School District in Alamo
47	47034	Crockett County School District in Bells
47	47073	Hawkins County School District in Rogersville
47	47077	Henderson County School District in Lexington
47	47079	Henry County School District in Paris
47	47107	McMinn County School District in Athens
47	47108	McMinn County School District in Etowah
47	47123	Monroe County School District in Sweetwater
47	47143	Rhea County School District in Dayton
47	47149	Rutherford County School District in Murfreesboro
47	47187	Williamson County School District in Franklin
47	47189	Wilson County School District in Lebanon
48	48285	Hallettsville Independent School District (9-12) in Vysehrad

Figure 73: Appendix A: Secondary School Districts

Appendix B. Feature Name Directions

Direction Code	Expanded Full Text	Directional Abbreviation	Spanish	Translation
11	North	N	-	-
12	South	S	-	-
13	East	E	-	-
14	West	W	-	-
15	Northeast	NE	-	-
16	Northwest	NW	-	-
17	Southeast	SE	-	-
18	Southwest	SW	-	-
19	Norte	N	Y	North
20	Sur	S	Y	South
21	Este	E	Y	East
22	Oeste	O	Y	West
23	Noreste	NE	Y	Northeast
24	Noroeste	NO	Y	Northwest
25	Sudeste	SE	Y	Southeast
26	Sudoeste	SO	Y	Southwest

Figure 74: Appendix B: Feature Name Directions

Appendix C. Feature Name Qualifiers

Qualifier Code	Expanded Full Text	Display Name Abbreviation	Prefix Qualifier	Suffix Qualifier
11	Access	Acc	N	Y
12	Alternate	Alt	Y	Y
13	Business	Bus	Y	Y
14	Bypass	Byp	Y	Y
15	Connector	Con	N	Y
16	Extended	Exd	Y	Y
17	Extension	Exn	N	Y
18	Historic	Hst	Y	N
19	Loop	Lp	Y	Y
20	Old	Old	Y	N
21	Private	Pvt	Y	Y
22	Public	Pub	Y	Y
23	Scenic	Scn	N	Y
24	Spur	Spr	Y	Y
25	Ramp	Rmp	N	Y
26	Underpass	Unp	N	Y
27	Overpass	Ovp	N	Y

Figure 75: Appendix C: Feature Name Qualifiers

Appendix D. Feature Name Types

Type Code	Expanded Full Text	Display Name abbreviation	Spanish	Spanish Translation	Prefix Type	Suffix Type
103	Academy	Acdmy	No	N/A	Y	Y
104	Acueducto	Acueducto	Yes	Aqueduct	Y	N
105	Aeropuerto	Aero	Yes	Airport	Y	N
106	Air Force Base	AFB	No	N/A	N	Y
107	Airfield	Airfield	No	N/A	N	Y
108	Airpark	Airpark	No	N/A	N	Y
109	Airport	Arprt	No	N/A	N	Y
110	Airstrip	Airstrip	No	N/A	N	Y
112	Alley	Aly	No	N/A	N	Y
115	Apartment Building	Apt Bldg	No	N/A	N	Y
116	Apartment Complex	Apt Complex	No	N/A	N	Y
117	Apartments	Apts	No	N/A	N	Y
118	Aqueduct	Aqueduct	No	N/A	N	Y
119	Arcade	Arc	No	N/A	Y	Y
121	Arroyo	Arroyo	Yes	Stream	Y	N
122	Assisted Living Center	Asstd Liv Ctr	No	N/A	N	Y
694	Assisted Living Facility	Asstd Liv Fac	No	N/A	N	Y
123	Autopista	Autopista	Yes	Expressway or Freeway	Y	N
124	Avenida	Ave	Yes	Avenue	Y	N
125	Avenue	Ave	No	N/A	Y	Y
126	Bahia	Bahía	Yes	Bay	Y	N
127	Bank	Bk	No	N/A	Y	Y
704	Base	Base	No	N/A	N	Y
128	Basin	Basin	No	N/A	N	Y
129	Bay	Bay	No	N/A	Y	Y
130	Bayou	Byu	No	N/A	Y	Y
131	Beach	Bch	No	N/A	N	Y
132	Bed and Breakfast	B and B	No	N/A	N	Y
136	Beltway	Beltway	No	N/A	N	Y
137	Bend	Bnd	No	N/A	N	Y
138	Bluff	Blf	No	N/A	N	Y
139	Boarding House	Brdng Hse	No	N/A	N	Y
140	Bog	Bog	No	N/A	N	Y
141	Bosque	Bosque	Yes	Forest	Y	N
142	Boulevard	Bldv	No	N/A	Y	Y
143	Boundary	Boundary	No	N/A	N	Y
146	Branch	Br	No	N/A	Y	Y

Type Code	Expanded Full Text	Display Name abbreviation	Spanish	Spanish Translation	Prefix Type	Suffix Type
147	Bridge	Brg	No	N/A	N	Y
148	Brook	Brk	No	N/A	N	Y
149	Building	Bldg	No	N/A	Y	Y
150	Bulevar	Bulevar	Yes	Boulevard	Y	N
151	Bureau of Indian Affairs Highway	BIA Hwy	No	N/A	Y	N
152	Bureau of Indian Affairs Road	BIA Rd	No	N/A	Y	N
153	Bureau of Indian Affairs Route	BIA Rte	No	N/A	Y	N
154	Bureau of Land Management Road	BLM Rd	No	N/A	Y	N
696	Bypass	Byp	No	N/A	Y	Y
156	Calle	Cll	Yes	Street	Y	N
157	Calleja	Calleja	Yes	Narrow Street	Y	N
158	Callejón	Callejón	Yes	Alley	Y	N
159	Caminito	Cmt	Yes	Little Road	Y	N
160	Camino	Cam	Yes	Road or Way	Y	N
161	Camp	Cp	No	N/A	Y	Y
163	Campground	Cmpgrnd	No	N/A	N	Y
164	Campus	Cmps	No	N/A	N	Y
165	Canal	Cnl	No	N/A	Y	Y
172	Cano	Caño	Yes	Drain or Sewer	Y	N
166	Cantera	Cantera	Yes	Quarry or Gravel Pit	Y	N
167	Canyon	Cyn	No	N/A	Y	Y
168	Capilla	Capilla	Yes	Chapel	Y	N
169	Carretera	Carr	Yes	Road	Y	N
170	Causeway	Cswy	No	N/A	N	Y
171	Cayo	Cayo	Yes	Key	Y	N
173	Cementerio	Cem	Yes	Cemetery	Y	N
174	Cemetery	Cmtry	No	N/A	N	Y
175	Center	Ctr	No	N/A	Y	Y
176	Centro	Centro	Yes	Center	Y	N
177	Cerrada	Cer	Yes	Closed	Y	N
178	Chamber of Commerce	Cham of Com	No	N/A	N	Y
179	Channel	Chnnl	No	N/A	N	Y
180	Chapel	Cpl	No	N/A	Y	Y
181	Childrens Home	Childrens Home	No	N/A	N	Y
182	Church	Church	No	N/A	Y	Y
183	Circle	Cir	No	N/A	N	Y
234	Círculo	Cír	Yes	Circle	Y	N
184	City Hall	City Hall	No	N/A	N	Y

Type Code	Expanded Full Text	Display Name abbreviation	Spanish	Spanish Translation	Prefix Type	Suffix Type
185	City Park	City Park	No	N/A	N	Y
186	Cliff	Clf	No	N/A	N	Y
187	Club	Clb	No	N/A	Y	Y
188	Colegio	Colegio	Yes	School	Y	N
189	College	Colg	No	N/A	Y	Y
190	Common	Cmn	No	N/A	N	Y
191	Commons	Cmns	No	N/A	Y	Y
192	Community Center	Community Ctr	No	N/A	N	Y
193	Community College	Community Colg	No	N/A	Y	Y
194	Community Park	Community Park	No	N/A	Y	Y
195	Complex	Complex	No	N/A	N	Y
197	Condominios	Condios	Yes	Condominiums	Y	N
198	Condominium	Condo	No	N/A	Y	Y
199	Condominiums	Condos	No	N/A	N	Y
201	Convent	Cnvnt	No	N/A	Y	Y
202	Convention Center	Convention Ctr	No	N/A	Y	Y
203	Corners	Cors	No	N/A	N	Y
204	Correctional Facility	Corr Facilty	No	N/A	N	Y
205	Correctional Institute	Corr Inst	No	N/A	N	Y
207	Corte	Corte	Yes	Court	Y	N
679	Cottage	Cottage	No	N/A	N	Y
208	Coulee	Coulee	No	N/A	N	Y
209	Country Club	Country Club	No	N/A	Y	Y
210	County Highway	Co Hwy	No	N/A	Y	N
211	County Home	Co Home	No	N/A	Y	Y
212	County Lane	Co Ln	No	N/A	Y	N
213	County Park	Co Park	No	N/A	N	Y
214	County Road	Co Rd	No	N/A	Y	N
215	County Route	Co Rte	No	N/A	Y	N
216	County State Aid Highway	Co St Aid Hwy	No	N/A	Y	N
217	County Trunk Highway	Co Trunk Hwy	No	N/A	Y	N
218	County Trunk Road	Co Trunk Rd	No	N/A	Y	N
219	Course	Crs	No	N/A	N	Y
220	Court	Ct	No	N/A	Y	Y
221	Courthouse	Courthouse	No	N/A	N	Y
222	Courts	Cts	No	N/A	N	Y
223	Cove	Cv	No	N/A	N	Y
225	Creek	Crk	No	N/A	N	Y
226	Crescent	Cres	No	N/A	N	Y

Type Code	Expanded Full Text	Display Name abbreviation	Spanish	Spanish Translation	Prefix Type	Suffix Type
227	Crest	Crst	No	N/A	N	Y
228	Crossing	Xing	No	N/A	N	Y
229	Crossroads	Xroad	No	N/A	Y	Y
233	Cutoff	Cutoff	No	N/A	N	Y
235	Dam	Dm	No	N/A	N	Y
236	Delta Road	Delta Rd	No	N/A	Y	N
237	Department	Dept	No	N/A	Y	Y
238	Depot	Dep	No	N/A	N	Y
239	Detention Center	Detention Ctr	No	N/A	N	Y
240	District of Columbia Highway	DC Hwy	No	N/A	Y	N
241	Ditch	Ditch	No	N/A	Y	Y
242	Divide	Dv	No	N/A	N	Y
243	Dock	Dock	No	N/A	N	Y
244	Dormitory	Dormitory	No	N/A	N	Y
245	Drain	Drn	No	N/A	N	Y
246	Draw	Draw	No	N/A	N	Y
247	Drive	Dr	No	N/A	N	Y
248	Driveway	Driveway	No	N/A	Y	Y
249	Dump	Dump	No	N/A	N	Y
251	Edificio	Edif	Yes	Building	Y	N
252	Elementary School	Elem School	No	N/A	N	Y
253	Ensenada	Ensenada	Yes	Cove	Y	N
254	Entrada	Ent	Yes	Entrance	Y	N
256	Escuela	Escuela	Yes	School	Y	N
680	Esplanade	Esplanade	Yes	Esplanade	Y	Y
257	Estates	Ests	No	N/A	N	Y
260	Estuary	Estuary	No	N/A	N	Y
261	Expreso	Expreso	Yes	Expressway	Y	N
262	Expressway	Expy	No	N/A	Y	Y
263	Extension	Ext	No	N/A	Y	Y
264	Facility	Facilty	No	N/A	N	Y
265	Fairgrounds	Fairgrounds	No	N/A	N	Y
266	Falls	Fls	No	N/A	Y	Y
267	Farm	Frm	No	N/A	N	Y
268	Farm Road	Farm Rd	No	N/A	Y	N
269	Farm-to-Market Road	FM	No	N/A	Y	N
275	Fence Line	Fence Line	No	N/A	N	Y
276	Ferry Crossing	Ferry Crossing	No	N/A	Y	Y
277	Field	Fld	No	N/A	N	Y

Type Code	Expanded Full Text	Display Name abbreviation	Spanish	Spanish Translation	Prefix Type	Suffix Type
278	Fire Control Road	Fire Cntrl Rd	No	N/A	Y	N
279	Fire Department	Fire Dept	No	N/A	N	Y
280	Fire District Road	Fire Dist Rd	No	N/A	Y	N
281	Fire Lane	Fire Ln	No	N/A	Y	N
282	Fire Road	Fire Rd	No	N/A	Y	N
283	Fire Route	Fire Rte	No	N/A	Y	N
284	Fire Station	Fire Sta	No	N/A	Y	Y
285	Fire Trail	Fire Trl	No	N/A	Y	N
286	Flowage	Flowage	No	N/A	N	Y
287	Flume	Flume	No	N/A	N	Y
288	Forest	Frst	No	N/A	N	Y
289	Forest Highway	Forest Hwy	No	N/A	Y	Y
290	Forest Road	Forest Rd	No	N/A	Y	N
291	Forest Route	Forest Rte	No	N/A	Y	N
292	Forest Service Road	FS Rd	No	N/A	Y	N
293	Fork	Frk	No	N/A	N	Y
294	Fort	Ft	No	N/A	Y	N
295	Four-Wheel Drive Trail	4WD Trl	No	N/A	Y	Y
296	Fraternity	Frtrnty	No	N/A	N	Y
297	Freeway	Fwy	No	N/A	N	Y
298	Garage	Grge	No	N/A	N	Y
299	Gardens	Gdns	No	N/A	N	Y
303	Glacier	Glacier	No	N/A	N	Y
304	Glen	Gln	No	N/A	N	Y
305	Golf Club	Golf Club	No	N/A	Y	Y
306	Golf Course	Golf Course	No	N/A	Y	Y
307	Grade	Grade	No	N/A	N	Y
309	Green	Grn	No	N/A	N	Y
310	Group Home	Group Home	No	N/A	N	Y
311	Gulch	Gulch	No	N/A	N	Y
312	Gulf	Gulf	No	N/A	Y	Y
313	Gully	Gully	No	N/A	N	Y
314	Halfway House	Halfway House	No	N/A	N	Y
315	Hall	Hall	No	N/A	N	Y
316	Harbor	Hbr	No	N/A	N	Y
317	Heights	Hts	No	N/A	N	Y
321	High School	High School	No	N/A	N	Y
322	Highway	Hwy	No	N/A	Y	Y
323	Hill	Hl	No	N/A	N	Y

Type Code	Expanded Full Text	Display Name abbreviation	Spanish	Spanish Translation	Prefix Type	Suffix Type
324	Hollow	Holw	No	N/A	N	Y
325	Home	Home	No	N/A	Y	Y
326	Hospital	Hosp	No	N/A	Y	Y
327	Hostel	Hostel	No	N/A	N	Y
328	Hotel	Hotel	No	N/A	Y	Y
329	House	Hse	No	N/A	Y	Y
330	Housing	Hsng	No	N/A	Y	Y
332	Iglesia	Iglesia	Yes	Church	Y	N
333	Indian Route	Indian Rte	No	N/A	Y	N
334	Indian Service Route	Indian Svc Rte	No	N/A	Y	N
336	Industrial Park	Indl Park	No	N/A	N	Y
337	Inlet	Inlt	No	N/A	N	Y
338	Inn	Inn	No	N/A	Y	Y
339	Institute	Inst	No	N/A	Y	Y
340	Institution	Instn	No	N/A	N	Y
341	Instituto	Instituto	Yes	Institute	Y	N
342	Intermediate School	Inter School	No	N/A	N	Y
344	Interstate Highway	I-	No	N/A	Y	N
345	Isla	Isla	Yes	Island	Y	N
346	Island	Is	No	N/A	N	Y
347	Islands	Iss	No	N/A	Y	Y
348	Isle	Isle	No	N/A	Y	Y
349	Jail	Jail	No	N/A	N	Y
351	Jeep Trail	Jeep Trl	No	N/A	Y	Y
352	Junction	Junction	No	N/A	N	Y
353	Junior High School	Jr HS	No	N/A	N	Y
356	Kill	Kill	No	N/A	Y	Y
357	Lago	Lago	Yes	Lake	Y	N
358	Lagoon	Lagoon	No	N/A	N	Y
360	Laguna	Laguna	Yes	Lagoon	Y	N
361	Lake	Lk	No	N/A	Y	Y
362	Lakes	Lks	No	N/A	N	Y
363	Landfill	Lndfll	No	N/A	N	Y
364	Landing	Lndg	No	N/A	N	Y
365	Landing Area	Landing Area	No	N/A	Y	Y
366	Landing Field	Landing Fld	No	N/A	Y	Y
367	Landing Strip	Landing Strp	No	N/A	Y	Y
368	Lane	Ln	No	N/A	Y	Y
369	Lateral	Lateral	No	N/A	Y	Y

Type Code	Expanded Full Text	Display Name abbreviation	Spanish	Spanish Translation	Prefix Type	Suffix Type
370	Levee	Levee	No	N/A	Y	Y
371	Library	Lbry	No	N/A	Y	Y
372	Lift	Lift	No	N/A	Y	Y
373	Lighthouse	Lighthouse	No	N/A	N	Y
374	Line	Line	No	N/A	Y	Y
376	Lodge	Ldg	No	N/A	N	Y
377	Logging Road	Logging Rd	No	N/A	Y	Y
378	Loop	Loop	No	N/A	Y	Y
379	Mall	Mall	No	N/A	Y	Y
380	Manor	Mnr	No	N/A	N	Y
381	Mar	Mar	Yes	Sea	Y	N
382	Marginal	Marginal	Yes	Service Road	Y	N
383	Marina	Mrna	No	N/A	N	Y
384	Marsh	Marsh	No	N/A	N	Y
385	Meadows	Mdws	No	N/A	N	Y
386	Medical Building	Medical Bldg	No	N/A	N	Y
387	Medical Center	Medical Ctr	No	N/A	Y	Y
388	Memorial	Meml	No	N/A	N	Y
389	Memorial Gardens	Memorial Gnds	No	N/A	N	Y
390	Memorial Park	Memorial Pk	No	N/A	N	Y
391	Mesa	Mesa	No	N/A	Y	Y
392	Middle School	Mid Schl	No	N/A	N	Y
393	Military Reservation	Mil Res	No	N/A	N	Y
394	Millpond	Millpond	No	N/A	N	Y
395	Mine	Mine	No	N/A	N	Y
396	Mission	Mssn	No	N/A	Y	Y
397	Mobile Home Community	Mobile Hm Cmty	No	N/A	Y	Y
398	Mobile Home Estates	Mobile Hm Est	No	N/A	Y	Y
399	Mobile Home Park	Mobile Hm Pk	No	N/A	Y	Y
400	Monastery	Monstry	No	N/A	Y	Y
401	Monument	Mnmt	No	N/A	N	Y
403	Mosque	Mosque	No	N/A	Y	Y
404	Motel	Mtl	No	N/A	Y	Y
405	Motor Lodge	Motor Lodge	No	N/A	N	Y
406	Motorway	Mtwy	No	N/A	N	Y
407	Mount	Mt	No	N/A	Y	Y
408	Mountain	Mtn	No	N/A	N	Y
411	Museum	Mus	No	N/A	Y	Y
412	National Battlefield	Natl Bfld	No	N/A	N	Y

Type Code	Expanded Full Text	Display Name abbreviation	Spanish	Spanish Translation	Prefix Type	Suffix Type
413	National Battlefield Park	Natl Bfld Pk	No	N/A	N	Y
414	National Battlefield Site	Natl Bfld Site	No	N/A	N	Y
415	National Conservation Area	Natl Cnsv Area	No	N/A	N	Y
416	National Forest	Natl Forest	No	N/A	N	Y
417	National Forest Development Road	Nat For Dev Rd	No	N/A	Y	N
419	National Grasslands	Natl Grsslnds	No	N/A	N	Y
420	National Historic Site	Natl Hist Site	No	N/A	N	Y
421	National Historical Park	Natl Hist Pk	No	N/A	N	Y
422	National Lakeshore	Natl Lkshr	No	N/A	N	Y
423	National Memorial	Natl Meml	No	N/A	N	Y
424	National Military Park	Natl Mil Pk	No	N/A	N	Y
425	National Monument	Natl Mnmt	No	N/A	N	Y
426	National Park	Natl Pk	No	N/A	N	Y
427	National Preserve	Natl Prsv	No	N/A	N	Y
428	National Recreation Area	Natl Rec Area	No	N/A	N	Y
429	National Recreational River	Natl Rec Riv	No	N/A	N	Y
430	National Reserve	Natl Resv	No	N/A	N	Y
431	National River	Natl Riv	No	N/A	N	Y
432	National Scenic Area	Natl Sc Area	No	N/A	N	Y
433	National Scenic River	Natl Sc Riv	No	N/A	N	Y
435	National Scenic Riverways	Natl Sc Rvrwys	No	N/A	N	Y
436	National Scenic Trail	Natl Sc Trl	No	N/A	N	Y
437	National Seashore	Natl Shr	No	N/A	N	Y
438	National Wildlife Refuge	Natl Wld Rfg	No	N/A	N	Y
439	Navajo Service Route	Navajo Svc Rte	No	N/A	Y	N
440	Naval Air Station	Naval Air Sta	No	N/A	N	Y
442	Nursing Home	Nurse Home	No	N/A	N	Y
444	Ocean	Ocean	No	N/A	N	Y
445	Oceano	Océano	Yes	Ocean	Y	N
446	Office	Ofc	No	N/A	Y	Y
447	Office Building	Office Bldg	No	N/A	N	Y
449	Office Park	Office Park	No	N/A	N	Y
698	Orchard	Orchard	No	N/A	N	Y
451	Orchards	Orchrds	No	N/A	N	Y
452	Orphanage	Orphanage	No	N/A	N	Y
453	Outlet	Outlet	No	N/A	N	Y
454	Oval	Oval	No	N/A	N	Y
455	Overpass	Opas	No	N/A	N	Y

Type Code	Expanded Full Text	Display Name abbreviation	Spanish	Spanish Translation	Prefix Type	Suffix Type
456	Parish Road	Parish Rd	No	N/A	Y	N
457	Park	Park	No	N/A	N	Y
458	Park and Ride	Park and Ride	No	N/A	N	Y
460	Parkway	Pkwy	No	N/A	N	Y
706	Parq	Parq	Yes	Park	Y	N
461	Parque	Parque	Yes	Park	Y	N
462	Pasaje	Pasaje	Yes	Passage	Y	N
463	Paseo	Pso	Yes	Path	Y	N
464	Pass	Pass	No	N/A	Y	Y
465	Passage	Psg	No	N/A	Y	Y
466	Path	Path	No	N/A	N	Y
682	Pavilion	Pavilion	No	N/A	N	Y
467	Peak	Peak	No	N/A	N	Y
705	Penitentiary	Penitentiary	No	N/A	N	Y
468	Pier	Pier	No	N/A	Y	Y
469	Pike	Pike	No	N/A	N	Y
470	Pipeline	Pipeline	No	N/A	N	Y
472	Place	Pl	No	N/A	N	Y
473	Placita	Pla	Yes	Little Plaza	Y	N
474	Plant	Plnt	No	N/A	N	Y
683	Plantation	Plantation	No	N/A	N	Y
475	Playa	Playa	Yes	Beach	Y	N
476	Playground	Playground	No	N/A	N	Y
477	Plaza	Plz	No	N/A	Y	Y
478	Point	Pt	No	N/A	Y	Y
479	Pointe	Pointe	No	N/A	N	Y
480	Police Department	Police Dept	No	N/A	Y	Y
481	Police Station	Police Station	No	N/A	Y	Y
482	Pond	Pond	No	N/A	Y	Y
483	Ponds	Ponds	No	N/A	N	Y
485	Port	Prt	No	N/A	Y	Y
486	Post Office	Post Office	No	N/A	N	Y
487	Power Line	Power Line	No	N/A	N	Y
691	Power Plant	Power Plant	No	N/A	N	Y
488	Prairie	Pr	No	N/A	N	Y
489	Preserve	Preserve	No	N/A	N	Y
491	Prison	Prison	No	N/A	N	Y
690	Prison Farm	Prison Farm	No	N/A	N	Y
685	Promenade	Promenade	No	N/A	N	Y

Type Code	Expanded Full Text	Display Name abbreviation	Spanish	Spanish Translation	Prefix Type	Suffix Type
492	Prong	Prong	No	N/A	N	Y
494	Puente	Puente	Yes	Bridge	Y	N
495	Quadrangle	Quadrangle	No	N/A	N	Y
496	Quarry	Quar	No	N/A	N	Y
686	Quarters	Quarters	No	N/A	N	Y
497	Quebrada	Qbda	Yes	Creek	Y	N
499	Race	Race	No	N/A	N	Y
501	Rail	Rail	No	N/A	N	Y
502	Rail Link	Rail Link	No	N/A	Y	Y
504	Railnet	Railnet	No	N/A	N	Y
505	Railroad	RR	No	N/A	N	Y
506	Railway	Rlwy	No	N/A	N	Y
507	Ramal	Ramal	Yes	Short Street	Y	N
508	Ramp	Ramp	No	N/A	N	Y
510	Ranch Road	Ranch Rd	No	N/A	Y	N
511	Ranch to Market Road	RM	No	N/A	Y	N
512	Rancho	Rch	Yes	Ranch or Farm	Y	N
513	Ravine	Ravine	No	N/A	N	Y
514	Recreation Area	Rec Area	No	N/A	N	Y
515	Reformatory	Reformatory	No	N/A	N	Y
516	Refuge	Refuge	No	N/A	N	Y
518	Regional Park	Regional Pk	No	N/A	N	Y
519	Reservation	Reservation	No	N/A	N	Y
520	Reservation Highway	Resvsn Hwy	No	N/A	Y	N
521	Reserve	Resv	No	N/A	N	Y
522	Reservoir	Reservoir	No	N/A	Y	Y
524	Residence Hall	Res Hall	No	N/A	N	Y
525	Residencial	Residencial	Yes	Public Housing Project	Y	N
526	Resort	Resrt	No	N/A	N	Y
688	Rest Home	Rest Home	No	N/A	N	Y
527	Retirement Home	Retirement Hme	No	N/A	N	Y
528	Retirement Village	Retirement Vlg	No	N/A	N	Y
529	Ridge	Rdg	No	N/A	N	Y
543	Rio	Río	Yes	River	Y	N
530	River	Riv	No	N/A	N	Y
531	Road	Rd	No	N/A	Y	Y
533	Roadway	Roadway	No	N/A	N	Y
535	Rock	Rock	No	N/A	Y	Y

Type Code	Expanded Full Text	Display Name abbreviation	Spanish	Spanish Translation	Prefix Type	Suffix Type
536	Rooming House	Rooming Hse	No	N/A	N	Y
537	Route	Rte	No	N/A	Y	Y
538	Row	Row	No	N/A	Y	Y
539	Rue	Rue	No	N/A	Y	Y
540	Run	Run	No	N/A	N	Y
541	Runway	Runway	No	N/A	Y	Y
542	Ruta	Ruta	Yes	Route	Y	N
498	RV Park	RV Park	No	N/A	N	Y
545	Sanitarium	Sanitarium	No	N/A	N	Y
546	School	Schl	No	N/A	Y	Y
549	Sea	Sea	No	N/A	Y	Y
550	Seashore	Seashore	No	N/A	N	Y
552	Sector	Sec	Yes	Sector	Y	N
553	Seminary	Smry	No	N/A	Y	Y
554	Sendero	Sendero	Yes	Foot Path	Y	N
555	Service Road	Svc Rd	No	N/A	Y	Y
556	Shelter	Shelter	No	N/A	N	Y
558	Shop	Shop	No	N/A	N	Y
699	Shopping Center	Shopping Ctr	No	N/A	N	Y
560	Shopping Mall	Shopping Mall	No	N/A	N	Y
700	Shopping Plaza	Shopping Plz	No	N/A	N	Y
703	Site	Site	No	N/A	N	Y
564	Skyway	Skwy	No	N/A	Y	Y
565	Slough	Slough	No	N/A	N	Y
566	Sonda	Sonda	Yes	Sound	Y	N
567	Sorority	Sorority	No	N/A	Y	Y
568	Sound	Snd	No	N/A	Y	N
569	Spa	Spa	No	N/A	Y	Y
570	Speedway	Speedway	No	N/A	Y	Y
571	Spring	Spg	No	N/A	N	Y
572	Spur	Spur	No	N/A	Y	Y
573	Square	Sq	No	N/A	Y	Y
575	State Beach	State Beach	No	N/A	N	Y
577	State Forest	State Forest	No	N/A	N	Y
578	State Forest Service Road	St FS Rd	No	N/A	Y	N
579	State Highway	State Hwy	No	N/A	Y	N
580	State Hospital	State Hospital	No	N/A	Y	Y
581	State Loop	State Loop	No	N/A	Y	N
582	State Park	State Park	No	N/A	N	Y

Type Code	Expanded Full Text	Display Name abbreviation	Spanish	Spanish Translation	Prefix Type	Suffix Type
584	State Prison	State Prison	No	N/A	N	Y
585	State Road	State Rd	No	N/A	Y	N
586	State Route	State Rte	No	N/A	Y	N
588	State Spur	State Spur	No	N/A	Y	N
589	State Trunk Highway	St Trunk Hwy	No	N/A	Y	N
591	Station	Sta	No	N/A	N	Y
592	Strait	Strait	No	N/A	Y	Y
593	Stravenue	Stra	No	N/A	N	Y
594	Stream	Strm	No	N/A	N	Y
595	Street	St	No	N/A	N	Y
596	Strip	Strip	No	N/A	Y	Y
599	Swamp	Swamp	No	N/A	N	Y
600	Synagogue	Synagogue	No	N/A	Y	Y
601	Tank	Tank	No	N/A	N	Y
603	Temple	Tmpl	No	N/A	Y	Y
604	Terminal	Trmnl	No	N/A	N	Y
605	Terrace	Ter	No	N/A	Y	Y
687	Thoroughfare	Thoroughfare	No	N/A	N	Y
607	Toll Booth	Toll Booth	No	N/A	Y	Y
701	Toll Road	Toll Rd	No	N/A	N	Y
610	Tollway	Tollway	No	N/A	N	Y
611	Tower	Twr	No	N/A	Y	Y
612	Town Center	Town Ctr	No	N/A	Y	Y
613	Town Hall	Town Hall	No	N/A	N	Y
614	Town Highway	Town Hwy	No	N/A	Y	N
615	Town Road	Town Rd	No	N/A	Y	N
616	Towne Center	Towne Ctr	No	N/A	Y	Y
617	Township Highway	Twp Hwy	No	N/A	Y	N
618	Township Road	Twp Rd	No	N/A	Y	N
619	Trace	Trce	No	N/A	N	Y
620	Track	Trak	No	N/A	Y	Y
621	Trafficway	Trfy	No	N/A	N	Y
622	Trail	Trl	No	N/A	Y	Y
623	Trailer Court	Trailer Ct	No	N/A	N	Y
624	Trailer Park	Trailer Pk	No	N/A	N	Y
628	Transmission Line	Trans Ln	No	N/A	N	Y
702	Treatment Plant	Trmt Plant	No	N/A	Y	Y
630	Tribal Road	Tribal Rd	No	N/A	Y	N
632	Trolley	Trolley	No	N/A	Y	Y

Type Code	Expanded Full Text	Display Name abbreviation	Spanish	Spanish Translation	Prefix Type	Suffix Type
633	Truck Trail	Truck Trl	No	N/A	Y	Y
636	Túnel	Túnel	Yes	Tunnel	Y	N
634	Tunnel	Tunl	No	N/A	Y	Y
635	Turnpike	Tpke	No	N/A	N	Y
637	Underpass	Upas	No	N/A	Y	Y
642	Universidad	Universidad	Yes	University or College	Y	N
643	University	Univ	No	N/A	Y	Y
638	US Forest Service Highway	USFS Hwy	No	N/A	Y	N
639	US Forest Service Road	USFS Rd	No	N/A	Y	N
640	US Highway	US Hwy	No	N/A	Y	N
641	US Route	US Rte	No	N/A	Y	N
644	Valley	Vly	No	N/A	N	Y
645	Vereda	Ver	Yes	Path	Y	N
655	Via	Via	Yes	Way	Y	N
646	Viaduct	Viaduct	No	N/A	N	Y
647	View	Vw	No	N/A	N	Y
648	Villa	Villa	No	N/A	Y	Y
649	Village	Vlg	No	N/A	Y	Y
650	Village Center	Village Ctr	No	N/A	Y	Y
697	Vineyard	Vineyard	No	N/A	N	Y
652	Vineyards	Vineyards	No	N/A	N	Y
654	Vista	Vis	Yes	View	Y	Y
656	Walk	Walk	No	N/A	N	Y
657	Walkway	Walkway	No	N/A	N	Y
659	Wash	Wash	No	N/A	N	Y
660	Waterway	Waterway	No	N/A	N	Y
661	Way	Way	No	N/A	N	Y
663	Wharf	Wharf	No	N/A	N	Y
665	Wild and Scenic River	Wild n Snc Riv	No	N/A	N	Y
664	Wild River	Wild River	No	N/A	N	Y
666	Wilderness	Wilderness	No	N/A	N	Y
667	Wilderness Park	Wilderenss Pk	No	N/A	N	Y
668	Wildlife Management Area	Wldlf Mgt Area	No	N/A	N	Y
669	Winery	Winery	No	N/A	Y	Y
672	Yard	Yard	No	N/A	N	Y
673	Yards	Yards	No	N/A	Y	Y
670	YMCA	YMCA	No	N/A	Y	Y
671	YWCA	YWCA	No	N/A	Y	Y

Type Code	Expanded Full Text	Display Name abbreviation	Spanish	Spanish Translation	Prefix Type	Suffix Type
675	Zanja	Zanja	Yes	Ditch	Y	N
676	Zoo	Zoo	No	N/A	Y	Y

Figure 76: Appendix D: Feature Name Types

Appendix E. 2020 MAF/TIGER Feature Class Code (MTFCC) Definitions

See <https://www2.census.gov/geo/pdfs/reference/mtfccs2019.pdf> for further information.

MTFCC	Feature Class	Superclass	Point	Linear	Areal	Feature Class Description
C3022	Mountain Peak or Summit	Miscellaneous Topographic Features	Y	N	N	A prominent elevation rising above the surrounding level of the Earth's surface.
C3023	Island	Miscellaneous Topographic Features	Y	Y	Y	An area of dry or relatively dry land surrounded by water or low wetland (e.g., archipelago, atoll, cay, hammock, hummock, isla, isle, key, moku, and rock).
C3024	Levee	Miscellaneous Topographic Features	N	Y	Y	An embankment flanking a stream or other flowing water feature to prevent overflow.
C3026	Quarry (not water-filled), Open Pit Mine or Mine	Miscellaneous Topographic Features	Y	N	Y	An area from which commercial minerals are (or were) removed from the Earth; not including an oilfield or gas field.
C3027	Dam	Miscellaneous Topographic Features	Y	Y	Y	A barrier built across the course of a stream to impound water and/or control water flow.
C3061	Cul-de-sac	Miscellaneous Topographic Features	Y	N	N	An expanded paved area at the end of a street used by vehicles for turning around. The placement of addressed structures located along the street may wrap around the end of the cul-de-sac.
C3062	Traffic Circle	Miscellaneous Topographic Features	Y	N	N	A circular intersection allowing for continuous movement of traffic at the meeting of roadways, when the circle shows as a point.
C3066	Gate	Miscellaneous Topographic Features	Y	N	N	A movable barrier across a road.
C3067	Toll Booth	Miscellaneous Topographic Features	Y	N	N	A structure or barrier where a fee is collected for using a road.
C3071	Tower	Miscellaneous Topographic Features	Y	N	N	A manmade structure, higher than its diameter, generally used for observation, storage, or electronic transmission.

MTFCC	Feature Class	Superclass	Point	Linear	Areal	Feature Class Description
C3074	Lighthouse Beacon	Miscellaneous Topographic Features	Y	N	N	A manmade structure, higher than its diameter, used to transmit light and possibly sound generally to aid in navigation.
C3075	Tank/Tank Farm	Miscellaneous Topographic Features	Y	N	Y	One or more manmade structures, used for liquid or gas storage or for distribution activities.
C3076	Windmill Farm	Miscellaneous Topographic Features	Y	N	Y	A facility where power generation is from the wind.
C3077	Solar Farm	Miscellaneous Topographic Features	Y	N	Y	A facility where power generation is from the sun.
C3078	Monument or Memorial	Miscellaneous Topographic Features	Y	N	N	A manmade structure to educate, commemorate, or memorialize an event, person, or feature.
C3079	Boundary Monument Point	Miscellaneous Topographic Features	Y	N	N	A locational marker or monument placed on or near a boundary line to preserve and identify the location of the boundary line on the ground.
C3080	Survey Control Point	Miscellaneous Topographic Features	Y	N	N	A point on the ground is a known position (horizontal or vertical) and a base for additional survey work.
C3081	Locality Point	Miscellaneous Topographic Features	Y	N	N	A point that identifies the location and name of a locality (e.g., crossroad, community, populated place or locale) that usually does not have a formally established boundary.
C3085	Alaska Native Village Official Point	Miscellaneous Topographic Features	Y	N	N	A point that serves as the core of an Alaska Native village and used in defining Alaska Native village statistical areas.
G1000	Nation	Tabulation Area	N	N	Y	This feature represents sovereign states recognized by the U.S. Department of State. For Census Bureau purposes, the area for which the decennial census covers, which is the United States, Puerto Rico, and the Island Areas (American Samoa, Guam, the Commonwealth of the Northern Mariana Islands, and the U.S. Virgin Islands). The feature may also include other sovereign states (e.g., Canada and Mexico), but currently does not do so.

MTFCC	Feature Class	Superclass	Point	Linear	Areal	Feature Class Description
G1100	Census Region	Tabulation Area	N	N	Y	A grouping of states and the District of Columbia for the presentation of census data. The United States has four Census Regions—Northeast, South, Midwest, and West.
G1200	Census Division	Tabulation Area	N	N	Y	A grouping of states and the District of Columbia that is a subdivision of the four Census Regions.
G2100	American Indian Area (AIA)	American Indian, Alaska Native, or Native Hawaiian Area	N	N	Y	A legally defined state- or federally recognized reservation and/or off-reservation trust land entity (excluding statistical American Indian and Alaska Native areas).
G2120	Hawaiian home land (HHL)	American Indian, Alaska Native, or Native Hawaiian Area	N	N	Y	A legal area held in trust for the benefit of Native Hawaiians by Hawaii, pursuant to the Hawaiian Homes Commission Act of 1920, as amended.
G2130	Alaska Native Village Statistical Area (ANVSA)	American Indian, Alaska Native, or Native Hawaiian Area	N	N	Y	A statistical area that represents the more densely settled portion of Alaska Native villages (ANVs), which constitute associations, bands, clans, communities, groups, tribes, or villages recognized pursuant to the Alaska Native Claims Settlement Act of 1971 (Public Law 92-203).
G2140	Oklahoma Tribal Statistical Area (OTSA)	American Indian, Alaska Native, or Native Hawaiian Area	N	N	Y	A statistical entity identified and delineated by the Census Bureau in consultation with federally recognized American Indian tribes that have no current reservation, but had a former reservation in Oklahoma.
G2150	State-Designated Tribal Statistical Area (SDTSA)	American Indian, Alaska Native, or Native Hawaiian Area	N	N	Y	A statistical geographic entity identified and delineated for the Census Bureau by a state-appointed liaison for a state-recognized American Indian tribe that does not currently have a reservation and/or lands in trust.
G2160	Tribal Designated Statistical Area (TDSA)	American Indian, Alaska Native, or Native Hawaiian Area	N	N	Y	A statistical geographic entity identified and delineated for the Census Bureau by a federally recognized American Indian tribe that does not currently have a reservation and/or off-reservation trust land.

MTFCC	Feature Class	Superclass	Point	Linear	Areal	Feature Class Description
G2170	American Indian Joint-Use Area (AIJUA)	American Indian, Alaska Native, or Native Hawaiian Area	N	N	Y	An area administered jointly and/or claimed by two or more American Indian tribes.
G2200	Alaska Native Regional Corporation	Tabulation Area	N	N	Y	Corporate entities with legal boundaries established to conduct both business and nonprofit affairs of Alaska Natives pursuant to the Alaska Native Claims Settlement Act of 1972 (Public Law 92-203). There are twelve geographically defined ANRCs are all within and cover most of Alaska (the Annette Island Reserve—an American Indian Reservation—is excluded from any ANRC).
G2300	Tribal Subdivision	Tabulation Area	N	N	Y	Administrative subdivisions of federally recognized American Indian Reservations, off-reservation trust lands, or Oklahoma Tribal Statistical Areas (OTSAs). These entities are internal units of self-government or administration that serve social, cultural, and/or economic purposes for the American Indians on the reservations, Off-Reservation Trust Lands (ORTLs).
G2400	Tribal Census Tract	Tabulation Area	N	N	Y	A relatively small and permanent statistical subdivision of a federally recognized American Indian Reservation and/or off-reservation trust land, delineated by American Indian tribal participants or the Census Bureau for the purpose of presenting demographic data.
G2410	Tribal Block Group	Tabulation Area	N	N	Y	A cluster of census blocks within a single tribal census tract delineated by American Indian tribal participants or the Census Bureau for presenting demographic data.
G3100	Combined Statistical Area	Tabulation Area	N	N	Y	A grouping of adjacent metropolitan and/or micropolitan statistical areas that have a degree of economic and social integration, as measured by commuting.

MTFCC	Feature Class	Superclass	Point	Linear	Areal	Feature Class Description
G3110	Metropolitan and Micropolitan Statistical Area	Tabulation Area	N	N	Y	An area containing a substantial population nucleus together with adjacent communities having a high degree of economic and social integration with that core, as measured by commuting. Each area is using whole counties and equivalents.
G3120	Metropolitan Division	Tabulation Area	N	N	Y	A county or grouping of counties that is a subdivision of a Metropolitan Statistical Area containing an urbanized area with a population of 2.5 million or more.
G3200	Combined New England City and Town Area	Tabulation Area	N	N	Y	A grouping of adjacent New England city and town areas that have a degree of economic and social integration, as measured by commuting.
G3210	New England City and Town Metropolitan and Micropolitan Statistical Area	Tabulation Area	N	N	Y	An area containing a substantial population nucleus together with adjacent communities having a high degree of economic and social integration with that core, as measured by commuting. Each area is using Minor Civil Divisions (MCDs) in New England.
G3220	New England City and Town Division	Tabulation Area	N	N	Y	A grouping of cities and towns in New England that is a subdivision of a New England City and Town Area containing an urbanized area with a population of 2.5 million or more.
G3500	Urban Area	Tabulation Area	N	N	Y	Densely settled territory that contains 2,500 people. The subtypes of this feature are Urbanized Area (UA), which consists of 50,000 + people and Urban Cluster of 2,500 to 49,999 people.
G4000	State or Equivalent Feature	Tabulation Area	N	N	Y	The primary governmental divisions of the United States. The statistical equivalent of a state for census purposes are District of Columbia, Puerto Rico, American Samoa, Guam, the Commonwealth of the Northern Mariana Islands, and the U.S. Virgin Islands.

MTFCC	Feature Class	Superclass	Point	Linear	Areal	Feature Class Description
G4020	County or Equivalent Feature	Tabulation Area	N	N	Y	The primary division of a state or state equivalent area. The primary divisions of 48 states are termed County, but other terms are used (e.g., Borough in Alaska, Parish in Louisiana, and Municipio in Puerto Rico). This feature includes independent cities, which are incorporated places that are not part of any county.
G4040	County Subdivision	Tabulation Area	N	N	Y	The primary divisions of counties and equivalent features for the reporting of Census Bureau data. The subtypes of this feature are Minor Civil Division, Census County Division/Census Subarea, and Unorganized Territory. This feature includes independent places, which are incorporated places that are not part of any county subdivision.
G4050	Estate	Tabulation Area	N	N	Y	A subdivision of the three major islands in the U.S. Virgin Islands (USVI). The estates have legally defined boundaries and are much smaller in area than the Census Subdistricts (USVI county subdivisions), but do not necessarily nest within these districts.
G4060	Sub-Minor Civil Division	Tabulation Area	N	N	Y	Legally defined divisions (subbarrios) of minor civil divisions (barrios-pueblo and barrios) in Puerto Rico.
G4110	Incorporated Place	Tabulation Area	N	N	Y	A legal entity incorporated under state law to provide general-purpose governmental services to a concentration of population. Incorporated places usually is a city, borough, municipality, town, village, or have a different legal description.
G4120	Consolidated City	Tabulation Area	N	N	Y	An Incorporated Place that has merged governmentally with a county or minor civil division, but one or more of the incorporated places continues to function within the consolidation. A consolidated city is a place that contains additional separately incorporated places.

MTFCC	Feature Class	Superclass	Point	Linear	Areal	Feature Class Description
G4210	Census Designated Place	Tabulation Area	N	N	Y	A statistical area for a named concentration of population and is the statistical counterpart of an incorporated place.
G4300	Economic Census Place	Tabulation Area	N	N	Y	The lowest level of geographic area for presentation of some types of Economic Census data. Economic Census Place includes incorporated places, consolidated cities, Census Designated Places (CDPs), Minor Civil Divisions (MCDs) in selected states, and balances of MCDs or counties. An Incorporated Place, CDP, MCD, or balance of MCD qualifies as an Economic Census Place if has 2,500 or more residents, or 2,500 or more jobs, according to the most current data available.
G5020	Census Tract	Tabulation Area	N	N	Y	Relatively permanent statistical subdivisions of a County or equivalent feature delineated by local participants as part of the Census Bureau's Participant Statistical Areas Program.
G5030	Block Group	Tabulation Area	N	N	Y	A cluster of census blocks having the same first digit of their four-digit identifying numbers within a Census Tract. For example, block group 3 (BG 3) within a Census Tract includes all blocks numbered from 3000 to 3999.
G5040	Tabulation Block	Tabulation Area	N	N	Y	The lowest-order census defined statistical area. Tabulation Block is an area (e.g., city block), bounded primarily by physical features but sometimes by invisible city or property boundaries. A tabulation block boundary does not cross the boundary of any other geographic area for which the Census Bureau tabulates data. The subtypes of this feature are Count Question Resolution (CQR), current and tabulation census.

MTFCC	Feature Class	Superclass	Point	Linear	Areal	Feature Class Description
G5200	Congressional District	Tabulation Area	N	N	Y	The 435 areas from which people elect their voting delegates to the U.S. House of Representatives. Additional equivalent features exist for state equivalents with nonvoting delegates or no representative. The subtypes of this feature are 111th, 113th, 114th, 115th, 116th, 117th, and 118th Congressional Districts, plus subsequent Congresses.
G5210	State Legislative District (Upper Chamber)	Tabulation Area	N	N	Y	Areas established by a state or equivalent government where voters elect a person to represent them in the upper or unicameral chamber of a state governing body. The upper chamber is the senate in a bicameral legislature, and the unicameral case is a single house legislature (Nebraska). The subtypes of this feature are legislative session year (e.g., 2010, 2012, 2014, 2016, 2017, 2018, 2020, etc.), with the year indicating the vintage of the district.
G5220	State Legislative District (Lower Chamber)	Tabulation Area	N	N	Y	Areas established by a state or equivalent government where voters elect a person to represent them in the lower chamber of a state governing body. The lower chamber is the House of Representatives in a bicameral legislature. The subtypes of this feature are legislative session year (e.g., 2010, 2012, 2014, 2016, 2017, 2018, 2020, etc.), with the year indicating the vintage of the district.
G5240	Voting District	Tabulation Area	N	N	Y	The generic name for the geographic features (e.g., precincts, wards, and election districts), established by state, local and tribal governments to conduct elections.
G5400	Elementary School District	Tabulation Area	N	N	Y	A geographic area within which officials provide public elementary grade-level educational services for residents.
G5410	Secondary School District	Tabulation Area	N	N	Y	A geographic area within which officials provide public secondary grade-level educational services for residents.

MTFCC	Feature Class	Superclass	Point	Linear	Areal	Feature Class Description
G5420	Unified School District	Tabulation Area	N	N	Y	A geographic area within which officials provide public educational services for all grade levels for residents.
G6120	Public Use Microdata Area (PUMA)	Tabulation Area	N	N	Y	A decennial census area with a population of 100,000 for which the Census Bureau provides selected extracts of household-level data from a 5% sample of long-form Census Bureau records that are screened to protect confidentiality. In Guam and the U.S. Virgin Islands, the extracts are from a 10% sample.
G6300	Traffic Analysis District	Tabulation Area	N	N	Y	An area delineated by Metropolitan Planning Organizations (MPOs) and state Departments of Transportation (DOTs) for tabulating journey-to-work and place-of-work data. A Traffic Analysis District (TAD) consists of one or more Traffic Analysis Zones (TAZs).
G6320	Traffic Analysis Zone	Tabulation Area	N	N	Y	An area delineated by state and/or local transportation officials and Metropolitan Planning Organizations (MPOs) for tabulating journey-to-work and place-of-work data.
G6330	Urban Growth Area	Tabulation Area	N	N	Y	An area defined under state authority to manage urbanization that the Census Bureau includes in its products in agreement with an individual state.
G6350	Zip Code Tabulation Area (Five-Digit)	Tabulation Area	N	N	Y	An approximate statistical-area representation of a U.S. Postal Service (USPS) 5-digit ZIP Code service area.
G6400	Planning Region	Tabulation Area	N	N	Y	A grouping of municipios defined by Puerto Rico officials for the purpose of presenting economic census statistical data.
H1100	Connector	Hydrographic Features	N	Y	N	A known, but nonspecific, hydrographic connection between two nonadjacent water features.
H2030	Lake/Pond	Hydrographic Features	N	N	Y	A standing body of water surrounded by land.
H2040	Reservoir	Hydrographic Features	N	N	Y	An artificially impounded body of water.
H2041	Treatment Pond	Hydrographic Features	N	N	Y	An artificial body of water built to treat fouled water.

MTFCC	Feature Class	Superclass	Point	Linear	Areal	Feature Class Description
H2051	Bay/Estuary/Gulf/Sound	Hydrographic Features	N	N	Y	A body of water partly surrounded by land (e.g., arm, bight, cove, and inlet).
H2053	Ocean/Sea	Hydrographic Features	N	N	Y	The great body of salt water that covers much of the earth.
H2060	Gravel Pit/Quarry filled with water	Hydrographic Features	N	N	Y	A body of water in a place or area where commercial minerals were removed from the Earth.
H2081	Glacier	Hydrographic Features	N	N	Y	A body of ice moving outward and down slope from an area of accumulation. An area of relatively permanent snow or ice on the top or side of a mountain or mountainous area (includes ice field and ice patch).
H3010	Stream/River	Hydrographic Features	N	Y	Y	A natural flowing waterway (includes anabranch, awawa, branch, brook, creek, distributary, fork, kill, pup, rio, and run).
H3013	Braided Stream	Hydrographic Features	N	Y	Y	A natural flowing waterway with an intricate network of interlacing channels.
H3020	Canal, Ditch, or Aqueduct	Hydrographic Features	N	Y	Y	An artificial waterway constructed to transport water, to irrigate or drain land, to connect two or more bodies of water, or to serve as a waterway for watercraft (includes lateral).
K1121	Apartment Building or Complex	Potential Living Quarters	N	N	Y	A building complex that contains multiple living quarters generally for which rent is paid.
K1223	Trailer Court or Mobile Home Park	Potential Living Quarters	N	N	Y	A parking space area for rented house trailers, usually providing utilities and services.
K1225	Crew-of-Vessel Location	Potential Living Quarters	Y	N	Y	A point or area in which the population of military or merchant marine vessels at sea are assigned, usually being at or near the home port pier.
K1226	Housing Facility/Dormitory for Workers	Potential Living Quarters	N	N	Y	A facility providing housing for a number of persons employed as semi-permanent or seasonal laborers.
K1227	Hotel, Motel, Resort, Spa, Hostel, YMCA, or YWCA	Potential Living Quarters	N	N	Y	A facility providing transient lodging or living quarters, generally for some payment.

MTFCC	Feature Class	Superclass	Point	Linear	Areal	Feature Class Description
K1228	Campground	Potential Living Quarters	N	N	Y	An area used for setting up mobile temporary living quarters (camp) or holding a camp meeting, sometimes providing utilities and other amenities.
K1229	Shelter or Mission	Potential Living Quarters	N	N	Y	A facility providing low-cost or free living quarters established by a welfare or educational organization for the needy people of a district.
K1231	Hospital/Hospice/Urgent Care Facility	Potential Living Quarters	Y	N	Y	A facility where the sick or injured may receive medical or surgical attention (including infirmary).
K1233	Nursing Home, Retirement Home, or Home for the Aged	Potential Living Quarters	N	N	Y	A facility to house and provide care for the elderly.
K1235	Juvenile Institution	Potential Living Quarters	N	N	Y	A facility (correctional or non-correctional) where groups of juveniles reside; this includes training schools, detention centers, residential treatment centers and orphanages.
K1236	Local Jail or Detention Center	Potential Living Quarters	Y	N	Y	A facility that serves as a place for the confinement of adult persons in lawful detention, administered by a local (tribal, county, municipal, etc.) government.
K1237	Federal Penitentiary, State Prison, or Prison Farm	Potential Living Quarters	Y	N	Y	A facility that serves as a place for the confinement of adult persons in lawful detention, administered by the federal government or a state government.
K1238	Other Correctional Institution	Potential Living Quarters	Y	N	Y	A facility that serves as a place for the confinement of adult persons in lawful detention, not elsewhere classified or administered by a government of unknown jurisdiction.
K1239	Convent, Monastery, Rectory, Other Religious Group Quarters	Potential Living Quarters	Y	N	Y	An institution intended for residential use by those having a religious vocation.
K2100	Governmental	Workplaces	N	N	Y	A place where employees work in federal, state, local or tribal government.
K2110	Military Installation	Governmental	Y	N	Y	An area owned and/or occupied by the Department of Defense for use by a branch of the armed forces (e.g., Army, Navy, Air Force, Marines, or Coast Guard), or a state owned area for the use of the National Guard.

MTFCC	Feature Class	Superclass	Point	Linear	Areal	Feature Class Description
K2146	Community Center	Governmental	Y	N	Y	A meeting place used by members of a community for social, cultural, or recreational purposes.
K2165	Government Center	Governmental	Y	N	Y	A place used by members of government (either federal, state, local, or tribal) for administration and public business.
K2167	Convention Center	Governmental	Y	N	Y	An exhibition hall or conference center with enough open space to host public and private business and social events.
K2180	Park	Governmental	N	N	Y	A place or area set aside for recreation or preservation of a cultural or natural resource.
K2181	National Park Service Land	Park	Y	N	Y	Land under the jurisdiction of the National Park Service, including National Parks, most National Monuments and certain other lands.
K2182	National Forest or Other Federal Land	Park	Y	N	Y	Land under the jurisdiction of the U.S. Forest Service or other federal agency, excluding National Park Service land.
K2183	Tribal Park, Forest, or Recreation Area	Park	Y	N	Y	A place or area set aside for recreation or preservation of a cultural or natural resource and under the administration of an American Indian tribe.
K2184	State Park, Forest, or Recreation Area	Park	Y	N	Y	A place or area set aside for recreation or preservation of a cultural or natural resource and under the administration of a state government.
K2185	Regional Park, Forest, or Recreation Area	Park	Y	N	Y	A place or area set aside for recreation or preservation of a cultural or natural resource and under the administration of a regional government.
K2186	County Park, Forest, or Recreation Area	Park	Y	N	Y	A place or area set aside for recreation or preservation of a cultural or natural resource and under the administration of a county government.
K2187	County Subdivision Park, Forest, or Recreation Area	Park	Y	N	Y	A place or area set aside for recreation or preservation of a cultural or natural resource and under the administration of a minor civil division (town/township) government.

MTFCC	Feature Class	Superclass	Point	Linear	Areal	Feature Class Description
K2188	Incorporated Place Park, Forest, or Recreation Area	Park	Y	N	Y	A place or area set aside for recreation or preservation of a cultural or natural resource and under the administration of a municipal government.
K2189	Private Park, Forest, or Recreation Area	Park	Y	N	Y	A privately owned place or area set aside for recreation or preservation of a cultural or natural resource.
K2190	Other Park, Forest, or Recreation Area (quasi-public, independent park commission, etc.)	Park	Y	N	Y	A place or area set aside for recreation or preservation of a cultural or natural resource and under the administration of some other type of government or agency (e.g., independent park authority or commission).
K2191	Post Office	Governmental	Y	N	N	An official facility of the U.S. Postal Service used for processing and distributing mail and other postal material.
K2193	Fire Department	Governmental	Y	N	N	A facility that houses equipment and personnel to fight fires and provide other assistance.
K2194	Police Station	Governmental	Y	N	N	A facility that is the headquarters for law enforcement officers.
K2195	Library	Governmental	Y	N	N	A facility in which literary, musical, artistic, or reference materials stored for public use.
K2196	City/Town Hall	Governmental	Y	N	N	A facility that houses the chief administrative offices of a local municipal government.
K2300	Commercial Workplace	Workplaces	N	N	Y	A place of employment for wholesale, retail, or other trade.
K2361	Shopping Center or Major Retail Center	Commercial Workplace	N	N	Y	A group of retail establishments within a planned subdivision sharing a common parking area.
K2362	Industrial Building or Industrial Park	Commercial Workplace	N	N	Y	One or more manufacturing establishments within an area zoned for fabrication, construction, or other similar trades.
K2363	Office Building or Office Park	Commercial Workplace	N	N	Y	One or more structures containing employees performing business, clerical, or professional services.
K2364	Farm/Vineyard/Winery/Orchard	Commercial Workplace	N	N	Y	An agricultural establishment where crops are grown and/or animals are raised.

MTFCC	Feature Class	Superclass	Point	Linear	Areal	Feature Class Description
K2366	Other Employment Center	Commercial Workplace	N	N	Y	A place of employment not elsewhere classified or of unknown type.
K2400	Transportation Terminal	Workplaces	Y	N	Y	A facility where one or more modes of transportation is accessible by people or for the shipment of goods (e.g., airport, bus station, marine terminal, train station, and truck warehouse).
K2424	Marina	Transportation Terminal	N	N	Y	A place where privately owned, light-watercraft and/or houseboats are moored.
K2432	Pier/Dock	Transportation Terminal	N	Y	Y	A platform built out from the shore into the water and supported by piles. This platform may provide access to ships and boats or for recreational purposes.
K2451	Airport or Airfield	Transportation Terminal	Y	Y	Y	A manmade facility maintained for the use of aircraft (e.g., airstrip, landing field, and landing strip).
K2452	Train Station, Trolley or Mass Transit Rail Station	Transportation Terminal	Y	N	Y	A place where travelers can board and exit rail transit lines, including associated ticketing, freight, and other commercial offices.
K2453	Bus Terminal	Transportation Terminal	Y	N	Y	A place where travelers can board and exit mass motor vehicle transit, including associated ticketing, freight, and other commercial offices.
K2454	Marine Terminal	Transportation Terminal	Y	N	Y	A place where travelers can board and exit water transit or where cargo is handled, including associated ticketing, freight, and other commercial offices.
K2455	Seaplane Anchorage	Transportation Terminal	Y	N	Y	A place where an airplane equipped with floats for landing on or taking off from a body of water can debark and load.
K2456	Airport—Intermodal Transportation Hub/Terminal	Transportation Terminal	Y	N	Y	A major air transportation facility where travelers can board and exit airplanes and connect with other (i.e. non-air) modes of transportation.
K2457	Airport—Statistical Representation	Transportation Terminal	N	N	Y	The area of an airport adjusted to include whole 2010 tabulation census blocks used for the delineation of urban areas.

MTFCC	Feature Class	Superclass	Point	Linear	Areal	Feature Class Description
K2458	Park and Ride Facility /Parking Lot	Transportation Terminal	Y	N	Y	A place where motorists can park their cars and transfer to other modes of transportation.
K2459	Runway/Taxiway	Transportation Terminal	Y	Y	Y	A level (fairly) and usually paved expanse used by airplanes for taking off and landing at an airport.
K2460	Helicopter Landing Pad	Transportation Terminal	Y	N	Y	A level (fairly) and usually paved expanse used by helicopters for taking off and landing.
K2540	University or College	Other Workplace	Y	N	Y	An institution for post-secondary study, teaching, and learning. [including seminary]
K2543	School or Academy	Other Workplace	Y	N	Y	An institution for preschool, elementary or secondary study, teaching, and learning.
K2545	Museum, Visitor Center, Cultural Center, or Tourist Attraction	Other Workplace	Y	N	Y	An attraction of historical, cultural, educational or other interest that provides information or displays artifacts.
K2561	Golf Course	Other Workplace	Y	N	Y	A public or private facility designed for playing golf.
K2564	Amusement Center	Other Workplace	N	N	Y	A facility that offers entertainment, performances or sporting events (e.g., arena, auditorium, theater, stadium, coliseum, racecourse, theme park, fairgrounds and shooting range).
K2582	Cemetery	Other Workplace	Y	N	Y	A place or area for burying the dead. [including burying ground and memorial garden]
K2586	Zoo	Other Workplace	Y	N	Y	A facility in which terrestrial and/or marine animals are confined within enclosures and displayed to the public for educational, preservation and research purposes.
K3544	Place of Worship	Other Workplace	Y	N	Y	A sanctified place or structure where people gather for religious worship (e.g., church, synagogue, temple and mosque).
L4010	Pipeline	Miscellaneous Linear Features	N	Y	N	A long tubular conduit or series of pipes, often underground, with pumps and valves for flow control, used to transport fluid (e.g., crude oil, natural gas), especially over great distances.

MTFCC	Feature Class	Superclass	Point	Linear	Areal	Feature Class Description
L4020	Powerline	Miscellaneous Linear Features	N	Y	N	One or more wires, often on elevated towers, used for conducting high-voltage electric power.
L4031	Aerial Tramway/Ski Lift	Miscellaneous Linear Features	N	Y	N	A conveyance that transports passengers or freight in carriers suspended from cables and supported by a series of towers.
L4110	Fence Line	Miscellaneous Linear Features	N	Y	N	A manmade barrier enclosing or bordering a field, yard, etc., usually made of posts and wire or wood, used to prevent entrance, to confine, or to mark a boundary.
L4121	Ridge Line	Miscellaneous Linear Features	N	Y	N	The line of highest elevation along a ridge.
L4125	Cliff/Escarpment	Miscellaneous Linear Features	N	Y	N	A very steep or vertical slope (e.g., bluff, crag, head, headland, nose, palisades, precipice, promontory, rim, and rimrock.)
L4130	Point-to-Point Line	Miscellaneous Linear Features	N	Y	N	A line defined as beginning at one location point and ending at another, where each of these points is usually in sight of the other and no structures are in proximity to the line. This includes straight-line, nonvisible, 180-degree extensions off the ends of a terminating linear feature.
L4140	Property/Parcel Line (Including PLSS)	Miscellaneous Linear Features	N	Y	N	A cadastral boundary line separating two distinct real property parcels or a Public Land Survey System or equivalent survey line.
L4150	Coastline	Miscellaneous Linear Features	N	Y	N	The line that separates either land or Inland water from Coastal, Territorial or Great Lakes water. Where land directly borders Coastal, Territorial or Great Lakes water, the shoreline represents the Coastline. Where Inland water (e.g., river) flows into Coastal, Territorial or Great Lakes water, the closure line separating the Inland water from the other class of water represents the Coastline.
L4165	Ferry Crossing	Miscellaneous Linear Features	N	Y	N	A nonvisible feature defining the route used to carry or convey people or cargo back and forth over a waterbody in a boat.

MTFCC	Feature Class	Superclass	Point	Linear	Areal	Feature Class Description
P0001	Nonvisible Linear Legal/Statistical Boundary	Bounding Edges and Non-Feature Edges	N	Y	N	A legal/statistical boundary line that does not correspond to a shoreline or other visible feature on the ground.
P0002	Perennial Shoreline	Bounding Edges and Non-Feature Edges	N	Y	N	The more-or-less permanent boundary between land and water for a water feature that exists year-round.
P0003	Intermittent Shoreline	Bounding Edges and Non-Feature Edges	N	Y	N	The boundary between land and water (when water is present) for a water feature that does not exist year-round.
P0004	Other Non-Visible Edge	Bounding Edges and Non-Feature Edges	N	Y	N	An edge that does not represent a legal/statistical boundary, and does not correspond to a shoreline or other visible feature on the ground. Many such edges bound area landmarks, while many others separate water features from each other (e.g., where a bay meets the ocean).
R1011	Railroad Feature (Main, Spur, or Yard)	Rail Features	N	Y	N	A line of fixed rails or tracks that carries mainstream railroad traffic. Such a rail line can be a main line or spur line, or part of a rail yard.
R1051	Carline, Streetcar Track, Monorail, Other Mass Transit Rail	Rail Features	N	Y	N	Mass transit rail lines (including lines for rapid transit, monorails, streetcars, light rail, etc.) that are typically inaccessible to mainstream railroad traffic and whose tracks are not part of a road right-of-way.
R1052	Cog Rail Line, Incline Rail Line, Tram	Rail Features	N	Y	N	A special purpose rail line for climbing steep grades that is typically inaccessible to mainstream railroad traffic. Note that aerial tramways and streetcars (which may be called "trams") are accounted for by other MTFCCs and do not belong in R1052.

MTFCC	Feature Class	Superclass	Point	Linear	Areal	Feature Class Description
S1100	Primary Road	Road/Path Features	N	Y	N	Primary roads are limited-access highways that connect to other roads only at interchanges and not at at-grade intersections. This category includes Interstate highways, as well as all other highways with limited access (some of which are toll roads). Limited-access highways with only one lane in each direction, as well as those that are undivided are also included under S1100.
S1200	Secondary Road	Road/Path Features	N	Y	N	Secondary roads are main arteries that are not limited access, usually in the U.S. highway, state highway, or county highway systems. These roads have one or more lanes of traffic in each direction, may or may not be divided, and usually have at-grade intersections with many other roads and driveways. Secondary roads often have both a local name and a route number.
S1400	Local Neighborhood Road, Rural Road, City Street	Road/Path Features	N	Y	N	A paved (privately or publicly maintained) non-arterial street, road, or byway that usually has a single lane of traffic in each direction. Scenic park roads would be included in this feature class, as would (depending on the region of the country) some unpaved roads.
S1500	Vehicular Trail (4WD)	Road/Path Features	N	Y	N	An unpaved dirt trail where a four-wheel drive vehicle is required. These vehicular trails are almost exclusively in very rural areas. Minor, unpaved roads usable by ordinary cars and trucks belong in the S1400 category.
S1630	Ramp	Road/Path Features	N	Y	N	A road that allows controlled access from adjacent roads onto a limited access highway, often in the form of a cloverleaf interchange.
S1640	Service Drive usually along a limited access highway	Road/Path Features	N	Y	N	A road, usually paralleling a limited access highway, providing access to structures and/or service facilities along the highway. These roads can have names and may intersect with other roads.

MTFCC	Feature Class	Superclass	Point	Linear	Areal	Feature Class Description
S1710	Walkway/Pedestrian Trail	Road/Path Features	N	Y	N	A path that is used for walking, being either too narrow for or legally restricted from vehicular traffic.
S1720	Stairway	Road/Path Features	N	Y	N	A pedestrian passageway from one level to another by a series of steps.
S1730	Alley	Road/Path Features	N	Y	N	A service road that does not generally have associated addressed structures. These roads are often unnamed. The service road is located at the rear of buildings and properties and used for deliveries.
S1740	Private Road for service vehicles (logging, oil fields, ranches, etc.)	Road/Path Features	N	Y	N	A privately maintained road within private property for service, extractive or other purposes. These roads are often unnamed.
S1750	Internal Census Bureau use	Road/Path Features	N	Y	N	Internal Census Bureau use.
S1780	Parking Lot Road	Road/Path Features	N	Y	N	The main travel route for vehicles through a paved parking area. This may include unnamed roads through apartment, condominium, office complexes where pull-in parking spaces line the road.
S1820	Bike Path or Trail	Road/Path Features	N	Y	N	A path that is for manual or small, motorized bicycles, being either too narrow for or legally restricted from vehicular traffic.
S1830	Bridle Path	Road/Path Features	N	Y	N	A path that is for horses, being either too narrow for or legally restricted from vehicular traffic.

Figure 77: Appendix E: MTFCC Definitions

Appendix F. Record Layouts: American Indian, Alaska Native, Native Hawaiian

Appendix F-1. Record Layout: ANRC Shapefile

Alaska Native Regional Corporation (ANRC) Shapefile Record Layout

File Name: tl_YYYY_02_anrc.shp

Field	Length	Type	Description
STATEFP	2	String	Current state FIPS code
ANRCFP	5	String	Current Alaska Native Regional Corporation FIPS code
ANRCNS	8	String	ANSI feature code for Alaska Native Regional Corporation
GEOID	7	String	Alaska Native Regional Corporation identifier; a concatenation of Current state FIPS code and Alaska Native Regional Corporation code
NAME	100	String	Current Alaska Native Regional Corporation name
NAMELSAD	100	String	Current name and the translated legal/statistical area description for Alaska Native Regional Corporation
LSAD	2	String	Current legal/statistical area description code for Alaska Native Regional Corporation
CLASSFP	2	String	Current FIPS class code
MTFCC	5	String	MAF/TIGER Feature Class Code (G2200)
FUNCSTAT	1	String	Current functional status
ALAND	14	Number	Current land area
AWATER	14	Number	Current water area
INTPTLAT	11	String	Current latitude of the internal point
INTPTLON	12	String	Current longitude of the internal point

Figure 78: Appendix F-1: ANRC Shapefile Record Layout

Appendix F-2. Record Layout: AIANNH Shapefile

American Indian, Alaska Native, Native Hawaiian (AIANNH) Area National Shapefile Record Layout

File Name: tl_YYYY_us_aiannh.shp

Field	Length	Type	Description
AIANNHCE	4	String	Current American Indian/Alaska Native/Native Hawaiian area census code
AIANNHNS	8	String	An eight-character ANSI numeric identifier for American Indian/Alaska Native/Native Hawaiian Areas
GEOID	5	String	American Indian/Alaska Native/Native Hawaiian area identifier; a concatenation of Current American Indian/Alaska Native/Native Hawaiian area census code and reservation/statistical area or off-reservation trust land Hawaiian home land indicator
NAME	100	String	Current American Indian/Alaska Native/Native Hawaiian area name
NAMELSAD	100	String	Current name and the translated legal/statistical area description for American Indian/Alaska Native/Native Hawaiian area
LSAD	2	String	Current legal/statistical area description code for American Indian/Alaska Native/Native Hawaiian area
CLASSFP	2	String	Current FIPS class code
COMPTYP	1	String	Current American Indian/Alaska Native/Native Hawaiian area reservation/statistical area or off-reservation trust land Hawaiian home land indicator
AIANNHR	1	String	Current American Indian/Alaska Native/Native Hawaiian area federal/state recognition flag
MTFCC	5	String	MAF/TIGER Feature Class Code
FUNCSTAT	1	String	Current functional status
ALAND	14	Number	Current land area
AWATER	14	Number	Current water area
INTPTLAT	11	String	Current latitude of the internal point
INTPTLON	12	String	Current longitude of the internal point

Figure 79: Appendix F-2: AIANNH Shapefile Record Layout

Appendix F-3. Record Layout: AITS Shapefile

American Indian Tribal Subdivision (AITS) National Shapefile Record Layout

File Name: tl_YYYY_us_aitns.shp

Field	Length	Type	Description
AIANNHCE	4	String	Current American Indian, Alaska Native, Native Hawaiian area census code
TRSUBCE	3	String	Current American Indian Tribal Subdivision census code
TRSUBNS	8	String	ANSI feature code for American Indian Tribal Subdivision
GEOID	7	String	American Indian Tribal Subdivision identifier; a concatenation of Current American Indian/Alaska Native/Native Hawaiian area census code and American Indian tribal subdivision census code
NAME	100	String	Current American Indian Tribal Subdivision name
NAMELSAD	100	String	Current name and the translated legal/statistical area description for American Indian tribal subdivision
LSAD	2	String	Current legal/statistical area description code for American Indian Tribal Subdivision
CLASSFP	2	String	Current FIPS class code
MTFCC	5	String	MAF/TIGER Feature Class Code (G2300)
FUNCSTAT	1	String	Current functional status
ALAND	14	Number	Current land area
AWATER	14	Number	Current water area
INTPTLAT	11	String	Current latitude of the internal point
INTPTLON	12	String	Current longitude of the internal point

Figure 80: Appendix F-3: AITS Shapefile Record Layout

Appendix F-4. Record Layout: Tribal Census Tract Shapefile

Tribal Census Tract National Shapefile (Current)

File Name: tl_YYYY_us_ttract.shp

Field	Length	Type	Description
AIANNHCE	4	String	Current American Indian/Alaska Native/Native Hawaiian area census code
TTRACTCE	6	String	Current tribal census tract code
GEOID	10	String	Tribal census tract identifier; a concatenation of the American Indian Area census code and tribal census tract code
NAME	7	String	Current tribal census tract name, including the decimal point and decimal digits if a non-zero census tract suffix exists
NAMELSAD	27	String	Current translated legal/statistical area description and the tribal census tract name
MTFCC	5	String	MAF/TIGER Feature Class Code (G2400)
ALAND	14	Number	Current land area
AWATER	14	Number	Current water area
INTPTLAT	11	String	Current latitude of the internal point
INTPTLON	12	String	Current longitude of the internal point

Figure 81: Appendix F-4: Tribal Census Tract Shapefile Record Layout

Appendix F-5. Record Layout: Tribal Block Group Shapefile

Tribal Block Group National Shapefile (Current)

File Name: tl_YYYY_us_tbg.shp

Field	Length	Type	Description
AIANNHCE	4	String	Current Census American Indian/Alaska Native/Native Hawaiian area census code
TTRACTCE	6	String	Current tribal census tract code
TBLKGPCE	1	String	Current tribal block group letter

Field	Length	Type	Description
GEOID	11	String	Tribal block group identifier; a concatenation of the Current American Indian/Alaska Native/Native Hawaiian area census code, tribal census tract code, and tribal block group letter
NAMELSAD	20	String	Current translated legal/statistical area description and the tribal block group letter
MTFCC	5	String	MAF/TIGER Feature Class Code (G2410)
ALAND	14	Number	Current land area
AWATER	14	Number	Current water area
INTPTLAT	11	String	Current latitude of the internal point
INTPTLON	12	String	Current longitude of the internal point

Figure 82: Appendix F-5: Tribal Block Group Shapefile Record Layout

Appendix G. Record Layouts: Block and Census Tract

Appendix G-1. Record Layout: Block State-based Shapefile

Block State-based Shapefile Record Layout (2010 Geography)

File Name: tl_YYYY_<state FIPS>_tabblock10.shp

Field	Length	Type	Description
STATEFP10	2	String	2010 Census state FIPS code
COUNTYFP10	3	String	2010 Census county FIPS code
TRACTCE10	6	String	2010 Census tract code
BLOCKCE10	4	String	2010 Census tabulation block number
GEOID10	15	String	Census block identifier; a concatenation of 2010 Census state FIPS code, 2010 Census county FIPS code, 2010 Census tract code, and 2010 Census block number
NAME10	10	String	2010 Census tabulation block name; a concatenation of 'Block' and the tabulation block number
MTFCC10	5	String	MAF/TIGER Feature Class Code (G5040)
UR10	1	String	2010 Census urban/rural indicator

Field	Length	Type	Description
UACE10	5	String	2010 Census urban area code
UATYPE	1	String	2010 Census urban area type
FUNCSTAT10	1	String	2010 Census functional status
ALAND10	14	Number	2010 Census land area
AWATER10	14	Number	2010 Census water area
INTPTLAT10	11	String	2010 Census latitude of the internal point
INTPTLON10	12	String	2010 Census longitude of the internal point

Figure 83: Appendix G-1: Block State-based Shapefile Record Layout

Appendix G-2. Record Layout: Block Group State-based Shapefile

Block Group State-based Shapefile Record Layout (Current)

File Name: tl_YYYY_<state FIPS>_bg.shp

Field	Length	Type	Description
STATEFP	2	String	Current state FIPS code
COUNTYFP	3	String	Current county FIPS code
TRACTCE	6	String	Current census tract code
BLKGRPCE	1	String	Current block group number
GEOID	12	String	Census block group identifier; a concatenation of the current state FIPS code, county FIPS code, census tract code, and block group number.
NAMELSAD	13	String	Current translated legal/statistical area description and the block group number
MTFCC	5	String	MAF/TIGER Feature Class Code (G5030)
FUNCSTAT	1	String	Current functional status
ALAND	14	Number	Current land area
AWATER	14	Number	Current water area
INTPTLAT	11	String	Current latitude of the internal point

Field	Length	Type	Description
INTPTLON	12	String	Current longitude of the internal point

Figure 84: Appendix G-2: Block Group State-based Shapefile Record Layout

Appendix G-3. Record Layout: Census Tract State-based Shapefile

Census Tract State-based Shapefile Record Layout (Current)

File Name: tl_YYYY_<state FIPS>_tract.shp

Field	Length	Type	Description
STATEFP	2	String	Current state FIPS code
COUNTYFP	3	String	Current county FIPS code
TRACTCE	6	String	Current census tract code
GEOID	11	String	Census tract identifier; a concatenation of Current state FIPS code, county FIPS code, and census tract code
NAME	7	String	Current census tract name, this is the census tract code converted to an integer or integer with 2-decimals if the last two characters of the code are not both zeros.
NAMELSAD	20	String	Current translated legal/statistical area description and the census tract name
MTFCC	5	String	MAF/TIGER Feature Class Code (G5020)
FUNCSTAT	1	String	Current functional status
ALAND	14	Number	Current land area
AWATER	14	Number	Current water area
INTPTLAT	11	String	Current latitude of the internal point
INTPTLON	12	String	Current longitude of the internal point

Figure 85: Appendix G-3: Census Tract State-based Shapefile Record Layout

Appendix H. Record Layouts: Congressional District Shapefile

Appendix H-1. Record Layout: 116th Congressional District Shapefile

116th Congressional District National Shapefile Record Layout

File Name: tl_YYYY_us_cd116.shp

Field	Length	Type	Description
STATEFP	2	String	Current state FIPS code
CD116FP	2	String	116th congressional district FIPS code
GEOID	4	String	116th congressional district identifier; a concatenation of current state FIPS code and the 116th congressional district FIPS code
NAMELSAD	41	String	Current name and the translated legal/statistical area description for congressional district
LSAD	2	String	Current legal/statistical area description code for congressional district
CDESSN	3	String	Congressional session code
MTFCC	5	String	MAF/TIGER Feature Class Code (G5200)
FUNCSTAT	1	String	Current functional status
ALAND	14	Number	Current land area
AWATER	14	Number	Current water area
INTPTLAT	11	String	Current latitude of the internal point
INTPTLON	12	String	Current longitude of the internal point

Figure 86: Appendix H-1: 116th Congressional District National Shapefile Record Layout

Appendix H-2. Record Layout: State Legislative District Lower Chambers (SLDL)

State Legislative District Lower Chambers (SLDL) State-based Shapefile Record Layout (Current)

File Name: tl_YYYY_<stateFIPS>_sldl.shp

Field	Length	Type	Description
STATEFP	2	String	Current state FIPS code
SLDLST	3	String	Current state legislative district lower chamber code

Field	Length	Type	Description
GEOID	5	String	State legislative district lower chamber identifier; a concatenation of the current state FIPS code and state legislative district lower chamber code
NAMELSAD	100	String	Current name and the translated legal/statistical area description for state legislative district lower chamber
LSAD	2	String	Current legal/statistical area description code for state legislative district lower chamber
LSY	4	String	Legislative session year
MTFCC	5	String	MAF/TIGER Feature Class Code (G5220)
FUNCSTAT	1	String	Current functional status
ALAND	14	Number	Current land area
AWATER	14	Number	Current water area
INTPTLAT	11	String	Current latitude of the internal point
INTPTLON	12	String	Current longitude of the internal point

Figure 87: Appendix H-2: SLDL State-based Shapefile Record Layout

Appendix H-3. Record Layout: State Legislative District Upper Chambers (SLDU) Shapefile

State Legislative District Upper Chambers (SLDU) State-based Shapefile Record Layout (Current)

File Name: tl_YYYY_<stateFIPS>_sldu.shp

Field	Length	Type	Description
STATEFP	2	String	Current state FIPS code
SLDUST	3	String	Current state legislative district upper chamber code
GEOID	5	String	State legislative district upper chamber identifier; a concatenation of the current state FIPS code and state legislative district upper chamber code
NAMELSAD	100	String	Current name and the translated legal/statistical area description for state legislative district upper chamber
LSAD	2	String	Current legal/statistical area description code for state legislative district upper chamber
LSY	4	String	Legislative session year

Field	Length	Type	Description
MTFCC	5	String	MAF/TIGER Feature Class Code (G5210)
FUNCSTAT	1	String	Current functional status
ALAND	14	Number	Current land area
AWATER	14	Number	Current water area
INTPTLAT	11	String	Current latitude of the internal point
INTPTLON	12	String	Current longitude of the internal point

Figure 88: Appendix H-3: SLDU State-based Shapefile Record Layout

Appendix I. Record Layouts: Places and County Subdivisions

Appendix I-1. Record Layout: Consolidated City Shapefile

Consolidated City Shapefile Record Layout (Current)

File Name: tl_YYYY_<stateFIPS>_concity.shp

Field	Length	Type	Description
STATEFP	2	String	Current state FIPS code
CONCTYFP	5	String	Current consolidated city FIPS code
CONCTYNS	8	String	Current consolidated city GNIS code
GEOID	7	String	Consolidated city identifier; a concatenation of current state FIPS code and consolidated city FIPS code
NAME	100	String	Current consolidated city name
NAMELSAD	100	String	Current name and the translated legal/statistical area description for consolidated city
LSAD	2	String	Current legal/statistical area description code for consolidated city
CLASSFP	2	String	Current FIPS class code
MTFCC	5	String	MAF/TIGER Feature Class Code (G4120)
FUNCSTAT	1	String	Current functional status
ALAND	14	Number	Current land area
AWATER	14	Number	Current water area

Field	Length	Type	Description
INTPTLAT	11	String	Current latitude of the internal point
INTPTLON	12	String	Current longitude of the internal point

Figure 89: Appendix I-1: Consolidated City Shapefile Record Layout

Appendix I-2. Record Layout: County and Equivalent Entity Shapefile

County and Equivalent Entity National Shapefile Record Layout (Current)

File Name: tl_YYYY_us_county.shp

Field	Length	Type	Description
STATEFP	2	String	Current state FIPS code
COUNTYFP	3	String	Current county FIPS code
COUNTYNS	8	String	ANSI feature code for the county or equivalent feature
GEOID	5	String	County identifier; a concatenation of Current state FIPS code and county FIPS code
NAME	100	String	Current county name
NAMELSAD	100	String	Current name and the translated legal/statistical area description for county
LSAD	2	String	Current legal/statistical area description code for county
CLASSFP	2	String	Current FIPS class code
MTFCC	5	String	MAF/TIGER Feature Class Code (G4020)
CSAFP	3	String	Current combined statistical area code
CBSAFP	5	String	Current metropolitan statistical area/micropolitan statistical area code
METDIVFP	5	String	Current metropolitan division code
FUNCSTAT	1	String	Current functional status
ALAND	14	Number	Current land area
AWATER	14	Number	Current water area
INTPTLAT	11	String	Current latitude of the internal point

Field	Length	Type	Description
INTPTLON	12	String	Current longitude of the internal point

Figure 90: Appendix I-2: County and Equivalent Entity National Shapefile Record Layout

Appendix I-3. Record Layout: County Subdivision State-based Shapefile

County Subdivision State-based Shapefile Record Layout (Current)

File Name: tl_YYYY_<stateFIPS>_cousub.shp

Field	Length	Type	Description
STATEFP	2	String	Current state FIPS code
COUNTYFP	3	String	Current county FIPS code
COUSUBFP	5	String	Current county subdivision FIPS code
COUSUBNS	8	String	ANSI feature code for the county subdivision
GEOID	10	String	County subdivision identifier; a concatenation of current state FIPS code, county FIPS code, and county subdivision FIPS code.
NAME	100	String	Current county subdivision name
NAMELSAD	100	String	Current name and the translated legal/statistical area description code for county subdivision
LSAD	2	String	Current legal/statistical area description code for county subdivision
CLASSFP	2	String	Current FIPS class code
MTFCC	5	String	MAF/TIGER Feature Class Code (G4040)
CNECTAFP	3	String	Current combined New England city and town area code
NECTAFP	5	String	Current New England city and town area code
NCTADVFP	5	String	Current New England city and town area division code
FUNCSTAT	1	String	Current functional status
ALAND	14	Number	Current land area
AWATER	14	Number	Current water area
INTPTLAT	11	String	Current latitude of the internal point

Field	Length	Type	Description
INTPTLON	12	String	Current longitude of the internal point

Figure 91: Appendix I-3: County Subdivision State-based Shapefile Record Layout

Appendix I-4. Record Layout: Estate Shapefile (U.S. Virgin Islands Only)

Estate Shapefile (U.S. Virgin Islands Only) Record Layout (Current)

File Name: tl_YYYY_78_estate.shp

Field	Length	Type	Description
STATEFP	2	String	Current state FIPS code (78)
COUNTYFP	3	String	Current county FIPS code 010 St. Croix 020 St. John 030 St. Thomas
ESTATEFP	5	String	Current estate FIPS code
ESTATENS	8	String	ANSI feature code for estate
GEOID	10	String	Estate identifier; a concatenation of current state FIPS code, county FIPS code, and estate FIPS code
NAME	100	String	Current estate name
NAMELSAD	100	String	Current name and the translated legal/statistical area description for estate
LSAD	2	String	Current legal/statistical area description code for estate
CLASSFP	2	String	Current FIPS class code
MTFCC	5	String	MAF/TIGER Feature Class Code (G4050)
FUNCSTAT	1	String	Current functional status
ALAND	14	Number	Current land area
AWATER	14	Number	Current water area
INTPTLAT	11	String	Current latitude of the internal point
INTPTLON	12	String	Current longitude of the internal point

Figure 92: Appendix I-4: Estate Shapefile (U.S. Virgin Islands Only) Record Layout

Appendix I-5. Record Layout: Place State-based Shapefile

Place State-based Shapefile Record Layout (Current)

File Name: tl_YYYY_<stateFIPS>_place.shp

Field	Length	Type	Description
STATEFP	2	String	Current state FIPS code
PLACEFP	5	String	Current place FIPS code
PLACENS	8	String	Current place GNIS code
GEOID	7	String	Place identifier; a concatenation of the current state FIPS code and place FIPS code
NAME	100	String	Current place name
NAMELSAD	100	String	Current name and the translated legal/statistical area description for place
LSAD	2	String	Current legal/statistical area description code for place
CLASSFP	2	String	Current FIPS class code
PCICBSA	1	String	Current metropolitan or micropolitan statistical area principal city indicator
PCINECTA	1	String	Current New England city and town area principal city indicator
MTFCC	5	String	Incorporated Place (G4110) and Census Designated Place (G4210)
FUNCSTAT	1	String	Current functional status
ALAND	14	Number	Current land area
AWATER	14	Number	Current water area
INTPTLAT	11	String	Current latitude of the internal point
INTPTLON	12	String	Current longitude of the internal point

Figure 93: Appendix I-5: Place State-based Shapefile Record Layout

Appendix I-6. Record Layout: Subbarrio Shapefile

Subbarrio (Subminor Civil Division) State-based Shapefile Record Layout (Current)

File Name: tl_YYYY_72_subbarrio.shp

Field	Length	Type	Description
STATEFP	2	String	Current state FIPS code
COUNTYFP	3	String	Current county FIPS code
COUSUBFP	5	String	Current county subdivision FIPS code
SUBMCDFP	5	String	Current subminor civil division FIPS code
SUBMCDNS	8	String	ANSI feature code for the subminor civil division
GEOID	15	String	Subminor civil division identifier; a concatenation of current state FIPS code, county FIPS code, county subdivision FIPS code, and subminor civil division FIPS code
NAME	100	String	Current subbarrio name
NAMELSAD	100	String	Current name and the translated legal/statistical area description for subbarrio
LSAD	2	String	Current legal/statistical area description code for subbarrio
CLASSFP	2	String	Current FIPS class code
MTFCC	5	String	MAF/TIGER Feature Class Code (G4060)
FUNCSTAT	1	String	Current functional status
ALAND	14	Number	Current land area
AWATER	14	Number	Current water area
INTPTLAT	11	String	Current latitude of the internal point
INTPTLON	12	String	Current longitude of the internal point

Figure 94: Appendix I-6: Subbarrio State-based Shapefile Record Layout

Appendix J. Record Layouts: Hydrography (Area and Line)

Appendix J-1. Record Layout: Area Hydrography Shapefile

Area Hydrography County-based Shapefile Record Layout

File Name: tl_YYYY_<state-countyFIPS>_areawater.shp

Field	Length	Type	Description
ANSICODE	8	String	Official code for the water body for use by federal agencies for data transfer and dissemination, if applicable
HYDROID	22	String	Area hydrography identifier
FULLNAME	100	String	Concatenation of expanded text for prefix qualifier, prefix direction, prefix type, base name, suffix type, suffix direction, and suffix qualifier (as available) with a space between each expanded text field
MTFCC	5	String	MAF/TIGER Feature Class Code
ALAND	14	Number	Land area
AWATER	14	Number	Water area
INTPTLAT	11	String	Latitude of the internal point
INTPTLON	12	String	Longitude of the internal point

Figure 95: Appendix J-1: Area Hydrography County-based Shapefile Record Layout

Appendix J-2. Record Layout: Linear Hydrography Shapefile

Linear Hydrography County-based Shapefile Record Layout

File Name: tl_YYYY_<state-countyFIPS>_linearwater.shp

Field	Length	Type	Description
ANSICODE	8	String	Official code for use by federal agencies for data transfer and dissemination, if applicable
LINEARID	22	String	Linear hydrography identifier
FULLNAME	100	String	Concatenation of expanded text for prefix qualifier, prefix direction, prefix type, base name, suffix type, suffix direction, and suffix qualifier (as available) with a space between each expanded text field

Field	Length	Type	Description
ARTPATH	1	String	Artificial path flag
MTFCC	5	String	MAF/TIGER Feature Class Code

Figure 96: Appendix J-2: Linear Hydrography County-based Shapefile Record Layout

Appendix K. Record Layout: Landmarks (Area and Point)

Appendix K-1. Record Layout: Area Landmark Shapefile

Area Landmark State-based Shapefile Record Layout

File Name: tl_YYYY_<stateFIPS>_arealm.shp

Field	Length	Type	Description
STATEFP	2	String	State FIPS code
ANSICODE	8	String	Official code for the landmark for use by federal agencies for data transfer and dissemination
AREAID	22	String	Area landmark identifier
FULLNAME	100	String	Concatenation of expanded text for prefix qualifier, prefix direction, prefix type, base name, suffix type, suffix direction, and suffix qualifier with a space between each expanded text field
MTFCC	5	String	MAF/TIGER Feature Class Code
ALAND	14	Number	Land area
AWATER	14	Number	Water area
INTPTLAT	11	String	Latitude of the internal point
INTPTLON	12	String	Longitude of the internal point
PARTFLG	1	String	Part Flag identifying if all or part of the entity is within the file

Figure 97: Appendix K-1: Area Landmark State-based Shapefile Record Layout

Appendix K-2. Record Layout: Point Landmark Shapefile

Point Landmark State-based Shapefile Record Layout

File Name: tl_YYYY_<stateFIPS>_pointlm.shp

Field	Length	Type	Description
STATEFP	2	String	State FIPS code
ANSICODE	8	String	Official code for the point landmark for use by federal agencies for data transfer and dissemination, if applicable
POINTID	22	String	Point landmark identifier
FULLNAME	100	String	Concatenation of expanded text for prefix type, base name, and suffix type with a space between each expanded text field
MTFCC	5	String	MAF/TIGER Feature Class Code

Figure 98: Appendix K-2: Point Landmark State-based Shapefile Record Layout

Appendix L. Record Layout: Linear Features Shapefile

Appendix L-1. Record Layout: All Lines County-based Shapefile

All Lines County-based Shapefile Record Layout

File Name: tl_YYYY_<state-county>_edges.shp

Field	Length	Type	Description
STATEFP	2	String	State FIPS code
COUNTYFP	3	String	County FIPS code
TLID	10	Integer	Topological Line Identifier
TFIDL	10	Integer	Topological Faces Identifier on the left of the edge
TFIDR	10	Integer	Topological Faces Identifier on the right of the edge
MTFCC	5	String	MAF/TIGER Feature Class Code of the primary feature for the edge
FULLNAME	100	String	Concatenation of expanded text for prefix qualifier, prefix direction, prefix type, base name, suffix type, suffix direction, and suffix qualifier with a space between each expanded text field (as available)

Field	Length	Type	Description
SMID	22	String	Spatial metadata identifier
LFROMADD	12	String	From house number associated with the most inclusive address range on the left side of the edge
LTOADD	12	String	To house number associated with the most inclusive address range on the left side of the edge
RFROMADD	12	String	From house number associated with the most inclusive address range on the right side of the edge
RTOADD	12	String	To house number associated with the most inclusive address range on the right side of the edge
ZIPL	5	String	ZIP Code associated with the most inclusive address range on the left side
ZIPR	5	String	ZIP Code associated with the most inclusive address range on the right side
FEATCAT	1	String	General feature classification category
HYDROFLG	1	String	Hydrography feature indicator
RAILFLG	1	String	Rail feature indicator
ROADFLG	1	String	Road feature indicator
OLFFLG	1	String	Other linear feature indicator
PASSFLG	1	String	Special passage flag
EXTTYP	1	String	Extension type
TTYP	1	String	Track type
DECKEDROAD	1	String	Decked road indicator
ARTPATH	1	String	Artificial path indicator
PERSIST	1	String	Hydrographic persistence flag
GCSEFLG	1	String	Short lines flag for geographic corridors
OFFSETL	1	String	Left offset flag
OFFSETR	1	String	Right offset flag
TNIDF	10	Integer	From TIGER node identifier

Field	Length	Type	Description
TNIDT	10	Integer	To TIGER node identifier

Figure 99: Appendix L-1: All Lines County-based Shapefile Record Layout

Appendix L-2. Record Layout: Coastlines Shapefile

Coastline National Shapefile Record Layout

File Name: tl_YYYY_us_coastline.shp

Field	Length	Type	Description
NAME	100	String	Coastline Name
MTFCC	5	String	MAF/TIGER Feature Class Code of the primary feature for the edge (L4150).

Figure 100: Appendix L-2: Coastline National Shapefile Record Layout

Appendix L-3. Record Layouts: Roads Shapefile

Appendix L-3.1 Record Layout: Roads, Primary, National Shapefile

Primary Roads National Shapefile Record Layout

File Name: tl_YYYY_us_primaryroads.shp

Field	Length	Type	Description
LINEARID	22	String	Linear feature identifier
FULLNAME	100	String	Concatenation of expanded text for prefix qualifier, prefix direction, prefix type, base name, suffix type, suffix direction, and suffix qualifier (as available) with a space between each expanded text field; display name.
RTTYP	1	String	Route type code
MTFCC	5	String	MAF/TIGER Feature Class Code (S1100)

Figure 101: Appendix L-3.1: Primary Roads National Shapefile Record Layout

Appendix L-3.2 Record Layout: Roads, Primary and Secondary State Shapefile

Primary and Secondary Roads State-based Shapefile Record Layout

File Name: tl_YYYY_<stateFIPS>_prisecroads.shp

Field	Length	Type	Description
LINEARID	22	String	Linear feature identifier
FULLNAME	100	String	Concatenation of expanded text for prefix qualifier, prefix direction, prefix type, base name, suffix type, suffix direction, and suffix qualifier (as available) with a space between each expanded text field
RTTYP	1	String	Route type code
MTFCC	5	String	MAF/TIGER Feature Class Code Primary Roads (S1100) or Secondary Roads (S1200)

Figure 102: Appendix L-3.2: Primary and Secondary Roads State-based Shapefile Record Layout

Appendix L-3.3 Record Layout: All Roads, County Shapefile

All Roads County-based Shapefile Record Layout

File Name: tl_YYYY_<state-countyFIPS>_roads.shp

Field	Length	Type	Description
LINEARID	22	String	Linear feature identifier
FULLNAME	100	String	Concatenation of expanded text for prefix qualifier, prefix direction, prefix type, base name, suffix type, suffix direction, and suffix qualifier (as available) with a space between each expanded text field
RTTYP	1	String	Route type code
MTFCC	5	String	MAF/TIGER Feature Class Code

Figure 103: Appendix L-3.3: All Roads County-based Shapefile Record Layout

Appendix L-4. Record Layout: Address Ranges Feature County Shapefile

Address Range Feature County-based Shapefile Record Layout

File Name: tl_YYYY_<state-countyFIPS>_addrfeat.shp

Field	Length	Type	Description
TLID	10	Integer	Topological Line Identifier
TFIDL	10	Integer	Topological Faces Identifier on the left of the edge
TFIDR	10	Integer	Topological Faces Identifier on the right of the edge
ARIDL	22	String	Left side Address range identifier
ARIDR	22	String	Right side Address range identifier
LINEARID	22	String	Linear feature identifier
FULLNAME	100	String	Concatenation of expanded text for prefix qualifier, prefix direction, prefix type, base name, suffix type, suffix direction, and suffix qualifier (as available) with a space between each expanded text field
LFROMHN	12	String	From House Number associated with the address range on the left side of the edge (SIDE=L)
LTOHN	12	String	To House Number associated with the address range on the left side of the edge (SIDE=L)
RFROMHN	12	String	From House Number associated with the address range on the right side of the edge (SIDE=R)
RTOHN	12	String	To House Number associated with the address range on the right side of the edge (SIDE=R)
ZIPL	5	String	ZIP code associated with the left address range
ZIPR	5	String	ZIP code associated with the right address range
EDGE_MTFCC	5	String	Primary MAF/TIGER Feature Class Code of related edge record
ROAD_MTFCC	5	String	MAF/TIGER Feature Class Code of related linear feature record
PARITYL	1	String	Left side Address Range Parity
PARITYR	1	String	Right side Address Range Parity
PLUS4L	4	String	Left side ZIP+4 Code

Field	Length	Type	Description
PLUS4R	4	String	Right side ZIP+4 Code
LFROMTYP	1	String	Left side From address range end type. If the value is "I" and the address range is an imputed value calculated by the Census Bureau at a split point then this field is loaded. Otherwise, the field is blank.
LTOTYP	1	String	Left side To address range end type. If the value is "I" and the address range is an imputed value calculated by the Census Bureau at a split point then this field is loaded. Otherwise, the field is blank.
RFROMTYP	1	String	Right side From address range end type. If the value is "I" and the address range is an imputed value calculated by the Census Bureau at a split point then this field is loaded. Otherwise, the field is blank.
RTOTYP	1	String	Right side To address range end type. If the value is "I" and the address range is an imputed value calculated by the Census Bureau at a split point then this field is loaded. Otherwise, the field is blank.
OFFSETL	1	String	Flag to designate if left side address range is on offset edge
OFFSETR	1	String	Flag to designate if right side address range is on offset edge

Figure 104: Appendix L-4: Address Range Feature County-based Shapefile Record Layout

Appendix L-5. Record Layouts: Railroads National Shapefile

Railroads National Shapefile Record Layout

File Name: tl_YYYY_us_rails.shp

Field	Length	Type	Description
LINEARID	22	String	Linear feature identifier
FULLNAME	100	String	Concatenation of expanded text for prefix qualifier, prefix direction, prefix type, base name, suffix type, suffix direction, and suffix qualifier (as available) with a space between each expanded text field
MTFCC	5	String	MAF/TIGER Feature Class Code

Figure 105: Appendix L-5: Railroads National Shapefile Record Layout

Appendix M. Record Layouts: Metropolitan and Micropolitan Shapefiles

Appendix M-1. Record Layout: CNECTA National Shapefile

Combined New England City and Town Area (CNECTA) National Shapefile Record Layout (Current)

File Name: tl_YYYY_us_cnecta.shp

Field	Length	Type	Description
CNECTAFP	3	String	Current combined New England city and town area code
GEOID	3	String	Current New England city and town area identifier; combined New England city and town area code
FNAME	100	String	Current combined New England city and town area name
NAMELSAD	100	String	Current name and the translated legal/statistical area description for combined New England city and town area
LSAD	2	String	Current legal/statistical area description code for combined New England city and town area
MTFCC	5	String	MAF/TIGER Feature Class Code (G3200)
ALAND	14	Number	Current land area
AWATER	14	Number	Current water area
INTPTLAT	11	String	Current latitude of the internal point
INTPTLON	12	String	Current longitude of the internal point

Figure 106: Appendix M-1: CNECTA National Shapefile Record Layout

Appendix M-2. Record Layout: CSA National Shapefile

Combined Statistical Area (CSA) National Shapefile Record Layout (Current)

File Name: tl_YYYY_us_csa.shp

Field	Length	Type	Description
CSAFP	3	String	Current combined statistical area code
GEOID	3	String	Combined statistical area identifier, combined statistical area code

Field	Length	Type	Description
NAME	100	String	Current combined statistical area name
NAMELSAD	100	String	Current name and the translated legal/statistical area description for combined statistical area
LSAD	2	String	Current legal/statistical area description code for combined statistical area
MTFCC	5	String	MAF/TIGER Feature Class Code (G3100)
ALAND	14	Number	Current land area
AWATER	14	Number	Current water area
INTPTLAT	11	String	Current latitude of the internal point
INTPTLON	12	String	Current longitude of the internal point

Figure 107: Appendix M-2: CSA National Shapefile Record Layout

Appendix M-3. Record Layout: Metropolitan Division National Shapefile

Metropolitan Division National Shapefile Record Layout (Current)

File Name: tl_YYYY_us_metdiv.shp

Field	Length	Type	Description
CSAFP	3	String	Current combined statistical area code
CBSAFP	5	String	Current metropolitan statistical area/micropolitan statistical area code
METDIVFP	5	String	Current metropolitan division code
GEOID	10	String	Metropolitan division identifier; a concatenation of metropolitan statistical area/micropolitan statistical area code and metropolitan division code
NAME	100	String	Current metropolitan division name
NAMELSAD	100	String	Current name and the translated legal/statistical area description for metropolitan division
LSAD	2	String	Current legal/statistical area description code for metropolitan division
MTFCC	5	String	MAF/TIGER Feature Class Code (G3120)

Field	Length	Type	Description
ALAND	14	Number	Current land area
AWATER	14	Number	Current water area
INTPTLAT	11	String	Current latitude of the internal point
INTPTLON	12	String	Current longitude of the internal point

Figure 108: Appendix M-3: Metropolitan Division National Shapefile Record Layout

Appendix M-4. Record Layout: CBSA National Shapefile

Metropolitan Statistical Area/Micropolitan Statistical Area (CBSA) National Shapefile Record Layout (Current)

File Name: tl_YYYY_us_cbsa.shp

Field	Length	Type	Description
CSAFP	3	String	Current combined statistical area code, if applicable
CBSAFP	5	String	Current metropolitan statistical area/micropolitan statistical area code
GEOID	5	String	Metropolitan statistical area/micropolitan statistical area identifier, metropolitan statistical area/micropolitan statistical area code
NAME	100	String	Current metropolitan statistical area/micropolitan statistical area name
NAMELSAD	100	String	Current name and the translated legal/statistical area description for metropolitan statistical area/micropolitan statistical area
LSAD	2	String	Current legal/statistical area description code for metropolitan statistical area/micropolitan statistical area
MEMI	1	String	Current metropolitan/micropolitan status indicator
MTFCC	5	String	MAF/TIGER Feature Class Code (G3110)
ALAND	14	Number	Current land area
AWATER	14	Number	Current water area
INTPTLAT	11	String	Current latitude of the internal point
INTPTLON	12	String	Current longitude of the internal point

Figure 109: Appendix M-4: CBSA National Shapefile Record Layout

Appendix M-5. Record Layout: New England City and Town Area (NECTA) Shapefile

New England City and Town Area (NECTA) National Shapefile Record Layout (Current)

File Name: tl_YYYY_us_necta.shp

Field	Length	Type	Description
CNECTAFP	3	String	Current combined New England City and Town Area code, if applicable
NECTAFP	5	String	Current New England City and Town area code
GEOID	5	String	New England city and town area identifier, New England city and town area code
NAME	100	String	Current New England city and town area name
NAMELSAD	100	String	Current name and the translated legal/statistical area description for New England city and town area
LSAD	2	String	Current legal/statistical area description code for New England city and town area
NMEMI	1	String	Current New England city and town area metropolitan/micropolitan status indicator
MTFCC	5	String	MAF/TIGER Feature Class Code (G3210)
ALAND	14	Number	Current land area
AWATER	14	Number	Current water area
INTPTLAT	11	String	Current latitude of the internal point
INTPTLON	12	String	Current longitude of the internal point

Figure 110: Appendix M-5: NECTA National Shapefile Record Layout

Appendix M-6. Record Layout: NECTA Division National Shapefile

New England City and Town Area (NECTA) Division National Shapefile Record Layout (Current)

File Name: tl_YYYY_us_nectadiv.shp

Field	Length	Type	Description
CNECTAFP	3	String	Current combined New England City and Town Area code, if applicable
NECTAFP	5	String	Current New England City and Town Area code

Field	Length	Type	Description
NCTADVFP	5	String	Current New England City and Town Area division code
GEOID	10	String	New England City and Town Area division identifier; a concatenation of New England city and town area code and New England city and town area division code
NAME	100	String	Current New England City and Town Area division name
NAMELSAD	100	String	Current name and the translated legal/statistical area description for New England City and Town area division
LSAD	2	String	Current legal/statistical area description code for New England City and Town area division
MTFCC	5	String	MAF/TIGER Feature Class Code (G3220)
ALAND	14	Number	Current land area
AWATER	14	Number	Current water area
INTPTLAT	11	String	Current latitude of the internal point
INTPTLON	12	String	Current longitude of the internal point

Figure 111: Appendix M-6: NECTA Division National Shapefile Record Layout

Appendix N. Record Layout: Military Installation National Shapefile

Military Installation National Shapefile Record Layout

File Name: tl_YYYY_us_mil.shp

Field	Length	Type	Description
ANSICODE	8	String	Official code for the landmark for use by federal agencies for data transfer and dissemination
AREAID	22	String	Area landmark identifier
FULLNAME	100	String	Concatenation of expanded text for prefix qualifier, prefix direction, prefix type, base name, suffix type, suffix direction, and suffix qualifier (as available) with a space between each expanded text field
MTFCC	5	String	MAF/TIGER Feature Class Code
ALAND	14	Number	Land area
AWATER	14	Number	Water area

Field	Length	Type	Description
INTPTLAT	11	String	Latitude of the internal point
INTPTLON	12	String	Longitude of the internal point

Figure 112: Appendix N: Military Installation National Shapefile Record Layout

Appendix O. Record Layouts: PUMA's, Urban Areas, ZCTA Shapefiles

Appendix O-1. Record Layout: Public Use Microdata Area State-based Shapefile

Public Use Microdata Area (PUMA) State-based Shapefile Record Layout (2010 Census)

File Name: tl_YYYY_<stateFIPS>_puma10.shp

Field	Length	Type	Description
STATEFP10	2	String	2010 Census state FIPS code
PUMACE10	5	String	2010 Census Public Use Microdata Area code
GEOID10	7	String	2010 Census nation-based Public Use Microdata Area code; a concatenation of 2010 Census state FIPS code and Public Use Microdata Area code
NAMELSAD10	100	String	2010 Census translated legal/statistical area description code and Public Use Microdata Area name
MTFCC10	5	String	MAF/TIGER Feature Class Code (G6120)
FUNCSTAT10	1	String	2010 Census functional status
ALAND10	14	Number	2010 Census land area
AWATER10	14	Number	2010 Census water area
INTPTLAT10	11	String	2010 Census latitude of the internal point
INTPTLON10	12	String	2010 Census longitude of the internal point

Figure 113: Appendix O-1: Public Use Microdata Area (PUMA) State-based Shapefile Record Layout

Appendix O-2. Record Layout: Urban Areas National Shapefile

Urban Area (UA) National Shapefile Record Layout (2010 Census)

File Name: tl_YYYY_us_uac10.shp

Field	Length	Type	Description
UACE10	5	String	2010 Census urban area code
GEOID10	5	String	2010 Census urban area identifier; 2010 Census urban area code
NAME10	100	String	2010 Census urban area name
NAMELSAD10	100	String	2010 Census name and the translated legal/statistical area description for urban area
LSAD10	2	String	2010 Census legal/statistical area description code for urban area
MTFCC10	5	String	MAF/TIGER Feature Class Code (G3500)
UATYP10	1	String	2010 Census urban area type
FUNCSTAT10	1	String	2010 Census functional status
ALAND10	14	Number	2010 Census land area
AWATER10	14	Number	2010 Census water area
INTPTLAT10	11	String	2010 Census latitude of the internal point
INTPTLON10	12	String	2010 Census longitude of the internal point

Figure 114: Appendix O-2: Urban Area (UA) National Shapefile Record Layout

Appendix O-3. Record Layout: 5 Digit ZIP Code Tabulation (ZCTA5) National Shapefile

5-Digit ZIP Code Tabulation Area (ZCTA5) National Shapefile Record Layout (2010 Census)

File Name: tl_YYYY_us_zcta510.shp

Field	Length	Type	Description
ZCTA5CE10	5	String	2010 Census 5-digit ZIP Code Tabulation Area code
GEOID10	5	String	2010 Census 5-digit ZIP Code Tabulation Area code
CLASSFP10	2	String	2010 Census FIPS 55 class code
MTFCC10	5	String	MAF/TIGER Feature Class Code (G6350)

Field	Length	Type	Description
FUNCSTAT10	1	String	2010 Census functional status
ALAND10	14	Number	2010 Census land area
AWATER10	14	Number	2010 Census water area
INTPTLAT10	11	String	2010 Census latitude of the internal point
INTPTLON10	12	String	2010 Census longitude of the internal point

Figure 115: Appendix O-3: ZCTA5 National Shapefile Record Layout

Appendix P. Record Layouts: School Districts Shapefiles

Appendix P-1. Record Layout: Elementary School District State Shapefile

Elementary School District State-based Shapefile Record Layout (Current)

File Name: tl_YYYY_<stateFIPS>_elsd.shp

Field	Length	Type	Description
STATEFP	2	String	Current state FIPS code
ELSDLEA	5	String	Current elementary school district local education agency code
GEOID	7	String	School district identifier; a concatenation of the current state FIPS code and elementary school district local education agency code
NAME	100	String	Current elementary school district name
LSAD	2	String	Current legal/statistical area description code for elementary school district
LOGRADE	2	String	Current lowest grade covered by school district
HIGRADE	2	String	Current highest grade covered by school district
MTFCC	5	String	MAF/TIGER Feature Class Code (G5400)
SDTYP	1	String	Current school district type
FUNCSTAT	1	String	Current functional status
ALAND	14	Number	Current land area
AWATER	14	Number	Current water area

Field	Length	Type	Description
INTPTLAT	11	String	Current latitude of the internal point
INTPTLON	12	String	Current longitude of the internal point

Figure 116: Appendix P-1: Elementary School District State-based Shapefile Record Layout

Appendix P-2. Record Layout: Secondary School District State Shapefile

Secondary School District State-based Shapefile Record Layout (Current)

File Name: tl_YYYY_<stateFIPS>_scsd.shp

Field	Length	Type	Description
STATEFP	2	String	Current state FIPS code
SCSDLEA	5	String	Current secondary school district local education agency code
GEOID	7	String	School district identifier; a concatenation of the current state FIPS code and secondary school district local education agency code
NAME	100	String	Current secondary school district name
LSAD	2	String	Current legal/statistical area description code for secondary school district
LOGRADE	2	String	Current lowest grade covered by school district
HIGRADE	2	String	Current highest grade covered by school district
MTFCC	5	String	MAF/TIGER Feature Class Code (G5410)
SDTYP	1	String	Current school district type
FUNCSTAT	1	String	Current functional status
ALAND	14	Number	Current land area
AWATER	14	Number	Current water area
INTPTLAT	11	String	Current latitude of the internal point
INTPTLON	12	String	Current longitude of the internal point

Figure 117: Appendix P-2: Secondary School District State-based Shapefile Record Layout

Appendix P-3. Record Layout: Unified School District State Shapefile

Unified School District State-based Shapefile Record Layout (Current)

File Name: tl_YYYY_<stateFIPS>_unsd.shp

Field	Length	Type	Description
STATEFP	2	String	Current state FIPS code
UNSDLEA	5	String	Current unified school district local education agency code
GEOID	7	String	School district identifier; a concatenation of the current state FIPS code and unified school district local education agency code
NAME	100	String	Current unified school district name
LSAD	2	String	Current legal/statistical area description code for unified school district
LOGRADE	2	String	Current lowest grade covered by school district
HIGRADE	2	String	Current highest grade covered by school district
MTFCC	5	String	MAF/TIGER Feature Class Code (G5420)
SDTYP	1	String	Current school district type
FUNCSTAT	1	String	Current functional status
ALAND	14	Number	Current land area
AWATER	14	Number	Current water area
INTPTLAT	11	String	Current latitude of the internal point
INTPTLON	12	String	Current longitude of the internal point

Figure 118: Appendix P-3: Unified School District State-based Shapefile Record Layout

Appendix P-4. Record Layout: State and Equivalent Entity National Shapefile

State and Equivalent Entity National Shapefile Record Layout (Current)

File Name: tl_YYYY_us_state.shp

Field	Length	Type	Description
REGION	2	String	Current region code
DIVISION	2	String	Current division code
STATEFP	2	String	Current state FIPS code
STATENS	8	String	ANSI feature code for the state or equivalent entity
GEOID	2	String	State identifier; state FIPS code
STUSPS	2	String	Current United States Postal Service state abbreviation
NAME	100	String	Current state name
LSAD	2	String	Current legal/statistical area description code for state
MTFCC	5	String	MAF/TIGER Feature Class Code (G4000)
FUNCSTAT	1	String	Current functional status
ALAND	14	Number	Current land area
AWATER	14	Number	Current water area
INTPTLAT	11	String	Current latitude of the internal point
INTPTLON	12	String	Current longitude of the internal point

Figure 119: Appendix P-4: State and Equivalent Entity National Shapefile Record Layout

Appendix Q. Record Layout: Topological Faces County Shapefile

Topological Faces (Polygons with All Geocodes) County-based Shapefile Record Layout (Current)

File Name: tl_YYYY_<state-countyFIPS>_faces.shp

Field	Length	Type	Description
TFID	10	Integer	Topological Faces Identifier
STATEFP10	2	String	2010 Census state FIPS code
COUNTYFP10	3	String	2010 Census county FIPS code

Field	Length	Type	Description
TRACTCE10	6	String	2010 Census tract code
BLKGRPCE10	1	String	2010 Census block group number
BLOCKCE10	4	String	2010 Census tabulation block number
SUFFIX1CE	1	String	Current Census block suffix 1
ZCTA5CE10	5	String	2010 Census 5-digit ZCTA code
UACE10	5	String	2010 Census urban area code
PUMACE10	5	String	2010 Census public use microdata area code
STATEFP	2	String	Current state FIPS code
COUNTYFP	3	String	Current county FIPS code
TRACTCE	6	String	Current census tract code
BLKGRPCE	1	String	Current block group number
COUSUBFP	5	String	Current county subdivision FIPS code
SUBMCDFP	5	String	Current subminor civil division FIPS code
ESTATEFP	5	String	Current estate FIPS code
CONCTYFP	5	String	Current consolidated city FIPS code
PLACEFP	5	String	Current place FIPS code
AIANNHFP	5	Number	Current American Indian/Alaska Native/Native Hawaiian area FIPS code
AIANNHCE	4	String	Current American Indian/Alaska Native/Native Hawaiian area census code
COMPTYP	1	String	Current American Indian/Alaska Native/Native Hawaiian area reservation/statistical area or off-reservation trust land Hawaiian home land indicator
TRSUBFP	5	Number	Current American Indian Tribal Subdivision FIPS code
TRSUBCE	3	String	Current American Indian Tribal Subdivision code
ANRCFP	5	String	Current Alaska Native Regional Corporation FIPS code
TTRACTCE	6	String	Current tribal census tract code

Field	Length	Type	Description
TBLKGPCE	1	String	Current tribal block group letter
ELSDLEA	5	String	Current elementary school district local education agency code
SCSDLEA	5	String	Current secondary school district local education agency code
UNSDLEA	5	String	Current unified school district local education agency code
CD116FP	2	String	116th congressional district FIPS code
SLDUST	3	String	Current state legislative district upper chamber code
SLDLST	3	String	Current state legislative district lower chamber code
CSAFP	3	String	Current combined statistical area code
CBSAFP	5	String	Current metropolitan statistical area/micropolitan statistical area code
METDIVFP	5	String	Current Metropolitan division code
CNECTAFP	3	String	Current combined New England city and town area code (New England states only)
NECTAFP	5	String	Current New England city and town area code (New England states only)
NCTADVFP	5	String	Current New England city and town area division code (New England states only)
LWFLAG	1	String	Land/water flag
OFFSET	1	String	Geographic corridor/offset flag
ATOTAL	14	Number	Total area
INTPTLAT	11	String	Latitude of the internal point
INTPTLON	12	String	Longitude of the internal point

Figure 120: Appendix Q: Topological Faces - Polygons All Geocodes County-based Shapefile Record Layout

Appendix R. Record Layouts: Relationship Files Shapefile

Appendix R-1. Record Layout: Address Range County-based Relationship File

Address Ranges County-based Relationship File Record Layout (Current)

File Name: tl_YYYY_<state-county FIPS>_addr.dbf

Field	Length	Type	Description
TLID	10	Integer	Topological Line Identifier
FROMHN	12	String	From house number
TOHN	12	String	To house number
SIDE	1	String	Side Indicator flag
ZIP	5	String	5-digit ZIP Code
PLUS4	4	String	ZIP+4 Code
FROMTYP	1	String	From address range end type
TOTYP	1	String	To address range end type
ARID	22	String	Address range identifier
MTFCC	5	String	MAF/TIGER Feature Class Code

Figure 121: Address Ranges County-based Relationship File Record Layout

Appendix R-2. Record Layout: Address Range Feature Name County Relationship File

Address Range-Feature Name County-based Relationship File Record Layout (Current)

File Name: tl_YYYY_<state-county FIPS>_addrfn.dbf

Field	Length	Type	Description
ARID	22	String	Address range identifier
LINEARID	22	String	Linear feature identifier

Figure 122: Appendix R-2: Address Range-Feature Name County-based Relationship File Record Layout

Appendix R-3. Record Layout: Feature Names County based Relationship File

Feature Names County-based Relationship File Record Layout

File Name: tl_YYYY_<state-county FIPS>_featnames.dbf

Field	Length	Type	Description
TLID	10	Integer	Topological Line Identifier
FULLNAME	100	String	Concatenation of expanded text for prefix qualifier, prefix direction, prefix type, base name, suffix type, suffix direction, and suffix qualifier (as available) with a space between each expanded text field
NAME	100	String	Base name portion of the standardized name
PREDIRABRV	15	String	Prefix direction description component of the feature name
PRETYPABRV	50	String	Prefix type description component of the feature name
PREQUALABR	15	String	Prefix qualifier description component of the feature name
SUFDIRABRV	15	String	Suffix direction description component of the feature name
SUFTYPABRV	50	String	Suffix type description component of the feature name
SUFQUALABR	15	String	Suffix qualifier description component of the feature name
PREDIR	2	String	prefix direction code component of the feature name
PRETYP	3	String	prefix type code description component of the feature name
PREQUAL	2	String	prefix qualifier code component of the feature name
SUFDIR	2	String	suffix direction code component of the feature name
SUFTYP	3	String	suffix type code description component of the feature name
SUFQUAL	2	String	suffix qualifier code component of the feature name
LINEARID	22	String	Linear feature identifier
MTFCC	5	String	MAF/TIGER Feature Class Code
PAFLAG	1	String	primary/alternate flag

Figure 123: Appendix R-3: Feature Names County-based Relationship File Record Layout

Appendix R-4. Record Layouts: Topological Faces Relationship Files

Appendix R-4.1 Record Layout: Topological Faces Area Landmark County Relationship File

Topological Faces-Area Landmark County-based Relationship File Record Layout

File Name: tl_YYYY_<state FIPS>_facesal.dbf

Field	Length	Type	Description
TFID	10	Integer	Topological Faces Identifier
AREAID	22	String	Area landmark identifier

Figure 124: Appendix R-4.1: Topological Faces-Area Landmark County-based Relationship File Record Layout

Appendix R-4.2 Record Layout: Topological Faces Area Hydrography County Relationship

Topological Faces-Area Hydrography County-based Relationship File Record Layout (Current)

File Name: tl_YYYY_<state-county FIPS>_facesah.dbf

Field	Length	Type	Description
TFID	10	Integer	Topological Faces Identifier
HYDROID	22	String	Area Hydrography identifier

Figure 125: Appendix R-4.2: Topological Faces-Area Hydrography County-based Relationship File Record Layout

Appendix R-4.3 Record Layout: Topological Faces Area Military Installation National Relationship

Topological Faces-Military Installation National Relationship File Record Layout (Current)

File name: tl_YYYY_us_facesmil.dbf

Field	Length	Type	Description
TFID	10	Integer	Topological Faces Identifier
AREAID	22	String	Area Landmark identifier

Figure 126: Appendix R-4.3: Topological Faces-Military Installation National Relationship File Record Layout

Appendix S. Shapefile and Relationship File Names

File Name	Shapefile and Relationship File Description
ADDR	Address Range Relationship File
ADDRFEAT	Address Range Feature
ADDRFN	Address Range-Feature Name Relationship
AIANNH	American Indian / Alaska Native / Native Hawaiian Areas
AITSN	American Indian Tribal Subdivision National
ANRC	Alaska Native Regional Corporation
AREALM	Area Landmark
AREAWATER	Area Hydrography
BG	Block Group
CBSA	Metropolitan Statistical Area / Micropolitan Statistical Area
CD	Congressional District
CNECTA	Combined New England City and Town Area
COASTLINE	Coastline
CONCITY	Consolidated City
COUNTY	County
COUSUB	County Subdivision
CSA	Combined Statistical Area
EDGES	All Lines
ELSD	Elementary School District
ESTATE	Estate (U.S. Virgin Islands only)
FACES	Topological Faces (Polygons with All Geocodes)
FACESAH	Topological Faces-Area Hydrography Relationship File
FACESAL	Topological Faces-Area Landmark Relationship File
FACESMIL	Topological Faces-Military Installation Relationship File
FEATNAMES	Feature Names Relationship File
LINEARWATER	Linear Hydrography
METDIV	Metropolitan Division
MIL	Military Installation
NECTA	New England City and Town Area
NECTADIV	New England City and Town Area Division
PLACE	Place
POINTLM	Point Landmark
PRIMARYROADS	Primary Roads
PRISECROADS	Primary and Secondary Roads
PUMA	Public Use Microdata Area
RAILS	Railroads
ROADS	All Roads
SCSD	Secondary School Districts
SLDL	State Legislative District – Lower Chamber
SLDU	State Legislative District – Upper Chamber
STATE	State and Equivalent
SUBMCD	Subminor Civil Division (Subbarrio in Puerto Rico)
TABBLOCK	Tabulation (Census) Block
TBG	Tribal Block Group
TRACT	Census Tract
TTRACT	Tribal Census Tract
UAC	Urban Area/Urban Cluster
UNSD	Unified School District
ZCTA5	5-Digit ZIP Code Tabulation Area

Figure 127: Appendix S: Shapefile and Relationship File Names

The files names are tl_YYYY_<geographic area>_<filename>.zip.

Geographic Area values

Type	Value
National based file	"us"
State based file	2 characters FIPS code
County based file	5 characters FIPS codes (state and county) <ul style="list-style-type: none">• 2 characters state FIPS code• 3 characters county FIPS code

Figure 128: Geographic Area values

State and county FIPS codes

<

<<https://www.census.gov/geographies/reference-files/2019/demo/popest/2019-fips.html>>

Appendix T. Glossary

Acronym or Term	Definition
ACS	American Community Survey
ANSI	American National Standards Institute
ANSI codes	Standardized set of numeric or alphabetic codes issued by the ANSI to ensure uniform identification of geographic entities through all federal government agencies.
Address Range	Collection of all possible structure house numbers, from the first structure house number to the last structure house number of a specified parity along an edge side relative to the direction of the edge.
AIANNH	American Indian/Alaska Native/Native Hawaiian
AIR	American Indian Reservations
AITs	American Indian Tribal Subdivisions are legally defined administrative subdivisions of federally recognized American Indian Reservations and/or Off-Reservation Trust Lands or Oklahoma Tribal Statistical Areas (OTSA's).
ANRC	Alaska Native Regional Corporation
ANV	Alaska Native village
ANVSA	Alaska Native village Statistical Areas
AREAID	Area Landmark Identifier
ARID	Address Range Identifier
ASCII	American Standard Code for Information Interchange
BAS	Boundary and Annexation Survey
BG	Block Group
BIA	Bureau of Indian Affairs
CBSA	Core-based Statistical Area
CCD	Census County Divisions
CDP	Census Designated Places
CE	Census
CNECTA	Combined New England City and Town Areas
CPG	Identify character encoding
CQR	Count Question Resolution
CSA	Combined Statistical Areas
DATUM	The horizontal datum, which corresponds to the procedure used to measure positions on the surface of the Earth.
DBF	Tabular attribute information Database
DIME	Dual Independent Map Encoding
DLG	Digital Line Graph
Elementary School Districts	Provide education to the lower grade/age levels and secondary school districts provide education to the upper grade/age levels.
Esri	Environmental Systems Research Institute
FP	FIPS Codes
FIPS	Federal Information Processing Series
FTP	File Transfer Protocol
GBF	Geographic Base Files
GEOGCS	A coordinate system based on based on latitude and longitude.
GEOID	Geographic Identifier
GIS	Geographic Information System
GNIS	Geographic Names Information System
HHL	Hawaiian home lands
ISO	International Organization for Standardization
KG	Kindergarten

Acronym or Term	Definition
KML	Keyhole Markup Language is a file format used to display geographic data in a tool (e.g., Google Earth and Google Maps).
LEA	Local Education Agency codes
Legal Entity	A geographic entity whose boundaries, name, origin, and area description result from charters, laws, treaties, or other administrative or governmental action.
LSAD	Legal/Statistical Area Description
MCD	Minor Civil Division
MPO	Metropolitan Planning Organizations
MTDB	MAF/TIGER Database
MTFCC	MAF/TIGER Feature Class Code
NECTA	New England City and Town Area
NAD83	North American Datum of 1983
NHD	USGS National Hydrographic Dataset
NS	National Standard
OMB	U.S. Office of Management and Budget
ORTL	Off-Reservation Trust Lands
OTSA	Oklahoma Tribal Statistical Areas
PK	Pre-Kindergarten
P.L.	Public Law
P.O. Box	Post Office Box
PRIMEM	The prime meridian used to take longitude measurements (from). The longitude units will match those of the geographic coordinate system.
PRJ	Project File
PSAP	Participant Statistical Areas Program
PUMA	Public Use Microdata Area
School Districts	Single-purpose administrative units within which local officials provide public educational services for the area's residents.
SDC	State Data Centers
SDTSA	State Designated Tribal Statistical Areas
SDAISA	State Designated American Indian Statistical Areas
SDTYP	School District Type
Shapefiles	Digital representations of geographic features (e.g., lakes, landmarks, roads and boundaries) used to create maps.
SLD	State Legislative District
SLDL	State Legislative District Lower Chamber
SLDU	State Legislative District Upper Chamber
SMID	Spatial Metadata Identifier
SPHEROID	An approximation of the Earth's surface as a squashed sphere.
Statistical Entity	Any geographic entity or combination of entities identified and defined solely for the tabulation and presentation of data.
TDSA	Tribal Designated Statistical Areas
TFID	Topological Faces Identifier
TFIDL	Topological Faces Identifier on the left side of the edge
TFIDR	Topological Faces Identifier on the right side of the edge
TIGER	Census Bureau's Topologically Integrated Geographic Encoding and Referencing
TLID	Topological Line Identifier
TSAP	Tribal Statistical Areas Program
UA	Urbanized Area consists of densely developed territory that contains 50,000 or more people. The Census Bureau delineates UAs to provide a better separation of urban and rural territory, population, and housing surrounding large places.
UC	Urban Cluster consists of densely developed territory that has 2,500 but fewer than 50,000 people. The Census Bureau first introduced the UC concept for Census 2000 to provide a more consistent and accurate measure of urban population, housing, and

Acronym or Term	Definition
	territory throughout the United States, Puerto Rico, and the Island Areas. The Census Bureau identifies all qualifying urban areas in Guam, the Commonwealth of the Northern Mariana Islands, and the U.S. Virgin Islands as urban clusters based on agreements with the local governments. Thus, in the Island Areas, urban clusters may exceed 50,000 people.
UNIT	This describes units used for values elsewhere within the parent WKT clause. The physical dimension (i.e. type) of the units determined by context. For example, the type of the units is angular.
U.S.C.	United States Code
USGS	U.S. Geological Survey
USPS	U.S. Postal Service
USVI	United States Virgin Islands
UT	Unorganized Territories
WKT	well-known text
XML	Extensible Markup Language
ZCTA	ZIP Code Tabulation Areas are approximate area representations of U.S. Postal Service (USPS) 5-digit ZIP Code service areas that the Census Bureau creates using census blocks to present statistical data from censuses and surveys.
ZCTA5	5-digit Zip Code Tabulation Areas

Figure 129: Appendix T: Glossary